



High Color • Wide Screen •
User-Friendly HMI Products

DOP-B10

No.18, Xinglong Rd., Taoyuan City
33068, Taiwan

Instruction Sheet

(1) Preface

Thank you for purchasing DELTA's DOP-B series. This instruction sheet will be helpful in the installation, wiring and inspection of Delta HMI. Before using the product, please read this instruction sheet to ensure correct use. You should thoroughly understand all safety precautions before proceeding with the installation, wiring and operation. Place this instruction sheet in a safe location for future reference. Please observe the following precautions:

- Install the product in a clean and dry location free from corrosive and inflammable gases or liquids.
- Ensure that all wiring instructions and recommendations are followed.
- Ensure that HMI is correctly connected to a ground. The grounding method must comply with the electrical standard of the country (Please refer to NFPA 70: National Electrical Code, 2005 Ed.).
- Do not disassemble HMI, modify or remove wiring when power is applied to HMI.
- Do not touch the power supply during operation. Otherwise, it may cause electric shock.

If you have any questions during operation, please contact our local distributors or Delta sales representatives.

The content of this instruction sheet may be revised without prior notice. Please consult our distributors or download the most updated version at <http://www.delta.com.tw/ia>.

(2) Pin Definition of Serial Communication

DOP-B10S411 / DOP-B10S511/ DOP-B10E515 COM1 Port

COM Port	PIN	MODE1 RS-232
	1	
	2	RXD
	3	TXD
	4	
	5	GND
	6	
	7	RTS
	8	CTS
	9	

Note1: Blank = To avoid malfunction, it must be left unconnected.

DOP-B10S411 / DOP-B10S511 COM2 Port

COM Port	PIN	MODE1		MODE2		MODE3	
		COM2 RS-232	COM3 RS-232	COM2 RS-485	COM3 RS-485	COM2 -	COM3 RS-422
	1			D+			TXD+
	2	RXD					
	3	TXD					
	4				D+		RXD+
	5	GND		GND		GND	
	6				D-		TXD-
	7		TXD				
	8		RXD				
	9				D-		RXD-

Note1: Note1: Blank = To avoid malfunction, it must be left unconnected.

Note2: DOP-B10S411 / DOP-B10S511 models do not support RS-422 flow control.

DOP-B10E515 COM2 Port

COM Port	PIN	MODE1 RS-232	MODE2 RS-422	MODE3 RS-485
	1		TXD+	D+
	2	RXD		
	3	TXD		
	4		RXD+	
	5	GND	GND	GND
	6		TXD-	D-
	7	RTS		
	8	CTS		
	9		RXD-	

Note1: Note1: Blank = To avoid malfunction, it must be left unconnected.

Note2: When COM2 port is used for RS-232 flow control (RTS, CTS is set), COM3 port cannot be used.

Note3: When COM2 port is used for RS-422 flow control, for the pin settings it needs, please refer to the pin definitions of MODE 2 in DOP-B10E515 COM3 port table.

DOP-B10E515 COM3 Port

COM Port	PIN	MODE1 RS-232	MODE2 RS-422	MODE3 RS-485
	1		TXD+(RTS+)	D+
	2	RXD		
	3	TXD		
	4		RXD+(CTS+)	
	5	GND	GND	GND
	6		TXD-(RTS-)	D-
	7			
	8			
	9		RXD-(CTS-)	

Note1: Note1: Blank = To avoid malfunction, it must be left unconnected.

Note2: When COM2 port is used for RS-422 flow control, for the pin settings it needs, please refer to the pin definitions of MODE 2 in DOP-B10E515 COM3 port table.

(3) Parts Names

DOP-B10S411 (Front View)

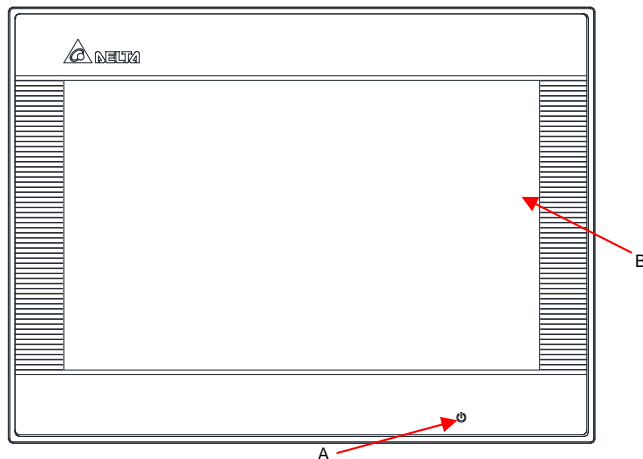

A	Power LED Indicator (🔆)	Note: 🔆 Lights in green when HMI works normally.
B	Touch Screen / Display	

DOP-B10S411 (Rear View)

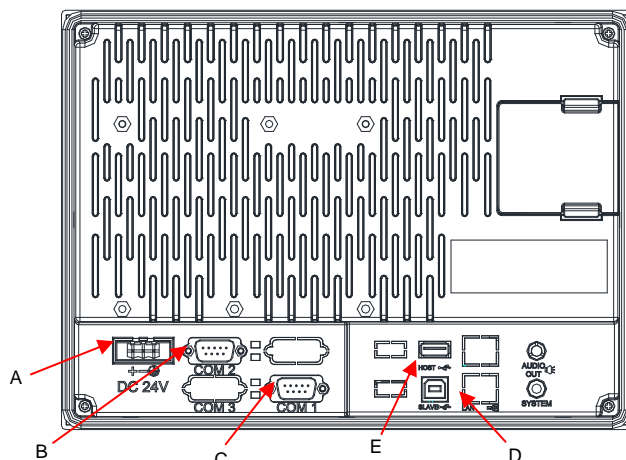

A	Power Input Terminal	D	USB Slave
B	COM2	E	USB Host
C	COM1	Please note DOP-B10S411 model has not system key, user could press at blank space for 3 seconds, and then will hear Buzzer sound. After hearing the Buzzer sounded, please press left top corner to enter system menu.	

DOP-B10S511 / DOP-B10E515 (Front View)

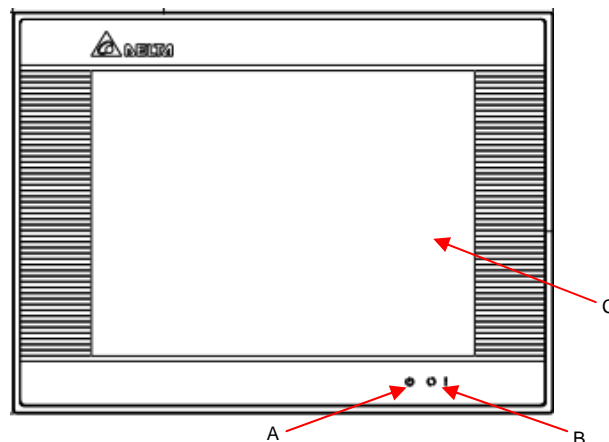

A	Power LED Indicator (🔆)	🔆 Lights in green when HMI works normally.
B	Operation LED Indicator (🔆) / Alarm LED Indicator (🔴)	🔆 Lights in blue: the communication is carried out / the data is accessing. (Please refer to the "Note" below for explanation). 🔴 Lights in red: one of the alarms is on.
C	Touch Screen / Display	Note: The definition of the operation LED indicator (Blue) can be determined by the users freely.

Please note that DOP-B10S511 model only has Power LED Indicator (A) and Touch Screen / Display (C).

DOP-B10S511 / DOP-B10E515 (Rear View)

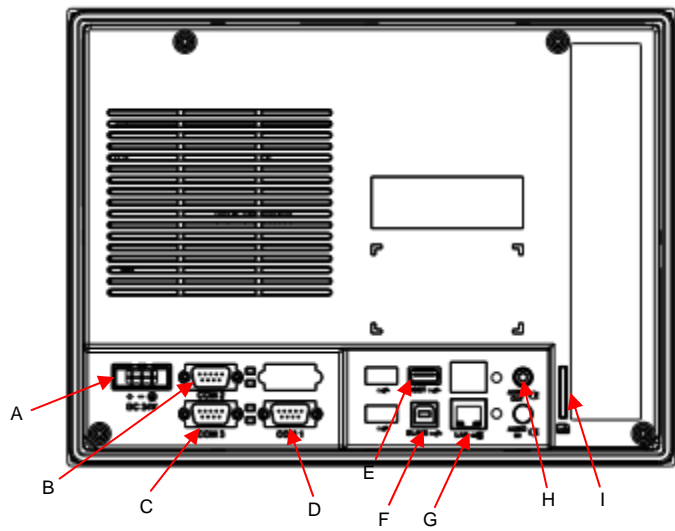

A	Power Input Terminal	F	USB Slave
B	COM2 (It is provided with two LED indicators to indicate that HMI is in Read or Write status during the communication process.)	G	Ethernet Interface (LAN) Note: DOP-B10E515 only.
C	COM3 (It is provided with two LED indicators to indicate that HMI is in Read or Write status during the communication process.) Note: DOP-B10E515 only.	H	Audio Output Interface Note: DOP-B10E515 only.
D	COM1	I	Memory Card Slot Note: DOP-B10E515 only.
E	USB Host	Please note DOP-B10S511 / DOP-B10E515 model has not system key, user could press at blank space for 3 seconds, and then will hear Buzzer sound. After hearing the Buzzer sounded, please press left top corner to enter system menu.	

(4) Dimensions

DOP-B10S411

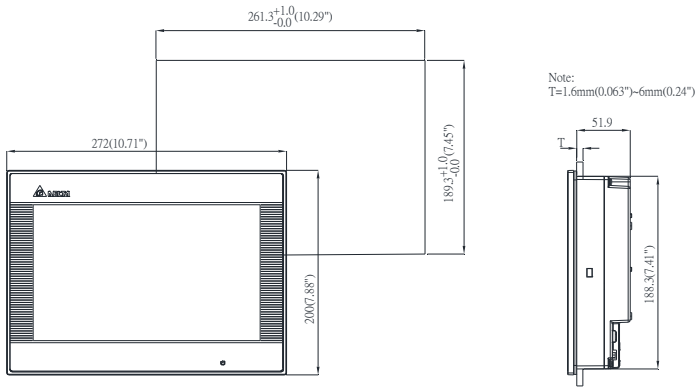

DOP-B10S511 / DOP-B10E515

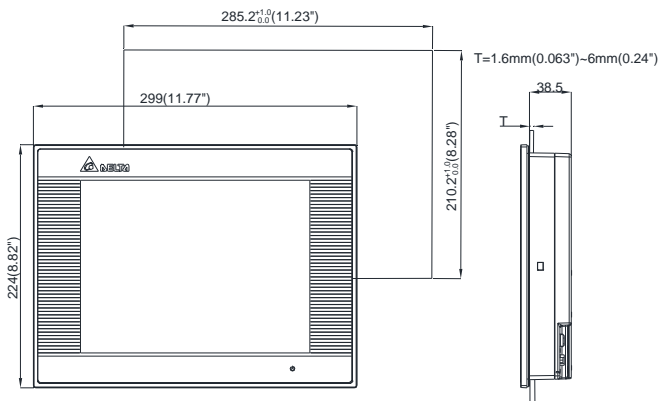

(5) Specifications

Model Name		DOP-B10S411	DOP-B10S511	DOP-B10E515
LCD MODULE	Display Type	10.1" Widescreen TFT LCD (65536 colors)	10.4" TFT LCD (65536 colors)	10.4" TFT LCD (65536 colors)
	Resolution	800 x 480 pixels	800 x 600 pixels	800 x 600 pixels
	Backlight	LED Back Light (less than 20,000 hours half-life at 25°C) (Note 1)		
	Display Size	219.6 x 131.76mm	211.2 x 158.4mm	211.2 x 158.4mm
Operation System		Delta Real Time OS		
MCU		32-bit RISC Micro-controller		
Flash ROM		Flash ROM 128 MB (OS System: 30MB / Backup: 16MB / User Application: 82MB)		
SDRAM		64Mbytes		
Backup Memory		32Kbytes		
Audio Output	Buzzer	Multi-Tone Frequency (2K ~ 4K Hz) / 85dB		
	AUX	N/A		Stereo Output
Ethernet Interface		N/A		IEEE 802.3, IEEE 802.3u 10/100 Mbps auto-sensing (has built-in isolated power circuit) (Note 3)
Memory Card		N/A		SD Card (supports SDHC)
USB		1 USB Slave Ver 2.0 1 USB Host (Note 2) Ver 1.1		
Serial COM Port	COM1	RS-232 (supports hardware flow control)		
	COM2	RS-232/485	RS-232/485	RS-232/422/485 (has built-in isolated power circuit) (Note 3)
	COM3	RS-232/422/485	RS-232/422/485	RS-232/422/485 (has built-in isolated power circuit) (Note 3)
Perpetual Calendar (RTC)		Built-in		
Cooling Method		Natural air circulation		
Safety Approval		UL (Note 4) / CE (Note 4)		
Waterproof Degree		IP65		
Operation Voltage (Note 3)		DC +24V (-10% ~ +15%)		
Voltage Endurance		AC500V for 1 minute (between charging (DC24V terminal) and FG terminals)		
Power Consumption (Note 3)		6.6W	6.1W	9.6W
Backup Battery		3V lithium battery CR2032 x 1		
Backup Battery Life		It depends on the temperature used and the conditions of usage, about 3 years or more at 25°C.		
Operation Temperature		0°C ~ 50°C		
Storage Temperature		-20°C ~ +60°C		
Ambient Humidity		10% ~ 90% RH [0 ~ 40°C], 10% ~ 55% RH [41 ~ 50°C] Pollution Degree 2		
Vibration		IEC 61131-2 compliant 5Hz ≤ f < 8.3Hz = Continuous: 3.5mm, 8.3Hz ≤ f ≤ 150Hz = Continuous: 1.0g		
Shock		IEC 60068-2-27 compliant 15g peak for 11 ms duration, X, Y, Z directions for 6 times		
Dimensions (W) x (H) x (D) mm		272 x 200 x 61	299 x 224 x 46.8	299 x 224 x 46.8
Panel Cutout (W) x (H) mm		261.3 X 189.3	285.2 x 210.2	285.2 x 210.2
Weight		Approx. 1520g	Approx. 1735g	Approx. 1600g

NOTE

- 1) The half-life of backlight is defined as original luminance being reduced by 50% when the maximum driving current is supplied to HMI. The life of LED backlight shown here is an estimated value under 25 °C normal temperature and humidity conditions.
- 2) USB Host port can provide up to 5V/ 100mA of power.
- 3) The value of the power consumption indicates the electrical power consumed by HMI only without connecting to any peripheral devices. In order to ensure the normal operation, it is recommended to use a power supply which the capacity is 1.5 ~2 times the value of the power consumption.
- 4) Some models are in the process of application to UL and KCC certification. For more information, please consult our distributors.
- 5) The content of this instruction sheet may be revised without prior notice. Please consult our distributors or download the most updated version at <http://www.delta.com.tw/ia>.

Bilgi Dokümanı

(1) Önsöz

DELTA'nın DOP-B serisi operatör panellerini seçtiğiniz için teşekkürler. Bu bilgi dokümanı Delta HMI kurulum, bağlantı, bakım ve kontrolünde kullanıcıya yardımcı olacaktır. Doğru kullanım için ürünü kullanmadan önce bu dokümanı mutlaka okuyunuz. Kurulum, bağlantı ve çalışma yapmadan önce güvenlik uyarılarını tamamen anladığınızdan emin olunuz. Bu dokümanı daha sonra da kullanmak için iyi muhafaza ediniz. Lütfen aşağıdaki güvenlik uyarılarına dikkat ediniz:

- Ürünün kurulumunu yanıcı gaz ve sıvılardan uzak, kuru ve temiz ortamlara yapınız.
- Bağlantıları yaparken tüm bağlantı kurallarının sağlandığından emin olunuz.
- HMI'nin toprak bağlantısının doğru yapıldığından emin olunuz. Topraklama metodunun ürünün kurulduğu ülke standartlarına uygun olduğuna emin olunuz (NFPA 70: National Electrical Code, 2005 Ed.).
- HMI enerjili iken kablo bağlantısı yapmayınız ya da sökmeyiniz.
- Çalışma sırasında enerji besleme terminallerine dokunmayınız. Aksi halde elektrik şoku olabilir.

Ürünün kullanımı ile ilgili sorularınız için, lütfen teknik servisimize bağlantıya geçiniz.

Herhangi bir ihbara gerek kalmaksızın bu bilgi dokümanının içeriği değiştirilebilir. Güncellenmiş versiyonu elde etmek için teknik servise danışılabilir veya internet adresinden indirebilirsiniz.

(2) Seri Haberleşme Pin Açıklamaları

DOP-B10S411 / DOP-B10S511/ DOP-B10E515 COM1 Port

COM Port	PIN	MOD 1
	1	RS-232
	2	RXD
	3	TXD
	4	
	5	GND
	6	
	7	RTS
	8	CTS
	9	

Not1: Boş = Bağlantı Yapılmaz.

DOP-B10S411 / DOP-B10S511 COM2 Port

COM Port	PIN	MOD 1		MOD 2		MOD 3	
		COM2	COM3	COM2	COM3	COM2	COM3
	1	RS-232	RS-232	RS-485	RS-485	-	RS-422
	2	RXD		D+			TXD+
	3	TXD					
	4				D+		RXD+
	5	GND		GND		GND	
	6			D-			TXD-
	7		TXD				
	8		RXD				
	9				D-		RXD-

Not1: Boş = Bağlantı Yapılmaz.

Not2: DOP-B10S411 / DOP-B10S511 serisi modeller RS-422 akış kontrol desteklemez.

DOP-B10E515 COM2 Port

COM Port	PIN	MOD 1	MOD 2	MOD 3
	1	RS-232	RS-422	RS-485
	2	RXD	TXD+	D+
	3	TXD		
	4		RXD+	
	5	GND	GND	GND
	6		TXD-	D-
	7	RTS		
	8	CTS		
	9		RXD-	

Not1: Boş = Bağlantı Yapılmaz.

Not2: COM2 portu RS-232 akış denetimi(flow control) için kullanıldığında (RTS, CTS set edilir), COM3 portu kullanılmaz.

Not3: COM2 portu RS-422 akış denetimi(flow control) için kullanıldığında ihtiyaç duyulan pin ayarları için DOP-B10E515 COM3 port tablosu içerisindeki MOD 2 pin açıklamalarına bakınız.

DOP-B10E515 COM3 Port

COM Port	PIN	MOD 1	MOD 2	MOD 3
	1	RS-232	RS-422	RS-485
	2	RXD	TXD+(RTS+)	D+
	3	TXD		
	4		RXD+(CTS+)	
	5	GND	GND	GND
	6		TXD-(RTS-)	D-
	7			
	8			
	9		RXD-(CTS-)	

Not1: Boş = Bağlantı Yapılmaz.

Not2: COM2 portu RS-422 akış denetimi(flow control) için kullanıldığında ihtiyaç duyulan pin ayarları için DOP-B10E515 COM3 port tablosu içerisindeki MOD 2 pin açıklamalarına bakınız.

(3) Parça İsimleri

DOP-B10S411 (Ön Görünüm)

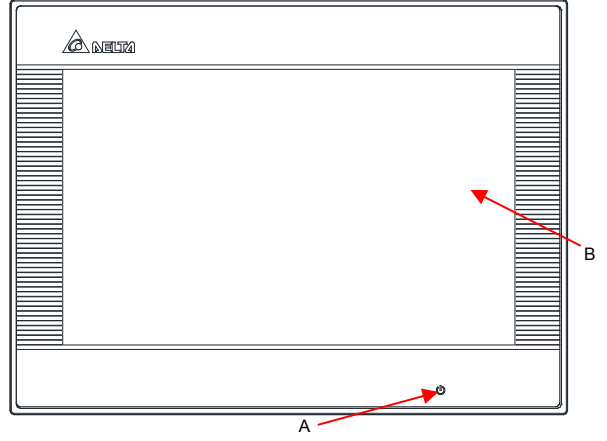

A	Power LED Göstergesi ()	Not: () HMI normal çalışınca Yeşil yanar.
B	Dokunmatik Ekran / Display	

DOP-B10S411 (Arka Görünüm)

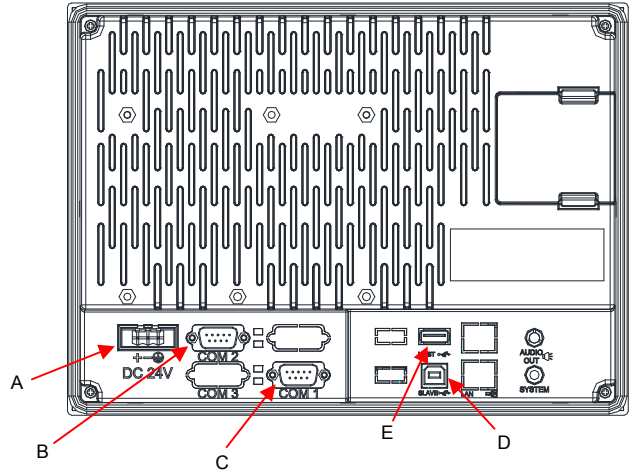

A	Power Giriş Terminali	D	USB Slave
B	COM2	E	USB Host
C	COM1	Lütfen dikkat DOP-B10S411 modeli, sistem tuşuna sahip değildir. Kullanıcı, ekrandaki boş bir alana bir süre basılı tuttuğunda bir Buzzer sesi duyacaktır. Buzzer sesini duyduktan sonra sistem menüsüne erişmek için lütfen ekranın sol üst köşesine 4~5sn basılı tutun.	

DOP-B10S511 / DOP-B10E515 (Ön Görünüm)

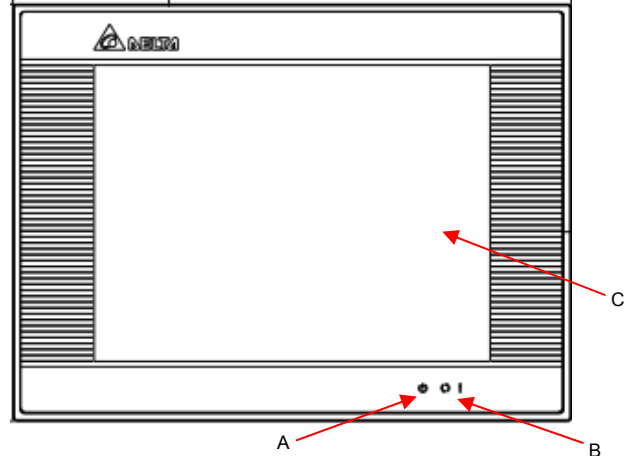

A	Power LED Göstergesi ()	() HMI normal olarak çalışırken ışık Yeşil yanar.
B		

B	Çalışma LED Göstergesi () / Alarm LED Göstergesi (!)	• Haberleşme gerçekleştiriliyor / Verilere erişiliyor iken Mavi yanar. (Açıklama için "Not" bölümüne bakınız). ! Alarmlardan herhangi biri ON iken Kırmızı yanar.
C	Dokunmatik Ekran / Display	Not: Çalışma LED göstergesi (Mavi) tanımlaması serbest olarak kullanıcı tarafından ayarlanabilir.

DOP-B10S511 modelinde sadece Power LED Göstergesi (A) ve Dokunmatik Ekran / Display (C) mevcut olduğuna lütfen dikkat ediniz.

DOP-B10S511 / DOP-B10E515 (Arka Görünüm)

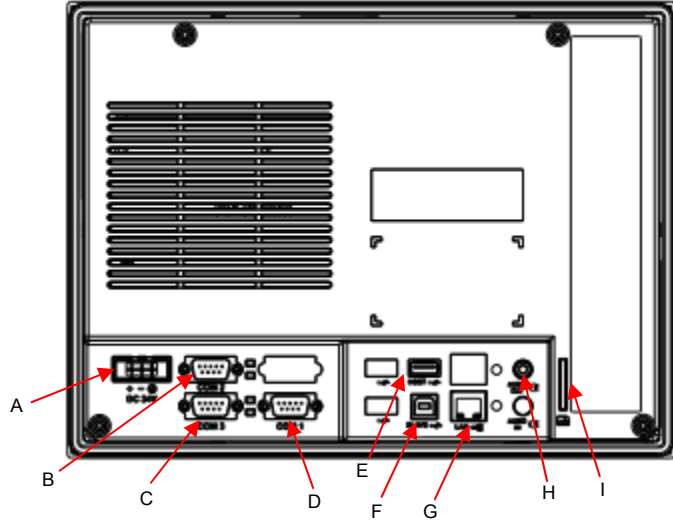

A	Power Giriş Terminali	F	USB Slave
B	COM2 (HMI'nin haberleşme sırasında okuma ve yazma durumunu gösterir iki adet LED gösterge vardır.) COM3 (HMI'nin haberleşme sırasında okuma ve yazma durumunu gösterir iki adet LED gösterge vardır.) Not: Sadece DOP-B10E515.	G	Ethernet Arabirimi (LAN) Not: Sadece DOP-B10E515.
C	COM2 (HMI'nin haberleşme sırasında okuma ve yazma durumunu gösterir iki adet LED gösterge vardır.) Not: Sadece DOP-B10E515.	H	Audio Çıkış Arabirimi Not: Sadece DOP-B10E515.
D	COM1	I	Memory Kart Slotu Not: Sadece DOP-B10E515.
E	USB Host	Lütfen dikkat DOP-B10S511 / DOP-B10E515 modeli, sistem tuşuna sahip değildir. Kullanıcı, ekrandaki boş bir alana bir süre basılı tuttuğunda bir Buzzer sesi duyacaktır. Buzzer sesini duyduktan sonra sistem menüsüne erişmek için lütfen ekranın sol üst köşesine 4~5sn basılı tutun.	

(4) Ölçüler

DOP-B10S411

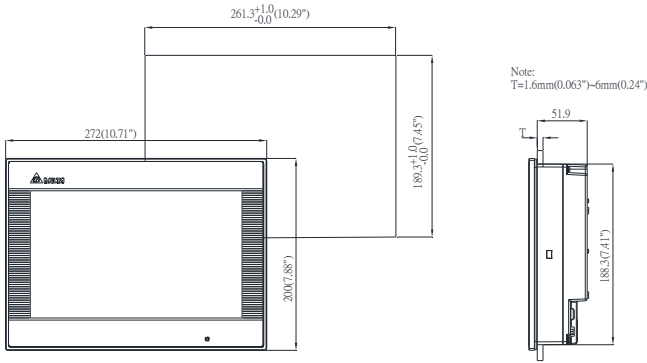

DOP-B10S511 / DOP-B10E515

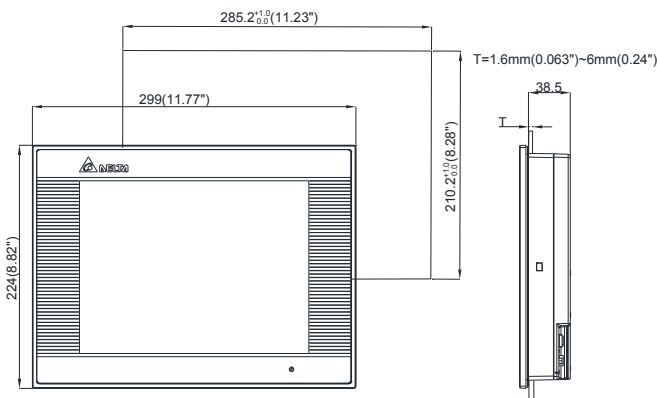

(5) Özellikler

Model Adı	DOP-B10S411	DOP-B10S511	DOP-B10E515	
LCD MODULE	Display Tipi	10.1" Geniş Ekran TFT LCD (65536 renk)	10.4" TFT LCD (65536 renk)	10.4" TFT LCD (65536 renk)
	Çözünürlük	800 x 480 pixel	800 x 600 pixel	800 x 600 pixel
	Aydınlatma	LED Aydınlatma (25°C yarım ömürde 20,000 saatten az) ^(Not 1)		
	Display Ölçü	219.6 x 131.76mm	211.2 x 158.4mm	211.2 x 158.4mm
İşletim Sistemi	Delta Real Time OS			
MCU	32-bit RISC Mikro-işlemci			
Flash ROM	Flash ROM 128 MB (OS Sistem: 30MB / Backup: 16MB / Kullanıcı Uygulama: 82MB)			
SDRAM	64Mbyte			
Backup Memory	32Kbyte			
Audio Çıkışı	Buzzer	Multi-Tone Frekans (2K ~ 4K Hz) / 85dB		
	AUX	N/A	Stereo Çıkış	
Ethernet Arabirimi	N/A		IEEE 802.3, IEEE 802.3u	
	N/A		10/100 Mbps otomatik algılamalı (dahili izoleli güç devresi mevcut ^(Not 3))	
Memory Kart	N/A		SD Kart (SDHC destekler)	
USB	1 USB Slave Ver 2.0 1 USB Host ^(Note 2) Ver 1.1			
	COM1	RS-232 (donanım akış denetimi(flow control) destekler)		
Seri COM Port	COM2	RS-232/485	RS-232/485	RS-232/422/485 (dahili izoleli güç devresi mevcut ^(Not 3))
	COM3	RS-232/422/485	RS-232/422/485	RS-232/422/485 (dahili izoleli güç devresi mevcut ^(Not 3))
	Gerçek Zaman Saati (RTC)			Dahili
Soğutma Metodu	Doğal Hava Sirkülasyonu			
Güvenlik Onayı	UL ^(Not 4) / CE ^(Not 4)			
Su Geçirmezlik Derecesi	IP65			
Çalışma Voltajı ^(Not 3)	DC +24V (-10% ~ +15%)			
Dayanma Voltajı	1 dakika için AC500V (DC24V besleme terminalleri ve FG terminalleri arasında)			
Güç Tüketimi ^(Not 3)	6.6W	6.1W	9.6W	
Backup Pili	3V lityum pil CR2032 x 1			
Backup Pili Ömrü	Kullanım koşulları ve ortam sıcaklığına bağlı olarak 25°C'de yaklaşık 3 yıl veya üzeri.			
Çalışma Sıcaklığı	0°C ~ 50°C			
Saklama Sıcaklığı	-20°C ~ +60°C			
Rutubet Oranı	10% ~ 90% RH [0 ~ 40°C], 10% ~ 55% RH [41 ~ 50°C] Kirlenme Derecesi 2			
Titreşim	IEC 61131-2 uyumlu 5Hz ≤ f < 8.3Hz = Sürekli: 3.5mm, 8.3Hz ≤ f ≤ 150Hz = Sürekli: 1.0g			
Şok	IEC 60068-2-27 uyumlu 11ms süresince 15g pik, X, Y, Z yönünde 6 defa			
Ölçüler (W) x (H) x (D) mm	272 x 200 x 61	299 x 224 x 46.8	299 x 224 x 46.8	
Panel Kesim Ölçüsü (W) x (H) mm	261.3 X 189.3	285.2 x 210.2	285.2 x 210.2	
Ağırlık	Yaklaşık 1520g	Yaklaşık 1735g	Yaklaşık 1600g	

NOTE

- 1) Arka ışık yarı-ömürü, HMI maksimum akımla beslendiğinde orijinal aydınlatmanın %50 düşürüldüğü anlamına gelir. Yukarıda gösterilen arka ışık LED aydınlatma ömrü 25°C derecede normal sıcaklık ve rutubet ortamında tahmin edilen değerlerdir.
- 2) USB Host port 5V/ 100mA'e kadar güç sağlar.
- 3) Güç tüketimi HMI ünitesinin hiç bir cihaza bağlı olmadan boş olarak tükettiği gücü gösterir. Normal çalışmada HMI'nin boş iken tükettiği gücün 1.5 veya 2 katı güç verebilen besleme kaynağı kullanılması tavsiye edilir.
- 4) Bazı modeller UL ve KCC sertifikaya başvuru süreci içerisindedir. Daha fazla bilgi için firmamızla temasa geçiniz.
- 5) Herhangi bir ihbar olmadan bu dokümanın içeriği değiştirilebilir. En son güncellenmiş halini firmamızdan talep edebilir yada aşağıdaki link adresinden indirebilirsiniz <http://www.delta.com.tw/ia>.

TÜRKİYE İTHALATÇI FIRMA
FABRİKA AYGITLARI SİSTEM TEKNOLOJİSİ BİLGİSAYAR YAZILIM VE ELEKTRONİK PAZARLAMA İTHALAT İHRACAT ANONİM ŞİRKETİ
FAST Plaza Küçükçekirli Köyü Mh. Dereyolu Sk. No:4
ATAŞEHİR / İSTANBUL
T: +90 216 574 94 34 F: +90 216 574 16 60
E: satis@fasttld.net W: www.fasttld.net

Üretici Firma
Delta Electronics, Inc.
Taiwan
31-1 Xinggang Road,
Guishan Industrial Zone,
Taoyuan County 33370,
Taiwan
TEL: 886-3-362-5301
FAX: 886-3-362-7267
China
1688 Jiangxing East Road,
Wujiang Economic Development Zone
Wujiang City, Jiang Su Province,
People's Republic of China (Post code: 215200)
TEL: 86-512-6340-3008
FAX: 86-769-6340-7280

DOP-B10

高彩·寬螢幕·友好機介面
No.18, Xinglong Rd., Taoyuan City 33068, Taiwan

安裝說明

(1) 一般注意事項

感謝您使用本產品。本人機介面安裝說明書提供 DOP-B 系列人機介面的相關資訊。在使用之前，請您仔細詳讀本說明書以確保使用上的正確。此外，請妥善將其放置在明顯的地點以便隨時查閱。下列事項在您尚未讀完本說明書前，請務必遵守：

- 安裝的環境必須沒有水氣、腐蝕性氣體及可燃性氣體。
- 接線時，請依接線圖說明施工。
- 接地工程必須確實實施，接地時須遵照國家現行相關電工法規之規定施行 (請參考 NFPA 70: National Electrical Code, 2005 Ed.)。
- 在通電時，請勿拆解人機介面或更改配線。
- 在通電運作時，請勿接觸電源處，以免觸電。

如果您在使用上仍有問題，請洽詢經銷商或者本公司客服中心。由於產品精益求精，當內容規格有所修正時，請洽詢代理商或至台達網站 (<http://www.delta.com.tw/ia>) 下載最新版本。

(2) 通訊腳位定義

DOP-B10S411 / DOP-B10S511 / DOP-B10E515 COM1 定義

COM Port 示意圖	腳位	MODE1
		RS-232
	1	
	2	RXD
	3	TXD
	4	
	5	GND
	6	
	7	RTS
	8	CTS
	9	

註：空白 = 請勿接線，避免造成誤動作

DOP-B10S411 / DOP-B10S511 COM2 定義

COM Port 示意圖	腳位	MODE1		MODE2		MODE3	
		COM2	COM3	COM2	COM3	COM2	COM3
		RS-232	RS-232	RS-485	RS-485	-	RS-422
	1			D+			TXD+
	2	RXD					
	3	TXD					
	4				D+		RXD+
	5	GND		GND			GND
	6			D-			TXD-
	7		TXD				
	8		RXD				
	9			D-			RXD-

註：空白 = 請勿接線，避免造成誤動作

註：機種不支援 RS422 流量控制

DOP-B10E515 COM2 定義

COM Port 示意圖	腳位	MODE1	MODE2	MODE3
		RS-232	RS-422	RS-485
	1		TXD+	D+
	2	RXD		
	3	TXD		
	4		RXD+	
	5	GND	GND	GND
	6		TXD-	D-
	7	RTS		
	8	CTS		
	9		RXD-	

註 1：空白 = 請勿接線，避免造成誤動作

註 2：當 COM2 使用 RS-232 流量控制(RTS、CTS 腳位)時，COM3 則無法使用。

註 3：當 COM2 使用 RS-422 流量控制時，其流量控制腳位請參考 COM3 MODE2 括號內的腳位定義。

DOP-B10E515 COM3 定義

COM Port 示意圖	腳位	MODE1	MODE2	MODE3
		RS-232	RS-422	RS-485
	1		TXD+(RTS+)	D+
	2	RXD		
	3	TXD		
	4		RXD+(CTS+)	
	5	GND	GND	GND
	6		TXD-(RTS-)	D-
	7			
	8			
	9		RXD-(CTS-)	

註 1：空白 = 請勿接線，避免造成誤動作

註 2：當 COM2 使用 RS-422 流量控制時，其流量控制腳位請參考 MODE2 括號內的腳位定義。

(3) 各部位說明

DOP-B10S411(正面)

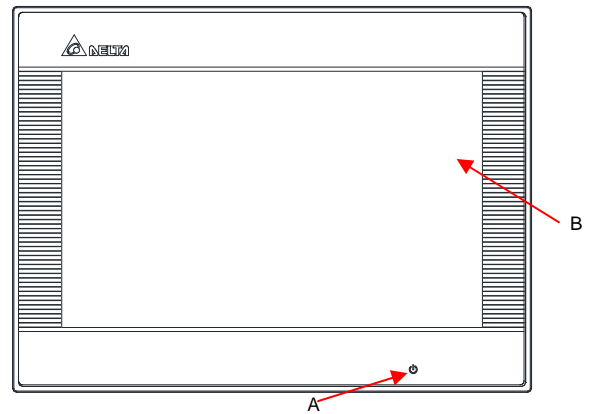

A	電源指示燈 ()	註： 綠燈亮：正常運作
B	操作/顯示區域	

DOP-B10S411 (背面)

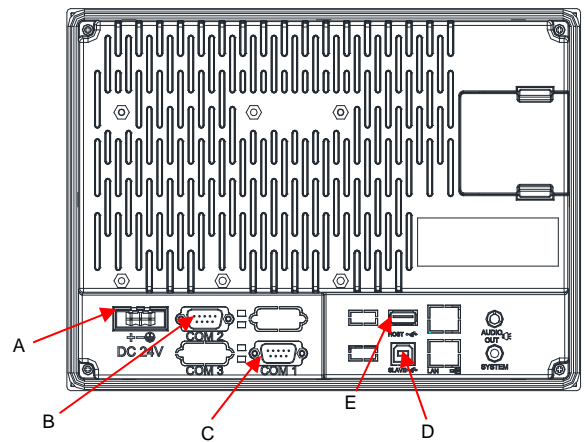

A	電源輸入端子	D	USB Slave
B	COM2	E	USB Host
C	COM1	註：DOP-B10S411 無系統鍵，請於畫面上空白處長按 3 秒，待聽到嗶聲後，按下左上角，即可進入系統畫面	

DOP-B10S511 / DOP-B10E515 (正面)

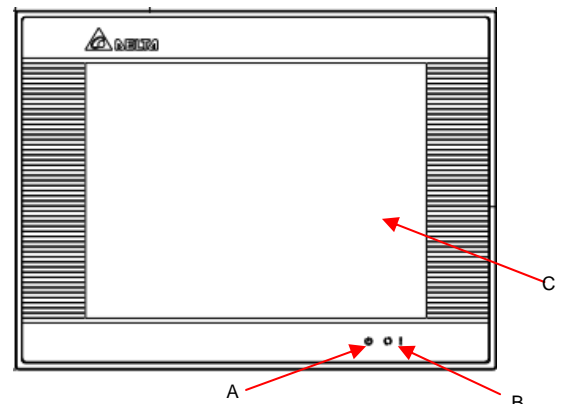

A	電源指示燈 ()	綠燈亮：正常運作
B	動作指示燈 () / 警報指示燈 (!)	藍燈閃爍：通訊中 / 資料存取中 (註) 紅燈閃爍：警報發生中
C	操作/顯示區域	註：藍色燈號顯示定義可由使用者自行設定

註：DOP-B10S511 只有電源指示燈(A)與操作/顯示區域(C)

DOP-B10S511 / DOP-B10E515 (背面)

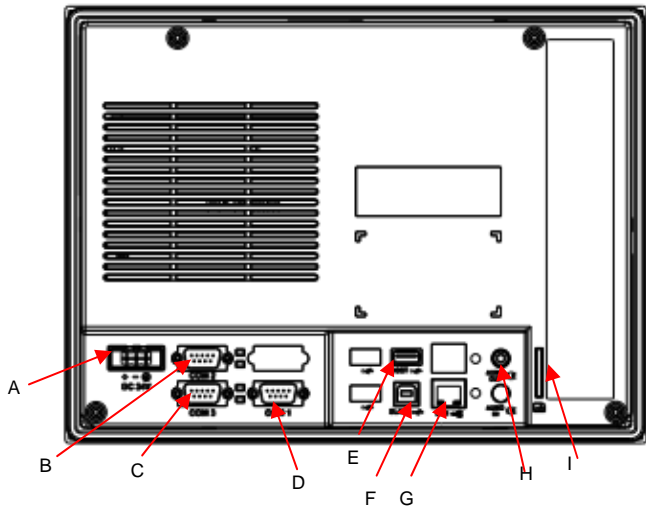

A	電源輸入端子	F	USB Slave
B	COM2 (支援通訊狀態指示燈號)	G	網路埠 (LAN) 註：只針對 DOP-B10E515
C	COM3 (支援通訊狀態指示燈號) 註：只針對 DOP-B10E515	H	音效輸出埠 註：只針對 DOP-B10E515
D	COM1	I	記憶卡插槽 註：只針對 DOP-B10E515
E	USB Host	註：DOP-B10S511 / DOP-B10E515 無系統鍵，請於畫面上空白處長按 3 秒，待聽到嗶聲後，按下左上角，即可進入系統畫面	

(4) 開孔尺寸

DOP-B10S411

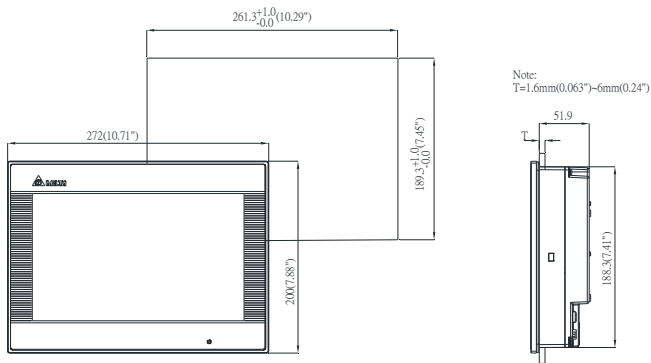

DOP-B10S511 / DOP-B10E515

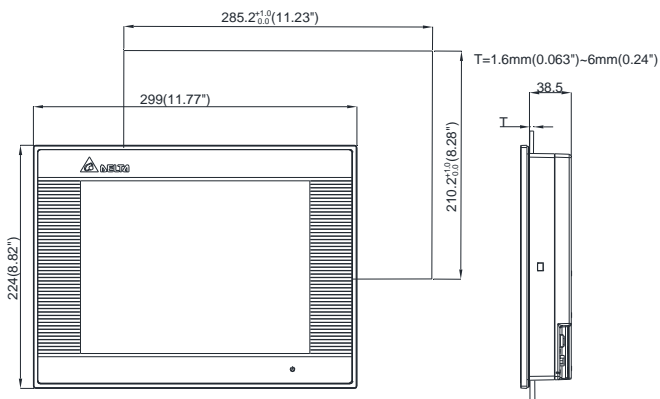

(5) 硬體規格

型號	DOP-B10S411	DOP-B10S511	DOP-B10E515	
顯示器	面板種類	10.1" 寬螢幕 TFT LCD (65536 色)	10.4" TFT LCD (65536 色)	10.4" TFT LCD (65536 色)
	解析度	800 x 480 pixels	800 x 600 pixels	800 x 600 pixels
	背光燈	LED Back Light (常溫 25°C 下半衰期 > 2 萬小時) (Note 1)		
	顯示範圍	219.6 x 131.76mm	211.2 x 158.4mm	211.2 x 158.4mm
作業系統	Delta Real Time OS			
中央處理器	32-bit RISC Micro-controller			
記憶體 ROM	Flash ROM 128 MB(OS System: 30MB / Backup: 16MB / User Application: 82MB)			
內部記憶體	64Mbytes			
斷電保持記憶體	16Mbytes			
音效輸出	蜂鳴器	Multi-Tone Frequency (2K ~ 4K Hz) / 85dB		
	AUX	N/A	Stereo output	
網路介面	N/A	IEEE 802.3, IEEE 802.3u		
		10/100 Mbps 自動偵測 (內建隔離電路) (Note 3)		
記憶卡	N/A	SD 卡(支援 SDHC)		
USB	1 USB Slave Ver 2.0 1 USB Host (Note 2) Ver 1.1			
串列通訊埠	COM1	RS-232 (支援流量控制)		
	COM2	RS-232/485	RS-232/485 / RS-485 (內建隔離電路) (Note 3)	
	COM3	RS-232/422/485	RS-232 / RS-422 / RS-485 (內建隔離電路) (Note 3)	
萬年曆	內建			
冷卻方式	自然冷卻			
安規認證	UL (Note 4) / CE (Note 4)			
面板防水等級	IP65			
工作電壓 (Note 3)	DC +24V (-10% ~ +15%)			
絕緣耐力	DC24V 端子與 FG 端子間：AC500V, 1 分鐘			
消耗功率 (Note 3)	6.6W	6.1W	9.6W	
記憶體備份電池	3V 鋰電池 CR2032			
備份電池壽命	依使用環境溫度及使用條件而不同，常溫 25°C 下壽命約五年以上			
操作溫度	0°C ~ 50°C			
儲存溫度	-20°C ~ +60°C			
工作環境	10% ~ 90% RH [0 ~ 40°C] · 10% ~ 55% RH [41 ~ 50°C] · 污染等級 2			
耐震動	IEC61131-2 規定連續震動 5Hz~8.3Hz 3.5mm, 8.3Hz~150Hz 1G			
耐衝擊	IEC60068-2-27 規定耐衝擊 11ms, 15G Peak, X, Y, Z 方向各 6 次			
尺寸 (W)x(H)x(D) mm	272 x 200 x 61	299 x 224 x 46.8	299 x 224 x 46.8	
開孔尺寸 (W) x (H) mm	261.3 X 189.3	285.2 x 210.2	285.2 x 210.2	
重量	約 1520g	約 1735g	約 1600g	

NOTE

- 1) 背光模組半衰期的定義：最大驅動電流下，背光亮度衰退到最大亮度的一半時，即為半衰期。所標示之壽命時間為 25°C 常溫常濕工作環境下之預估值。
- 2) USB Host 最大可提供 5V/ 100mA 電源。
- 3) 消耗功率為無外接週邊設備時，人機本體所消耗的功率。建議選用的電源供應器容量為標示消耗功率之 1.5~2 倍，以確保人機工作正常。
- 4) 部份機種認證申請中，詳細認證機種請洽詢各區域代理商。
- 5) 本人機介面安裝手冊內所記載之規格若有變更，本公司恕不另行通知。當內容規格有所修正時，請洽詢代理商或至台達網站 <http://www.delta.com.tw/ia>。



高彩·宽屏幕·友好人机界面
No.18, Xinglong Rd., Taoyuan City
33068, Taiwan

DOP-B10

安装说明

(1) 一般注意事项

感谢您使用本产品，本人机界面安装说明书提供 DOP-B 系列人机界面的相关资讯。在使用之前，请您仔细阅读本说明书以确保使用上的正确。此外，请妥善将其放置在明显的地点以便随时查阅。下列事项在您尚未读完本说明书前，请务必遵守：

- 安装的环境必须没有水气、腐蚀性气体及可燃性气体。
- 接线时，请依接线图说明施工。
- 接地工程必须确实实施，接地时须遵照国家现行相关电工法规的规定施行（请参考 NFPA 70: National Electrical Code, 2005 Ed.）。
- 在通电时，请勿拆解人机界面或更改配线。
- 在通电运作时，请勿接触电源处，以免触电。

如果您在使用上仍有问题，请咨询经销商或者本公司客服中心。由于产品精益求精，当内容规格有所修正时，请咨询代理商或至台达网站 (<http://www.delta.com.tw/ia>) 下载最新版本。

(2) 通讯脚位定义

DOP-B10S411 / DOP-B10S511/DOP-B10E515 COM1 定义

COM Port 示意图	脚位	MODE1 RS-232
	1	
	2	RXD
	3	TXD
	4	
	5	GND
	6	
	7	RTS
	8	CTS
	9	

注：空白 = 请勿接线，避免造成误动作

DOP-B10S411 / DOP-B10S511 COM2 定义

COM Port 示意图	脚位	MODE1		MODE2		MODE3	
		COM2	COM3	COM2	COM3	COM2	COM3
		RS-232	RS-232	RS-485	RS-485	-	RS-422
	1			D+			TXD+
	2	RXD					
	3	TXD					
	4				D+		RXD+
	5	GND		GND		GND	
	6			D-			TXD-
	7		TXD				
	8		RXD				
	9			D-			RXD-

注：空白 = 请勿接线，避免造成误动作

注：机种不支持 RS422 流量控制

DOP-B10E515 COM2 定义

COM Port 示意图	脚位	MODE1	MODE2	MODE3
		RS-232	RS-422	RS-485
	1		TXD+	D+
	2	RXD		
	3	TXD		
	4		RXD+	
	5	GND	GND	GND
	6		TXD-	D-
	7	RTS		
	8	CTS		
	9		RXD-	

注 1：空白 = 请勿接线，避免造成误动作

注 2：当 COM2 使用 RS-232 流量控制(RTS、CTS 脚位)时，COM3 则无法使用。

注 3：当 COM2 使用 RS-422 流量控制时，其流量控制脚位请参考 COM3 MODE2 括号内的脚位定义。

DOP-B10E515 COM3 定义

COM3 定义

COM Port 示意图	脚位	MODE1 RS-232	MODE2 RS-422	MODE3 RS-485
	1		TXD+(RTS+)	D+
	2	RXD		
	3	TXD		
	4		RXD+(CTS+)	
	5	GND	GND	GND
	6		TXD-(RTS-)	D-
	7			
	8			
	9		RXD-(CTS-)	

注 1：空白 = 请勿接线，避免造成误动作

注 2：当 COM2 使用 RS-422 流量控制时，其流量控制脚位请参考 MODE2 括号内的脚位定义。

(3) 各部位说明

DOP-B10S411(正面)

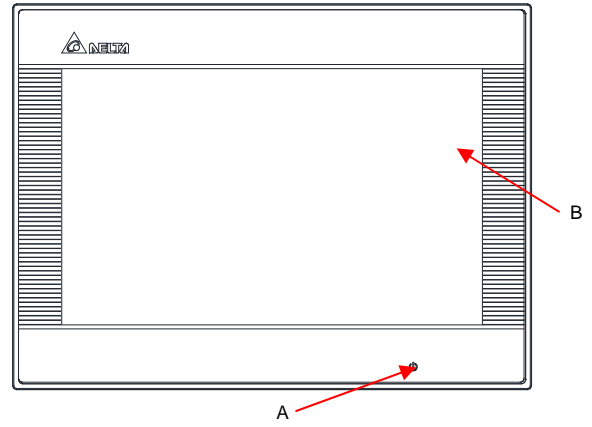

A	电源指示灯 ()	注： 绿灯亮：正常运作
B	操作/显示区域	

DOP-B10S411 (背面)

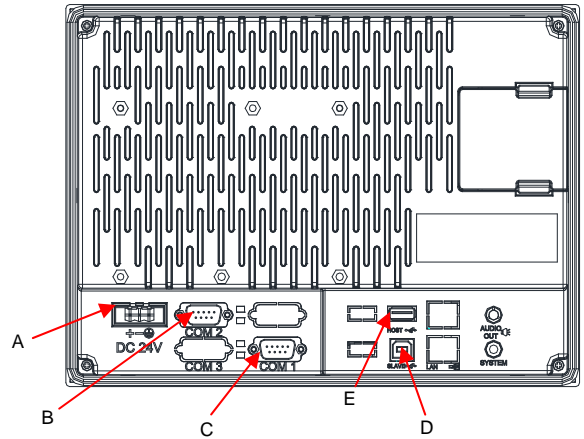

A	电源输入端子	D	USB Slave
B	COM2	E	USB Host
C	COM1	注：DOP-B10S411 无系统键，请于画面上空白处长按 3 秒，待聽到嗶聲後按下左上角，即可进入系统画面	

DOP-B10S511 / DOP-B10E515 (正面)

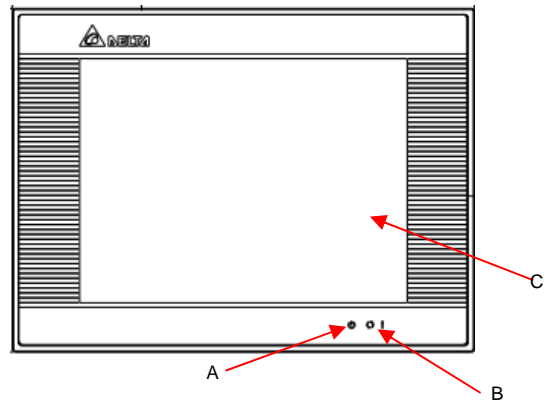

A	电源指示灯 ()	绿灯亮：正常运作
B	动作指示灯 () / 警报指示灯 ()	蓝灯闪烁：通讯中 / 数据存取中 (注)
		红灯闪烁：警报发生中
C	操作/显示区域	注：蓝色灯号显示定义可由使用者自行设定

注：DOP-B10S511 只有电源指示灯(A)与操作/显示区域(C)

DOP-B10S511 / DOP-B10E515 (背面)

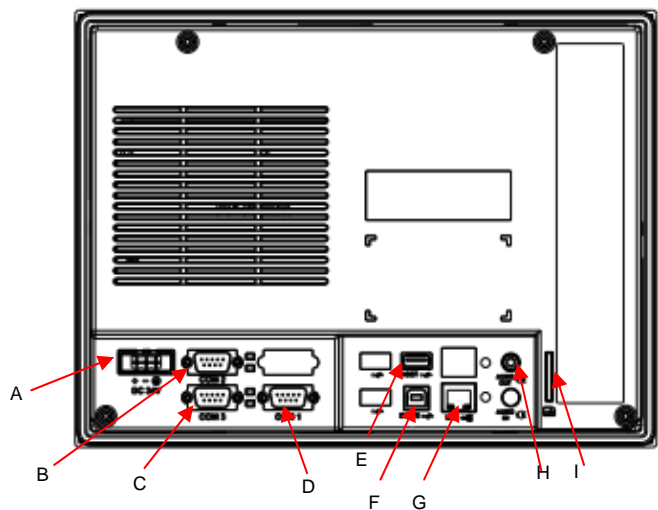

A	电源输入端子	F	USB Slave
B	COM2 (支持通讯状态指示灯)	G	网络口 (LAN) 注: 只针对 DOP-B10E515
C	COM3 (支持通讯状态指示灯) 注: 只针对 DOP-B10E515	H	音效输出口 注: 只针对 DOP-B10E515
D	COM1	I	存储卡插槽 注: 只针对 DOP-B10E515
E	USB Host	注: DOP-B10S511 / DOP-B10E515 无系统键, 请于画面上空白处长按 3 秒, 待听到嗶聲後按下左上角, 即可进入系统画面	

(4) 开孔尺寸

DOP-B10S411

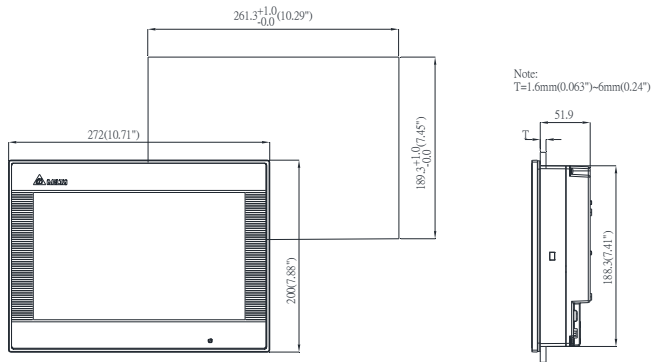

DOP-B10S511 / DOP-B10E515

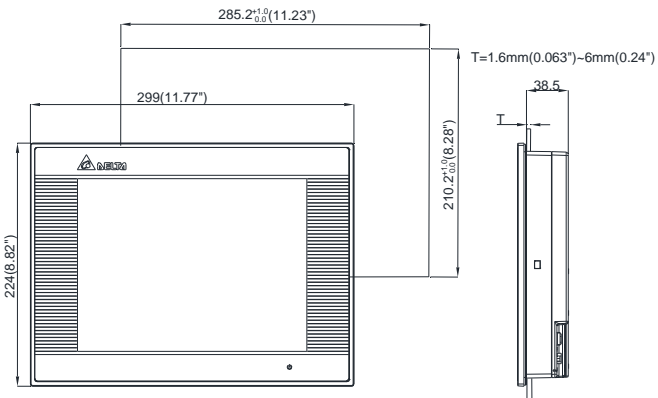

(5) 硬件规格

型号		DOP-B10S411	DOP-B10S511	DOP-B10E515
显示	面板种类	10.1" 宽屏幕 TFT LCD (65536 色)	10.4" TFT LCD (65536 色)	10.4" TFT LCD (65536 色)
	解析度	800 x 480 pixels	800 x 600 pixels	800 x 600 pixels
	背光灯	LED Back Light (常温 25°C 下半衰期>2 万小时) (Note 1)		
	显示范围	219.6 x 131.76mm	211.2 x 158.4mm	211.2 x 158.4mm
作业系统		Delta Real Time OS		
中央处理器		32-bit RISC Micro-controller		
存储器 ROM		Flash ROM 128 MB(OS System: 30MB / Backup: 16MB / User Application: 82MB)		
内部存储器		64Mbytes		
断电保持存储器		16Mbytes		
音效输出	蜂鸣器	Multi-Tone Frequency (2K ~ 4K Hz) / 85dB		
	AUX	N/A	Stereo output	
网络界面		N/A	IEEE 802.3, IEEE 802.3u 10/100 Mbps 自动侦测 (内建屏蔽电路 (Note 3))	
存储卡		N/A	SD 卡(支持 SDHC)	
USB		1 USB Slave Ver 2.0 1 USB Host (Note 2) Ver 1.1		
串行通讯口	COM1	RS-232 (支持流量控制)		
	COM2	RS-232/485	RS-232/485	RS-232 / RS-422 / RS-485 (内建屏蔽电路 (Note 3))
	COM3	RS-232/422/485	RS-232/422/485	RS-232 / RS-422 / RS-485 (内建屏蔽电路 (Note 3))
万年历		内建		
冷却方式		自然冷却		
安规认证		UL (Note 4) / CE (Note 4)		
面板防水等级		IP65		
工作电压 (Note 3)		DC +24V (-10% ~ +15%)		
绝缘耐力		DC24V 端子与 FG 端子间: AC500V, 1 分钟		
消耗功率 (Note 3)		6.6W	6.1W	9.6W
存储器备份电池		3V 锂电池 CR2032		
备份电池寿命		依使用环境温度及使用条件而不同, 常温 25°C 下寿命约五年以上		
操作温度		0°C ~ 50°C		
储存温度		-20°C ~ +60°C		
工作环境		10% ~ 90% RH [0 ~ 40°C] · 10% ~ 55% RH [41 ~ 50°C] · 污染等级 2		
耐震动		IEC61131-2 规定连续震动 5Hz~8.3Hz 3.5mm, 8.3Hz~150Hz 1G		
耐冲击		IEC60068-2-27 规定耐冲击 11ms, 15G Peak, X, Y, Z 方向各 6 次		
尺寸 (W)x(H)x(D) mm		272 x 200 x 61	299 x 224 x 46.8	299 x 224 x 46.8
开孔尺寸 (W) x (H) mm		261.3 X 189.3	285.2 x 210.2	285.2 x 210.2
重量		约 1520g	约 1735g	约 1600g

NOTE

- 1) 背光模组半衰期的定义: 最大驱动电流下, 背光亮度衰退到最大亮度的一半时, 即为半衰期。所标示的寿命时间为 25°C 常温常湿工作环境下的预估值。
- 2) USB Host 最大可提供 5V/ 100mA 电源。
- 3) 消耗功率为无外接周边设备时, 人机本体所消耗的功率。建议选用的电源供应器容量为标示消耗功率的 1.5~2 倍, 以确保人机工作正常。
- 4) 部份機種认证申请中, 详细认证機種请咨询各区域代理商。
- 5) 本人机界面安装手册内所记载的规格若有变更, 本公司恕不另行通知。当内容规格有所修正时, 请咨询代理商或至台达网站 <http://www.delta.com.tw/ia>。