

Derwent
Top 100
Global
Innovator
2020

Electric Products

MCB / MC&TOR / MMS / MCCB /
ACB / FDB / SMDB / VCB



LS ELECTRIC

Electric Products

Customer satisfaction with world-class products and services
LS ELECTRIC is committed to excellence!



Miniature Circuit Breakers



Surge Protective Device



Vacuum Circuit Breakers



Air Circuit Breakers



Molded Case Circuit Breakers



Contactors & Overload Relays



Contents

Miniature Circuit Breakers	4
Residual Current Circuit Breakers	6
Surge Protective Device	8
Contactors & Overload Relays	16
Mini Contactors	26
Digital Motor Protection Relay	27
Manual Motor Starters	28
Molded Case Circuit Breakers	30
Earth Leakage Circuit Breakers	38
Air Circuit Breakers	42
LS Final Distribution Boards	52
LS SMDB Solution	56
Vacuum Circuit Breakers	60

Miniature Circuit Breakers

1, 2, 3 and 4pole series up to 125AF [IEC 60898-1, IEC 60947-2]

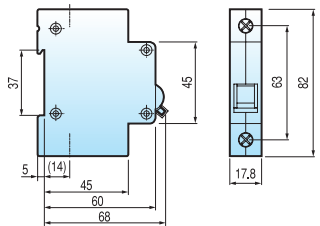
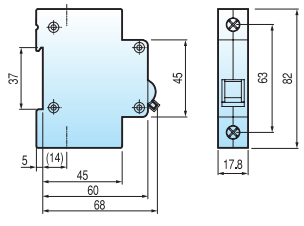
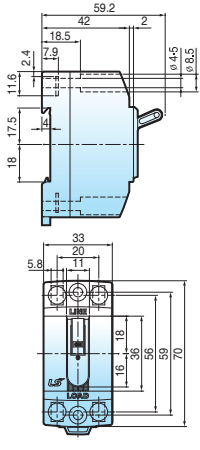

Type	MCB						
	BKN	BKN-c	BKN-b		BS32c	BS32d	
Protection	Overload and short circuit		Overload and short circuit		Overload and short circuit		
Rated current	1, 2, 3, 4, 6, 10, 13, 16, 20, 25, 32, 40, 50, 63A		1, 2, 3, 4, 6, 10, 16, 20, 25, 32, 40, 50, 63A		6, 10, 15, 20, 30A	10, 15, 20, 30A	
Characteristic	B, C, D curve		B, C, curve		-	-	
Poles	1P, 1P+N, 2P, 3P, 3P+N, 4P		1P, 1P+N, 2P, 3P, 3P+N, 4P		-	-	
Breaking capacity	1pole		1pole		2pole		
	1A ~ 63A 6kA at 230/400VAC		1A ~ 63A 6kA at 400VAC		1.5kA	2.5kA	
Standard	IEC 60898-1		IEC 60898-1, IEC 60947-2		IEC 60898-1, KS		
Approval	CCC, SABS, SEMKO CB		SEMKO CB		KEMA CB, SABS, CE	CCC	-
Type of trip	Thermal magnetic release		Thermal magnetic release		-	-	
Endurance	Electrical	4,000 operations		4,000 operations		4,000 operations	
	Mechanical	10,000 operations		10,000 operations		10,000 operations	
Mount	On 35mm DIN rail		On 35mm DIN rail		DIN rail / Screw		
Width	17.8mm per pole		17.8mm per pole		33mm per pole		
Terminal	Lug type (Cable up to 25mm ²)		Dual type (Lug & Screw)		Lug type (Cable up to 25mm ²)		Screw clamp type (Cable up to 5.5mm ²)
Auxiliary switch, AX & AL Optional	 <p>1 changeover contact 6A at 240VAC, 3A at 415VAC (AX) 6A at 230VAC, 3A at 415VAC (AL) 2A at 48VDC, 1A at 125VDC Lug terminal Cable capacity 2.5mm² 9mm wide *Only for BKN</p>		 <p>1 changeover contact 6A at 240VAC, 3A at 415VAC (AX/ AL) 6A at 24VDC, 2A at 48VDC, 1A at 130VDC Lug terminal Cable capacity 0.75~2.5mm² 8.8mm wide</p>				
Dimension							
Remarks	-		-		-		



MCB

BKH		BKP	BF-a	BF-c	BFN	
Overload and short circuit		Overload and short circuit	Overload and short circuit		Overload and short circuit	
63, 80, 100, 125A		3, 6, 10, 16, 20, 25, 32A	10-100A		5, 10, 15, 20, 30, 40, 50A	
C, D curve		B, C, D curve	-		-	
1P, 2P, 3P, 3P+N, 4P		1P+N	1p, 2p, 3p		1p, 2p, 3p	
1pole	2-4pole	-	-		1pole	2-3pole
63A ~ 125A 10kA at 230VAC	63A ~ 125A 10kA at 400VAC	3A ~ 32A 4.5kA at 230VAC	10A~100A 10kA at 240VAC 2.5kA at 415VAC	10A~100A 5kA at 240VAC 2.5kA at 415VAC	5A~50A 10kA at 230VAC	5A~50A 10kA at 400VAC
IEC 60947-2		IEC 60898-1	IEC 60947-2		IEC 60947-2	
CCC, SEMKO CB, SABS, CE		CCC, SEMKO CB, SABS, CE	-		SEMKO CB, CE	
Thermal magnetic release		Thermal magnetic release	Thermal magnetic release		Thermal magnetic release	
1,500 operations		4,000 operations	1,500 operations		1,500 operations	
10,000 operations		10,000 operations	10,000 operations		10,000 operations	
On 35mm DIN rail		On 35mm DIN rail	Holder mounting (Bolt on with fixing brackets)		Plug-in	
27mm per pole		17.8mm	25mm per pole		25mm per pole	
Lug type (Cable up to 50mm ²)		Lug type (Cable up to 10mm ²)	Clamp type		Lug type (14-6 AWG.)	
IEC 60947-2 (SABS)		-	-		-	

Residual Current Circuit Breakers

2 and 4 pole series up to 63AF



Type	RCBO				
	RKP	RKS	RKS-b	RKC	32KGRc 32KGRd
Protection	Ground fault and overcurrent	Ground fault and overcurrent	Ground fault and overcurrent	Ground fault and overcurrent	Ground fault and overcurrent
Rated current	3 (C, D curve), 6, 10, 16, 20, 25, 32A (B, C, D curve)	6, 10, 16, 20, 25, 32A (40, 50A)* (B, C curve)	6, 10, 16, 20, 25, 32A (B, C curve)	6, 10, 16, 20, 25, 32A (B, C curve)	15, 20, 30A
Rated residual current	-	-	-	-	-
Operating, $I_{\Delta n}$	30, 100, 300mA (Non-adjustable)	30, 100mA (Non-adjustable)	10, 30mA (Non-adjustable)	15, 30mA (Non-adjustable)	15, 30mA (Non-adjustable)
Non-operating, $I_{\Delta no}$	$0.5I_{\Delta n}$	$0.5I_{\Delta n}$	$0.5I_{\Delta n}$	$0.5I_{\Delta n}$	$0.5I_{\Delta n}$
Poles	1P+N	1P+N	1P+N	2pole	2pole
Rated voltage	230VAC	230VAC 240VAC	240VAC	240VAC	110/240VAC
Residual current off-time	≤ 0.1 sec.	≤ 0.3 sec.	≤ 0.1 sec.	≤ 0.1 sec.	≤ 0.03 sec.
Standard	IEC 61009	IEC 61009	IEC 61009	IEC 61009	IEC 61009, KS
Approval	CCC, SEMKO CB, CE, SABS	SEMKO CB, CE, SABS	SEMKO CB, CE	SEMKO CB, CE	CCC
Type of trip	-	-	-	-	-
Ground fault	Electronic	Electronic	Electronic	Electronic	Electronic
Overcurrent	Thermal-magnetic	Thermal-magnetic	Thermal-magnetic	Thermal-magnetic	Bimetallic
Breaking capacity	4.5kA	10kA	6kA (32A 4.5kA)	1.5kA 2.5kA	1.5kA 2.5kA
Conditional short circuit capacity	-	-	-	-	-
Endurance	Electrical: 4,000 operations Mechanical: 10,000 operations	4,000 operations 10,000 operations	4,000 operations 10,000 operations	4,000 operations 10,000 operations	4,000 operations 10,000 operations
Mount	On 35mm DIN rail	On 35mm DIN rail	On 35mm DIN rail	On 35mm DIN rail / Screw	On 35mm DIN rail / Screw
Width	35.6mm	18mm	18mm	35mm	35mm
Terminal	Lug type (Cable up to 10mm ²)	Lug type (Cable up to 10mm ²)	Lug type (Cable up to 10mm ²)	Screw clamp type (Cable up to 5.5mm ²)	Screw clamp type (Cable up to 5.5mm ²)
Type of operation	AC	AC	A/AC	-	-
Dimension					
Characteristic curve	See page 45	See page 45	-	-	-

* 40, 50A are available only for RKS-b

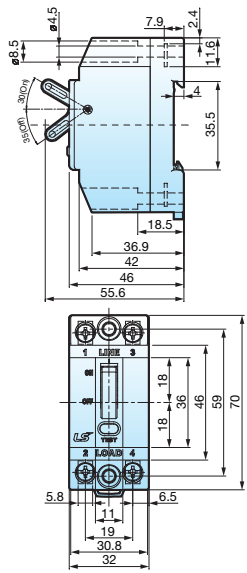
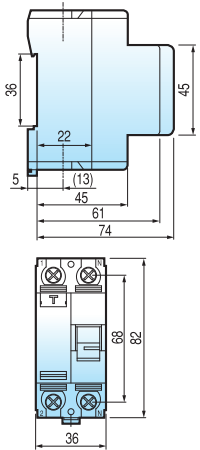
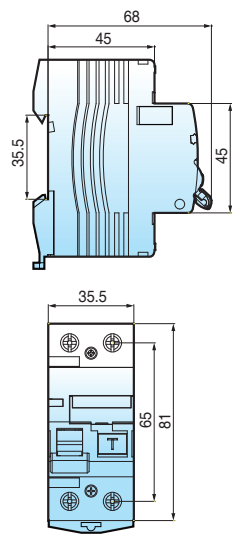

RCCB				RCCB		Isolator
32GRh			RKN	RKN-b		BKD
Ground fault and overcurrent			Ground fault			-
N type	S type	H type	25, 32, 40, 63A	63AF	100AF	40, 50, 63, 80, 100, 125A
15, 20, 30A				25, 40, 63A	80, 100A	
-			-			-
15, 30mA (Non-adjustable)			30, 100, 300mA (Non-adjustable)			-
0.5I _{Δn}			0.5I _{Δn}			-
2pole			1P+N, 3P+N			1p, 2p, 3p, 4p
110/220/230VAC			240VAC (1P+N), 240/415V (3P+N)			230/400VAC
≤0.03 sec			≤0.1 sec			-
CB(IEC60947/IEC61009-1)			IEC 61008			IEC 60947-3
-			SEMKO CB, CE, SABS, CCC	SEMKO CB, CE, SABS		SABS, SEMKO CB
-			-			-
Electronic Bimetallic			Electro-magnetic N.A			-
1.5kA	2.5kA	3.5kA	-			-
-			6kA	10kA		-
4,000 operations			4,000 operations			1,500 operations (125A 1,000 operations)
10,000 operations			10,000 operations			10,000 operations
On 35mm DIN rail / Screw			On 35mm DIN rail			On 35mm DIN rail
32mm			-			17.8mm per pole
Screw clamp type (Cable up to 5.5mm ²)			Lug type (Cable up to 35mm ²)			Lug type (Cable up to 50mm ²)
-			A/AC	A/AC	AC	-
						
-			-			-

Surge Protective Device

BK Series

Din-rail type

Product description

The BK Series AC/DIN type surge protect protects a 50/60Hz electric system from surge voltages. Also, the system allows replacement of the protective element (MOV), ensuring convenience and economy. However, as only the protective module is provided, other components should be added when the system is installed in accordance with the site condition. When the protective device is activated (in an anomaly or an accident), the red lever in the status indicator protrudes.



Product rating $U_c: 385V$

Item		AC Type						
		BK05S-T3	BK10S-T2	BK20S-T2	BK30S-T2	BK40S-T2	BK12S-T1 <small>Note4</small>	
No. of poles	[Pole]	2, 4P	1, 1+N, 2, 3, 3+N, 4P					
Rated voltages	U_n [V]	230/440V						
Max. continued-operation voltage	U_c [V]	-	385	385	385	385	385	385
		N-PE	-	255	255	255	255	255
Voltage protection level	U_p [kV]	-	≤ 0.8	≤ 1.5	≤ 1.8	≤ 2.0	≤ 2.5	≤ 2.5
		N-PE	-	≤ 1.0	≤ 1.2	≤ 1.5	≤ 2.0	≤ 2.5
	U_p [kV] [⊗]	-	≤ 2.0	≤ 1.5	≤ 1.8	-	≤ 2.5	-
		N-PE	-	≤ 2.5	≤ 2.5	-	≤ 3.5	-
Nominal discharge current	I_n [kA]	-	10	20	30	40	-	-
Max. discharge current	I_{max} [kA]	-	20	40	60	80	-	-
Impulse current	I_{imp} [kA]	-	-	-	-	-	-	12.5 (10/350)
Open circuit voltage	U_{oc} [kV]	10	-	-	-	-	-	-
Grades	Test class	Class III	Class II				Class I (Built-in type)	
Reaction time		<math>< 25ns</math>						
Status indication <small>Note2</small>		Have Status indication						
Operating temperature range		-40°C~80°C						
Cross-sectional area of the connecting wires		6~16mm ²	6~32mm ²				16~32mm ²	
Accessories		AL <small>Note3</small>					-	
Standard		IEC 61643-11 / KS C IEC 61643-11 / UL1449						
Certification		CE, UL, KS, S	CE, UL, KS, S	CE, UL, KS, S	CE, UL	CE, UL, KS, S	CE	

Note)

- When the protective device is activated (in an anomaly or an accident) in products with Class II and III indication features, the red lever in the status indicator protrudes.
- With a product with Class I indication feature, a green light will turn on when the protective device is in a normal condition. The green light will go off when the protective device is activated (for an anomaly or an accident.)
- The AL contact accessories are not sole separately. You need to choose these accessories when you place your order for the product. Please be mindful of this fact when you place your order.
- The Class I products are integrated with the MOVs, which cannot be detached.

Product description

The BK Series AC/DIN type surge protect protects a 50/60Hz electric system from surge voltages. Also, the system allows replacement of the protective element (MOV), ensuring convenience and economy. However, as only the protective module is provided, other components should be added when the system is installed in accordance with the site condition. When the protective device is activated (in an anomaly or an accident), the red lever in the status indicator protrudes.



Product rating <Uc: 460V>

Item		AC Type				
		BK10S-T2	BK20S-T2	BK30S-T2	BK40S-T2	
No. of poles	[Pole]	1, 1+N, 2, 3, 3+N, 4P				
Rated voltages	Un [V]	254/440V				
Max. continued-operation voltage	Uc [V]	-	460	460	460	460
		N-PE	255	255	255	255
Voltage protection level	Up [kV]	-	≤1.5	≤2.0	≤2.2	≤2.5
		N-PE	≤1.0	≤1.2	≤1.5	≤2.0
	Up [kV] Ⓢ	-	-	-	-	-
		N-PE	-	-	-	-
Nominal discharge current	In [kA]	10	20	30	40	
Max. discharge current	I _{max} [kA]	20	40	60	80	
Impulse current	I _{imp} [kA]	-	-	-	-	
Open circuit voltage	Uoc [kV]	-	-	-	-	
Grades	Test class	Class II				
Reaction time		< 25ns				
Status indication ^{Note2)}		Have Status indication				
Operating temperature range		-40℃~80℃				
Cross-sectional area of the connecting wires		6~32mm ²				
Accessories		AL ^{Note3)}				
Standard		IEC 61643-11, UL1449				
Certification		CE, S	CE, S, UL	CE, S, UL	CE, S, UL	

Note)

- When the protective device is activated (in an anomaly or an accident) in products with Class II and III indication features, the red lever in the status indicator protrudes.
- With a product with Class I indication feature, a green light will turn on when the protective device is in a normal condition. The green light will go off when the protective device is activated (for an anomaly or an accident.)
- The AL contact accessories are not sole separately. You need to choose these accessories when you place your order for the product. Please be mindful of this fact when you place your order.



Surge Protective Device

BK Series

DC Din-rail type

Product description

The BK Series DC/DIN type surge protect protects a DC electric system from surge voltages. Also, the system allows replacement of the protective element (MOV), ensuring convenience and economy. However, as only the protective module is provided, other components should be added when the system is installed in accordance with the site condition. When the protective device is in a normal condition, the indication display will be green. The display will turn black when the protective device is activated (for an anomaly or an accident.)



Product rating

Item	DC Type				
	BK20S-DC110	BK20S-DC600	BK20S-DC1000	BK20S-DC1500	
No. of poles	[Pole] 2P	3P			
Rated voltages	Un [V] DC110	DC600	DC1000	DC1500	
Max. continued-operation voltage	Uc [V] DC220	DC700	DC1200	DC1500	
Voltage protection level	Up [kV] ≤1.0	≤2.5	≤3.9	≤4.5	
Nominal discharge current	In [kA] 20	20	20	20	
Max. discharge current	I _{max} [kA] 40	40	40	40	
Impulse current	I _{imp} [kA] -	-	-	-	
Grades	Test Class	Class II			
Reaction time		< 25ns			
Status indication		Have Status indication			
Operating temperature range		-40°C~80°C			
Cross-sectional area of the connecting wires		6mm ² or more			
Accessories		AL ^{Note1)}			
Standard		IEC 61643-11 / UL1449			
Certification		CE	CE, UL	CE, UL	CE
SPD Disconnecter	MCCB	TD100 2P 32A	TD100 3P 32A	TD100 4P 32A	TSD250N/H 4P 63A (Under development)
	MCB	BK63H-DC 2P 40A	BK63H-DC 3P 40A	BK63H-DC 4P 40A	-

Note) 1. The AL contact accessories are not sole separately.
 You need to choose these accessories when you place your order for the product.
 Please be mindful of this fact when you place your order.



SD Series

SPD Disconnecter

Product description

SPD Disconnecter is a device that separates the SPD from the system during SPD failure and maintenance work. It has a trip function that can detect and cut off leakage current caused by SPD deterioration (varistor burnout, etc.) and has a high surge resistance to prevent the unintended trip operation of the Disconnecter.



Product rating

Item	SD10-T2	SD20-T2	SD30-T2	SD40-T2	SD13-T1
No. of poles	1, 2, 3, 4P				
Rated voltages	Ue [V] 230/400V				
Rated insulation voltage	Ui [V] 500V				
Voltage protection level	Up [kV] 0.25kV	0.4kV	0.5kV	0.7kV	0.3kV
Nominal discharge current	In [kA] 10kA	20kA	30kA	40kA	-
Max. discharge current	Imax [kA] 20kA	40kA	60kA	80kA	-
Impulse current	Iimp [kA] -	-	-	-	12.5kA
Grades	Test Class Class II, III	Class II			Class I
Short circuit current	Isc [kA] 25kA				
Frequency	50/60Hz				
Min. delay current	It 3A (<10s)				
Min. instantaneous current	Ii 5A (>0.1s), 10A(<0.1s)				
Protection degree	IP20				
Max. connection wire range	25mm ²				
AL connection wire range	1.5mm ²				
Operating temperature range	-25°C~60°C				
Ambient humidity	20%~90%				
Din-Rail	EN60715 (35mm)				

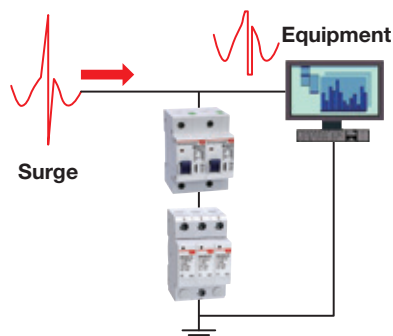

- Convenient SPD replacement
- High surge resistance
- Leakage current detection
- Prevent malfunctions in case of short circuit
- Easy installation using DIN rail

* AL available for SD20-T2 and SD-40T2

Surge Protective Device

SP Series

Box type

Product description

The SP series surge protective device is applied to the alternating current 50/60Hz, 220V/380V power system and provides the protection from the surge overvoltage of an electric system. Moreover, the protection module, disconnectable device (fuse), and fastened power and ground wires are organized into the all-in-one steel cabinet with convenient installation and stability.

If the protective device is normal, the display becomes green. The display becomes red after operation (abnormal or after an accident).



Product rating

- Single phase 2W+G (SPL)

SPD Type	SPL (AC 110/220V)		SPL (AC 220V)	
	SPL3-20S		SPL2-40S	SPL2-80S
Class	Class III		Class II	
Rated system [Pole]	2W+G		2W+G	
Rated voltage, Un AC [V]	110, 220		220	
Max. continuous operating voltage, Uc AC [V]	275		385	
Voltage protection level, Up [kV]	1.5		2.5	3.0
Operation voltage, Uoc [kV/kA]	20/10		20	40
Nominal discharge current, In (8/20 μ s) [kA, per mode]	-		40	80
Maximum discharge current, I _{max} (8/20 μ s) [kA, per mode]	-		-	-
Response time, tA [ns]	< 5 ns		< 5 ns	
Operating temperature range [°C]	-40 ~ +70°C		-40 ~ +70°C	
Operating frequency [Hz]	50/60 Hz		50/60 Hz	
Mounting on	Screw		Screw	
Operation status indication	Normal operation: Green, Abnormal/After an accident: Red			
Protection degree	IP20		IP20	
Protection mode	L-N, N-PE (G), L-PE (G)		L-N, N-PE (G)	
Ground	TN		TN	
Certification	CE		KS, CE	



Product rating

- Three phase 3W+G (SPT) AC 220V

SPD Type	SPT (AC 220V)			
	SPT2-40S	SPT2-80S	SPT1-120S	SPT1-160S
Class	Class II		Class I, Class II	
Rated system [Pole]	3W+G			
Rated voltage, Un AC [V]	220			
Max. continuous operating voltage, Uc AC [V]	385			
Voltage protection level, Up [kV]	2.5	3.0	2.0	2.0
Nominal discharge current, In (8/20 μ s) [kA, per mode]	20	40	-	-
Maximum discharge current, I _{max} (8/20 μ s) [kA, per mode]	40	80	120	160
Lightning impulse current, I _{imp} (10/350 μ s) [kA, per mode]	-	-	6.5	6.5
Response time, tA [ns]	< 5 ns			
Operating temperature range [°C]	-40 ~ +70°C			
Operating frequency [Hz]	50/60 Hz			
Mounting on	Screw			
Operation status indication	Normal operation: Green, Abnormal/After an accident: Red			
Protection degree	IP20			
Protection mode	L-PE (G)			
Ground	TN			
Certification	KS, CE			

* SPT can not be used in Delta wiring grounding system

Product rating

- Three phase 3W+G (SPT) AC 380V



SPD Type	SPT (AC 380V)			
	SPT2-40S	SPT2-80S	SPT1-120S	SPT1-160S
Class	Class II		Class I, Class II	
Rated system [Pole]	3W+G			
Rated voltage, Un AC [V]	380			
Max. continuous operating voltage, Uc AC [V]	385			
Voltage protection level, Up [kV]	2.5	3.0	2.0	2.0
Nominal discharge current, In (8/20 μ s) [kA, per mode]	20	40	-	-
Maximum discharge current, I _{max} (8/20 μ s) [kA, per mode]	40	80	120	160
Lightning impulse current, I _{imp} (10/350 μ s) [kA, per mode]	-	-	6.5	6.5
Response time, tA [ns]	< 5 ns			
Operating temperature range [°C]	-40 ~ +70°C			
Operating frequency [Hz]	50/60 Hz			
Mounting on	Screw			
Operation status indication	Normal operation: Green, Abnormal/After an accident: Red			
Protection degree	IP20			
Protection mode	L-PE (G)			
Ground	TN			
Certification	KS, CE			

* SPT can not be used in Delta wiring grounding system

Product rating

- Three phase 3W+G (SPT) AC 440V



SPD Type	SPT (AC 440V)			
	SPT2-40S	SPT2-80S	SPT1-120S	SPT1-160S
Class	Class II		Class I, Class II	
Rated system [Pole]	3W+G			
Rated voltage, Un AC [V]	440			
Max. continuous operating voltage, Uc AC [V]	385			
Voltage protection level, Up [kV]	2.5	3.0	2.0	2.0
Nominal discharge current, In (8/20 μ s) [kA, per mode]	20	40	-	-
Maximum discharge current, I _{max} (8/20 μ s) [kA, per mode]	40	80	120	160
Lightning impulse current, I _{imp} (10/350 μ s) [kA, per mode]	-	-	6.5	6.5
Response time, tA [ns]	< 5 ns			
Operating temperature range [°C]	-40 ~ +70°C			
Operating frequency [Hz]	50/60 Hz			
Mounting on	Screw			
Operation status indication	Normal operation: Green, Abnormal/After an accident: Red			
Protection degree	IP20			
Protection mode	L-PE (G)			
Ground	TN			
Certification	KS, CE			

* SPT can not be used in Delta wiring grounding system

Surge Protective Device

SP Series

Box type

Product rating

- Three phase 4W +G (SPY) 127S



SPD Type	SPY (AC 127/220V)				
	SPY2-40S	SPY2-80S	SPY1-120S	SPY1-160S	SPY1-200S *
Class	Class II		Class I, Class II		
Rated system [Pole]	4W+G				
Rated voltage, Un AC [V]	127/220				
Max. continuous operating voltage, Uc AC [V]	385				
Voltage protection level, Up [kV]	2.5	3.0	2.0	2.0	2.0
Nominal discharge current, In (8/20 μ s) [kA, per mode]	20	40	-	-	-
Maximum discharge current, Imax (8/20 μ s) [kA, per mode]	40	80	120	160	200
Lightning impulse current, Iimp (10/350 μ s) [kA, per mode]	-	-	6.5	6.5	12.5
Response time, tA [ns]	< 5 ns				
Operating temperature range [°C]	-40 ~ +70°C				
Operating frequency [Hz]	50/60 Hz				
Mounting on	Screw				
Operation status indication	Normal operation: Green, Abnormal/After an accident: Red				
Protection degree	IP20				
Protection mode	L-N, N-PE (G)				
Ground	TN				
Certification	KS, CE				

* The wiring direction of SPY1-200S is located on the side. (Refer to external dimension)

Product rating

- Three phase 4W+G (SPY) 220S



SPD Type	SPY (AC 220/380V)				
	SPY2-40S	SPY2-80S	SPY1-120S	SPY1-160S	SPY1-200S *
Class	Class II		Class I, Class II		
Rated system [Pole]	4W+G				
Rated voltage, Un AC [V]	220/380				
Max. continuous operating voltage, Uc AC [V]	385				
Voltage protection level, Up [kV]	2.5	3.0	2.0	2.0	2.0
Nominal discharge current, In (8/20 μ s) [kA, per mode]	20	40	-	-	-
Maximum discharge current, Imax (8/20 μ s) [kA, per mode]	40	80	120	160	200
Lightning impulse current, Iimp (10/350 μ s) [kA, per mode]	-	-	6.5	6.5	12.5
Response time, tA [ns]	< 5 ns				
Operating temperature range [°C]	-40 ~ +70°C				
Operating frequency [Hz]	50/60 Hz				
Mounting on	Screw				
Operation status indication	Normal operation: Green, Abnormal/After an accident: Red				
Protection degree	IP20				
Protection mode	L-N, N-PE (G)				
Ground	TN				
Certification	KS, CE				

* The wiring direction of SPY1-200S is located on the side. (Refer to external dimension)

Product rating

- limp 12.5kA Class I SPD



SPD Type	SPL1-13/50S	SPT1-13S	SPY1-13/50S
Class	Class I		
Rated system [Pole]	2W+G	3W+G	4W+G
Rated voltage, Un AC [V]	220	380	380/220
Max. continuous operating voltage, Uc AC [V]	320		
Voltage protection level, Up [kV]	L-N : 1.2, N-PE : 1.8	L-N : 1.2, N-PE : 1.8	L-N : 1.2, N-PE : 1.8
Nominal discharge current, In (8/20 μ s) [kA, per mode]	-	-	-
Maximum discharge current, I _{max} (8/20 μ s) [kA, per mode]	-	-	-
Lightning impulse current, I _{imp} (10/350 μ s) [kA, per mode]	12.5/50	12.5	12.5/50
Response time, t _A [ns]	< 5 ns		
Operating temperature range [°C]	-40 ~ +70°C		
Operating frequency [Hz]	50/60 Hz		
Mounting on	Screw		
Operation status indication	Normal operation: Green, Abnormal/After an accident: Red		
Protection degree	IP20		
Protection mode	L-N, N-PE (G)	L-PE (G)	L-N, N-PE (G)
Ground	TN/TT/IT		
Certification	KS, CE		

* SPT can not be used in Delta wiring grounding system

Product rating

- limp 25kA Class I SPD



SPD Type	SPL1-25/50S	SPT1-25S	SPY1-25/100S
Class	Class I		
Rated system [Pole]	2W+G	3W+G	4W+G
Rated voltage, Un AC [V]	220	380	380/220
Max. continuous operating voltage, Uc AC [V]	320		
Voltage protection level, Up [kV]	L-N : 1.3, N-PE : 2.0	L-N : 1.3, N-PE : 2.0	L-N : 1.3, N-PE : 2.0
Nominal discharge current, In (8/20 μ s) [kA, per mode]	-	-	-
Maximum discharge current, I _{max} (8/20 μ s) [kA, per mode]	-	-	-
Lightning impulse current, I _{imp} (10/350 μ s) [kA, per mode]	25/50	25	25/100
Response time, t _A [ns]	< 5 ns		
Operating temperature range [°C]	-40 ~ +70°C		
Operating frequency [Hz]	50/60 Hz		
Mounting on	Screw		
Operation status indication	Normal operation: Green, Abnormal/After an accident: Red		
Protection degree	IP20		
Protection mode	N-PE (G)	L-PE (G)	L-N, N-PE (G)
Ground	TN/TT/IT		
Certification	KS, CE		

* SPT can not be used in Delta wiring grounding system

Contactors & Overload relays

Metasol MC 3P 18 to 150A

MC type Magnetic Contactors



Frame size			18AF				22AF				
Type			MC-6a	MC-9a	MC-12a	MC-18a	MC-9b	MC-12b	MC-18b	MC-22b	
	Screws clamp terminals		●	●	●	●	●	●	●	●	
	Lug clamp terminals		-	-	-	-	-	-	-	-	
Number of poles			3pole				3pole				
Rated operational voltage, Ue			690V				690V				
Rated insulation voltage, Ui			690V				690V				
Rated frequency			50/60Hz				50/60Hz				
Rated impulse withstand voltage, Uimp			6kV				6kV				
Maximum operating rate in operating cycles per hour(AC3)			1800 operations per hour				1800 operations per hour				
Durability	Mechanical		15 mil. operations				15 mil. operations				
	Electrical		2.5 mil. operations				2.5 mil. operations				
Current and power	AC-1, Thermal current	A	25	25	25	32	25	27	32	45	
	AC-3	200/240V	kW	2.2	2.5	3.5	4.5	2.5	3.5	4.5	5.5
			A	9	11	13	18	11	13	18	22
		380/440V	kW	3	4	5.5	7.5	4	5.5	7.5	11
			A	7	9	12	18	9	12	18	22
		500/550V	kW	3	4	7.5	7.5	4	7.5	7.5	15
			A	6	7	12	13	7	12	13	20
		690V	kW	3	4	7.5	7.5	4	7.5	7.5	15
			A	4	5	9	9	6	9	9	18
		1000V	kW	-	-	-	-	-	-	-	-
		A	-	-	-	-	-	-	-	-	
Rated Short-time withstand current (IEC 60947)	1s	A	210	250	280	300	250	280	300	400	
	10s	A	105	110	120	130	110	120	154	186	
	30s	A	70	70	80	85	70	80	100	130	
	1min	A	61	61	61	70	61	61	84	90	
	3min	A	40	45	47	50	45	50	60	60	
	10min	A	30	30	30	40	30	30	40	50	
UL rating (50/60Hz)	≥15min	A	25	26	28	30	26	28	30	45	
	Continuous current	A	25	25	25	32	25	25	40	40	
	Single phase	110~120V	HP	0.5	0.5	0.75	1	0.5	0.75	1	2
		220~240V	HP	1.5	1.5	2	3	1.5	2	3	3
		200~208V	HP	2	2	3	7.5	2	3	7.5	7.5
	Three phase	220~240V	HP	3	3	5	7.5	3	5	7.5	10
		440~480V	HP	5	5	7.5	10	5	7.5	10	15
		550~600V	HP	7.5	7.5	10	15	7.5	10	15	20
Size and weight	NEMA size		00	00	0	1	00	0	1		
	AC control	Weight	0.33				0.34				
		Size(W×H×D)	45×73.5×80.4				45×73.5×87.4				
	DC control	Weight	0.4				0.41				
	Size(W×H×D)	45×73.5×96.6				45×73.5×103.6					
Auxiliary(standard)			1NO or 1NC				1NO1NC				
Auxiliary	Side mount		UA-1				UA-1				
	Front mount		UA-2, UA-4				UA-2, UA-4				

Note) Minimum conduct current of Auxiliary contactor is DC 17V 5mA.

MT type Thermal Overload Relays



Type		MT-12/□	MT-32/□	
	Screws clamp terminals	●	●	
	Lug clamp terminals	-	-	
Rated operational voltage, Ue		690V	690V	
Rated insulation voltage, Ui		690V	690V	
Rated impulse withstand voltage, Uimp		6kV	6kV	
Trip class		10A, 20	10A, 20	
Setting range		0.1~18A	0.1~40A	
Size and weight	Weight	kg	0.1	0.17
	Size(W×H×D)	mm	45×73.2×63.7	45×75×90

* The safety cover of magnetic contactor and thermal overload relay is optional.



40AF		65AF		100AF			150AF	
MC-32a	MC-40a	MC-50a	MC-65a	MC-75a	MC-85a	MC-100a	MC-130a	MC-150a
•	•	•	•	•	•	•	•	•
-	-	•	•	•	•	•	•	•
3pole		3pole		3pole			3pole	
1000V		1000V		1000V			1000V	
1000V		1000V		1000V			1000V	
50/60Hz		50/60Hz		50/60Hz			50/60Hz	
8kV		8kV		8kV			8kV	
1800 operations per hour		1800 operations per hour		1800 operations per hour			1200 operations per hour	
12 mil. operations		12 mil. operations		12 mil. operations			5 mil. operations	
2 mil. operations		2 mil. operations		2 mil. operations		1 mil. operations	4 mil. operations	
55	60	100	115	125	135	160	200	250
7.5	11	15	18.5	22	25	30	37	45
32	40	55	65	75	85	105	130	150
15	18.5	22	30	37	45	55	60	75
32	40	50	65	75	85	105	130	150
18.5	22	30	33	37	45	55	60	70
28	32	43	60	64	75	85	90	100
18.5	22	30	33	37	45	55	55	55
20	23	28	35	42	45	65	60	60
22	22	30	30	37	37	37	75	75
17	17	23	23	28	28	28	50	50
600	700	1000	1050	1100	1200	1320	1350	1800
260	300	550	700	750	800	900	950	1200
160	190	330	380	400	450	500	700	800
100	120	250	270	300	350	400	550	600
70	80	150	200	220	270	270	350	450
55	65	90	120	140	170	180	200	300
50	60	87	96	114	150	160	175	280
50	60	70	100	110	135	160	200	250
2	3	3	5	5	7.5	10	10	15
5	7.5	10	15	15	15	20	20	25
7.5	15	20	25	25	30	30	40	40
10	15	25	30	30	40	40	40	50
20	30	40	50	50	60	75	75	100
25	30	50	60	60	75	75	75	75
1P	2				3			4
0.55		1.05		1.93			2.4	
69×83×90		79×106×119		94×140×135.8			119×158×130.3	
0.77		1.3		2.8				
69×83×117.1		79×106×146.4		94×140×172.3				
2NO2NC		2NO2NC		2NO2NC			2NO2NC	
UA-1		UA-1		UA-1			UA-1	
UA-2, UA-4		UA-2, UA-4		UA-2, UA-4			UA-2, UA-4	

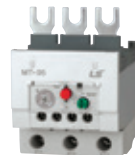

MT-32/□	MT-63/□	MT-95/□	MT-150/□
•	•	•	•
-		•	•
690V	690V	690V	690V
690V	690V	690V	690V
6kV	6kV	6kV	6kV
10A, 20	10A, 20	10A, 20	10A, 20
0.1~40A	4~65A	7~100A	34~150A
0.17	0.31/0.33	0.48/0.5	0.67
45×75×90	55×81×100	70×97×110	95×109×113

Contactors & Overload relays

Metasol MC 3P 225 to 2100A



MC type Magnetic Contactors

Frame size			225AF		400AF			
Type	Screws clamp terminals		MC-185a	MC-225a	MC-265a	MC-330a	MC-400a	
	Lug clamp terminals		-	-	-	-	-	
Number of poles			3pole		3pole			
Rated operational voltage, Ue			1000V		1000V			
Rated insulation voltage, Ui			1000V		1000V			
Rated frequency			50/60Hz		50/60Hz			
Rated impulse withstand voltage, Uimp			8kV		8kV			
Maximum operating rate in operating cycles per hour(AC3)			1200 operations per hour		1200 operations per hour			
Durability	Mechanical		5 mil. operations		5 mil. operations		2.5 mil. operations	
	Electrical		1 mil. operations		1 mil. operations		0.5 mil. operations	
Current and power	AC-1, Thermal current	A	300	350	400	500	520	
		AC-3 200/240V	kW	55	75	80	90	125
	380/440V	kW	185	225	265	330	400	
		A	90	132	147	160	200	
	500/550V	kW	185	225	265	330	400	
		A	110	132	147	160	225	
	690V	kW	180	200	225	250	350	
		A	110	140	160	200	250	
	1000V	kW	120	150	185	220	300	
		A	132	132	147	147	147	
Rated Short-time withstand current (IEC 60947)	1s	A	2000	2500	3500	4000	4600	
	10s	A	1500	1700	2400	3000	4400	
	30s	A	1000	1200	1500	2500	2974	
	1min	A	800	1000	1100	1700	1846	
	3min	A	520	700	800	1000	1313	
	10min	A	350	500	600	620	760	
	≥15min	A	320	400	500	553	699	
UL rating (50/60Hz)	Continuous current		A	300	350	400	500	520
	Single phase	110~120V	HP	15	15	-	-	-
		220~240V	HP	30	40	-	-	-
	Three phase	200~208V	HP	60	60	75	100	125
		220~240V	HP	60	75	100	100	150
		440~480V	HP	125	150	200	200	300
	550~600V	HP	125	150	200	200	300	
NEMA size					5			
Size and weight	AC control	Weight	kg		9.2			
		Size(W×H×D)	mm		163×243×204.4			
	DC control	Weight	kg		5.4			
		Size(W×H×D)	mm		138×203×185.1			
Auxiliary(standard)			2NO2NC		2NO2NC			
Auxiliary			AU-100, AU-100E (Max.4NO4NC)		AU-100, AU-100E (Max.4NO4NC)			
Side mount			-		-			
Front mount			-		-			

MT type Thermal Overload Relays

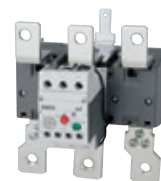

Type			MT-225/□	MT-400/□
Type	Screws clamp terminals		●	●
	Lug clamp terminals		-	-
Rated operational voltage, Ue			690V	690V
Rated insulation voltage, Ui			690V	690V
Rated impulse withstand voltage, Uimp			6kV	6kV
Trip class			10A, 20	10A, 20
Setting range			65~240A	85~400A
Size and weight		Weight	kg	2.5
		Size(W×H×D)	mm	147×141×184
				2.6
			147×141×184	151×171×198

* The safety cover of magnetic contactor and thermal overload relay is optional.



800AF			1260AF	2650AF			
MC-500a	MC-630a	MC-800a	MC-1260a	MC-1400a	MC-1700a	MC-2100a	MC-2650a
●	●	●	●	●	●	●	●
-	-	-	-	-	-	-	-
3pole			3pole	3pole			
1000V			1000V	1000V			
1000V			1000V	1000V			
50/60Hz			50/60Hz	50/60Hz			
8kV			8kV	8kV			
1200 operations per hour			300 operations per hour	300 operations per hour			
2.5 mil. operations			0.5 mil. operations	0.5 mil. operations			0.3 mil. operations
0.5 mil. operations			0.05 mil. operations	0.05 mil. operations			0.02 mil. operations
700	900	1050	1260	1400	1700	2100	2650
147	190	220	-	290	310	-	-
500	630	800	-	860	1050	-	-
265	330	440	-	550	700	900	-
500	630	800	-	860	1050	1450	-
265	330	500	-	-	-	-	-
400	500	720	-	-	-	-	-
300	400	500	-	800	1000	-	-
380	420	630	-	800	950	-	-
280	280	280	-	-	-	-	-
220	220	220	-	-	-	-	-
6000	7000	7500	8000	-	-	-	-
5050	6400	7000	7200	8000	10000	10000	10000
4400	4500	4900	5200	-	-	-	-
3400	3500	3800	4000	4500	5500	5500	5500
2000	2200	2500	2300	-	-	-	-
1400	1550	1550	3000	2600	3000	3000	3000
1100	1300	1300	1500	-	-	-	-
700	900	1050	1260	1400	1700	2100	2650
-	-	-	-	-	-	-	-
-	-	-	-	-	-	-	-
150	200	200	-	-	-	-	-
200	250	300	-	-	-	-	-
400	500	600	-	-	-	-	-
400	500	600	-	-	-	-	-
6	-	7	-	-	-	-	-
22.2 285×310×246			24 285×352×246	33.8 431×380×246			47 431×392×246
2NO+2NC			2NO+2NC	2NO+2NC			
AU-100, AU-100E (Max.4NO4NC)			AU-100, AU-100E (Max.4NO4NC)	AU-100, AU-100E (Max.4NO4NC)			
-			-	-			



MT-800/□
●
-
690V
690V
6kV
10A, 20
200~800A
11.5
360×530×212

Contactors

Metasol MC 4P 18 to 85A

MC type Magnetic Contactors



Frame size				18AF			
Type				MC-6a/4	MC-9a/4	MC-12a/4	MC-18a/4
Screw clamp terminal				•	•	•	•
Number of poles				4pole			
Rated operational voltage (Ue)				690V			
Rated insulation voltage (Ui)				690V			
Rated frequency				50/60Hz			
Rated impulse withstand voltage, Uimp				6kV			
Maximum operating rate in operating cycles per hour(AC1)				1800 operations per hour			
Durability				15 mil. operations			
Mechanical				15 mil. operations			
Electrical				0.5 mil. operations		0.8 mil. operations	
Current and Power	Thermal current		A	25	25	25	40
	AC-1	200/240V	kW	9	9	9	15
			A	25	25	25	40
		380/400V	kW	17	17	17	27
			A	25	25	25	40
		500/550V	kW	21	21	21	35
			A	25	25	25	40
	690V	kW	27	27	27	44	
		A	25	25	25	40	
UL rating (50/60Hz)	Continuous current		A	25	25	25	32
	Single	110~120V	HP	0.5	0.5	0.75	1
		Phase	220~240V	HP	1.5	1.5	2
	Three	200~208V	HP	2	2	3	7.5
		Phase	220~240V	HP	3	3	5
		440~480V	HP	5	5	7.5	10
	550~600V	HP	7.5	7.5	10	15	
Size and weight	AC	Weight	kg	0.33			
		Control	Size(W×H×D)	45×73.5×80.4			
	DC	Weight	kg	0.4			
		Control	Size(W×H×D)	45×73.5×96.6			
Auxiliary(standard)				-			
Auxiliary	Side Mount			UA-1			
	Front Mount			UA-2, UA-4			





22AF	40AF		85AF			
MC-22a/4	MC-32a/4	MC-40a/4	MC-50a/4	MC-65a/4	MC-75a/4	MC-85a/4
•	•	•	•	•	•	•
4pole	4pole		4pole			
690V	690V		690V			
690V	690V		1000V			
50/60Hz	50/60Hz		50/60Hz			
6kV	6kV		8kV			
1800 operations per hour	1800 operations per hour		1800 operations per hour			
15 mil. operations	15 mil. operations		12 mil. operations			
1 mil. operations	1 mil. operations		1 mil. operations			
40	50	60	80	100	110	135
15	18	22	30	37	41	51
40	50	60	80	100	110	135
27	35	42	56	70	76	95
40	50	60	80	100	110	135
35	43	52	70	88	97	120
40	50	60	80	100	110	135
44	55	66	88	110	120	150
40	50	60	80	100	110	135
32	45	50	70	80	90	100
2	2	3	3	5	5	7.5
3	5	5	7.5	10	15	15
7.5	7.5	10	10	15	20	25
7.5	10	10	15	20	25	30
10	20	25	30	40	50	50
15	20	25	30	40	50	50
0.4	0.59		1.2			
47.2×80×86.8	59×83.5×94.5		91×123.5×117.8			
0.5	0.7		1.29			
47.2×80×113.2	59×83.5×121		91×123.5×117.8			
-	-		-			
AU-1	AU-1		AU-1			
UA-2, UA-4	UA-2, UA-4		UA-2, UA-4			

Contactors

Metasol MC 4P 225 to 800A

MC type Magnetic Contactors



Frame size				225AF				
Type	Screw clamp terminal			MC-100a/4	MC-130a/4	MC-150a/4	MC-185a/4	MC-225a/4
Number of poles				4pole				
Rated operational voltage (Ue)				690V				
Rated insulation voltage (Ui)				1000V				
Rated frequency				50/60Hz				
Rated impulse withstand voltage, Uimp				8kV				
Maximum operating rate in operating cycles per hour(AC1)				1200 operations per hour				
Durability	Mechanical			5 mil. operations				
	Electrical			0.8 mil. operations				
Current and Power	Thermal current	A		200	250	275	300	350
		AC-1	200/240V	kW	57	60	76	87
	380/400V	A		200	250	275	300	350
		kW		106	110	142	165	185
		A		200	250	275	300	350
		kW		132	137	180	205	230
		A		200	250	275	300	350
500/550V	kW		165	170	225	255	290	
	A		200	250	275	300	350	
UL rating (50/60Hz)	Continuous current	A		200	250	275	300	350
		Single	110~120V	HP	7.5	10	15	15
	Phase	220~240V	HP	15	20	25	30	40
		Three	200~208V	HP	30	40	40	60
	Phase	220~240V	HP	30	40	50	60	75
		440~480V	HP	60	75	100	125	150
	550~600V	HP	60	75	100	125	150	
Size and weight	AC	Weight	kg	5.6				
		Control	Size(W×H×D)	mm	175×203×185			
	DC	Weight	kg					
		Control	Size(W×H×D)	mm				
Auxiliary(standard)				2NO2NC				
Auxiliary	Side Mount			AU-100 / AU-100E				
	Front Mount			-				

* - FLA = 722 A, LRA = 5618 A

** - FLA = 566 A, LRA = 4495 A



400AF			800AF		
MC-265a/4	MC-330a/4	MC-400a/4	MC-500a/4	MC-630a/4	MC-800a/4
•	•	•	•	•	•
	4pole			4pole	
	690V			690V	
	1000V			1000V	
	50/60Hz			50/60Hz	
	8kV			8kV	
	1200 operations per hour			1200 operations per hour	
	2.5 mil. operations			2.5 mil. operations	
	0.5 mil. operations			0.5 mil. operations	
400	500	520	700	900	1050
115	135	160	245	255	310
400	500	520	700	900	1050
215	250	300	450	470	570
400	500	520	700	900	1050
265	315	375	560	590	710
400	500	520	700	900	1050
335	390	470	710	740	900
400	500	520	700	900	1050
400	500	520	700	900	1050
-	-	-	-	-	-
-	-	-	-	-	-
75	100	125	150	200	200
100	125	150	200	250	300
200	200	300	400	500	600 *
200	200	300	400	500	600 **
	9.9			26.3	
	206×243×205			346×310 ×244	
2NO2NC			2NO2NC		
	AU-100			AU-100	
	-			-	

Contactors

Metasol MCI 3P 1260 to 2650A

Renewable Magnetic Contactor



- Eco-friendly contact material applied (Cd free)
- Type 2 coordination data with MCCB or ACB

Frame size			1260AF			
			MCI-900	MCI-1050	MCI-1260	
Type	Screw clamp terminals			●		
Number of poles		pole		3		
Rated operational voltage (Ue)		Vac		1000		
Rated insulation voltage (Ui)		Vac		1000		
Rated frequency		Hz		50/60		
Rated impulse withstand voltage (Uimp)		kV		8		
Mechanical operating cycle		cycles/hour	600	600	300	
Electrical operating cycle		cycles/hour	600	600	300	
Durability	Mechanical	million	100	100	50	
	Electrical (AC-1@690V)	million	26	26	15	
	Electrical (AC-1@400V)	million	50	50	20	
Current and Power (IEC)	AC-1 1000V 55/60/70°C	A	900/850/700	1050/875/720	1260/1060/900	
	Thermal current	A	900	1050	1260	
	Heat dissipation	W	100	170	170	
Rated Short-time withstand current(I _{cs}) (IEC 60947)	1s	A	7000	7500	8000	
	10s	A	6400	7000	7200	
	1min	A	3500	3800	4000	
	10min	A	1550	1550	2300	
max. breaking capacity (I _{cn})	400V	A	6000	7500	7500	
	690V	A	5000	7000	7000	
	1000V	A	2000	2500	2500	
Type-2 Coordination (with MCCB or ACB)		kA	42kA (Break time: less than 20ms)			
Current and HP (UL)	Thermal current		900	1050	1260	
	Single phase	110~120V	HP	-	-	-
		220~240V	HP	-	-	-
	Three phase	200~208V	HP	200	200	-
		220~240V	HP	250	300	-
		440~480V	HP	500	600	-
550~600V		HP	500	600	-	
Weight (kg)			22.2	22.2	25	
Size (W×H×D)		mm	285×310×246	285×310×246	285×352×246	
Auxiliary(standard)			2NO2NC			
Auxiliary	Side Mount		AU-100, AU-100E (max.4NO4NC)			
	Front Mount		-			



2650AF		
MCI-1700	MCI-2100	MCI-2650
	●	
	3	
	1000	
	1000	
	50/60	
	8	
	300	
300	300	120
50	50	30
5	5	2
5	5	5
1700/1450/1300	2100/1750/1500	2650/2350/2150
1700	2100	2650
220	350	350
	12000	
	10000	
	5500	
	3000	
9000	12000	1200
8000	8500	8500
3000	3150	3150
42kA (Break time: less than 50ms)		
1700	2100	2650
-	-	-
-	-	-
-	-	-
-	-	-
-	-	-
34.6	34.6	47
431×380×246	431×380×246	431×392×246
2NO2NC		
AU-100, AU-100E (max.4NO4NC)		
-		

Mini Contactors

6 to 16A

Mini contactors

3NO main contacts
1 auxiliary contacts



Screw clamp type



Fast-on type



Cage clamp type



Solder pin type

Frame size		6A		9A		12A		16A	
Screw clamp type	AC coil	GMC-6M		GMC-9M		GMC-12M		GMC-16M	
	DC coil	GMD-6M		GMD-9M		GMD-12M		GMD-16M	
Fast-on type	AC coil	GMC-6MF		GMC-9MF		GMC-12MF		GMC-16MF	
	DC coil	GMD-6MF		GMD-9MF		GMD-12MF		GMD-16MF	
Cage clamp type	AC coil	GMC-6MC		GMC-9MC		GMC-12MC		GMC-16MC	
	DC coil	GMD-6MC		GMD-9MC		GMD-12MC		GMD-16MC	
Solder pin type	AC coil	GMC-6MP		GMC-9MP		GMC-12MP		GMC-16MP	
	DC coil	GMD-6MP		GMD-9MP		GMD-12MP		GMD-16MP	
Ratings / IEC60947-4		kW A		kW A		kW A		kW A	
AC1		20		20		20		20	
AC3	200/240V	1.5	7	2.2	9	3	12	4	16
	380/440V	2.2	6	4	9	5.5	12	7.5	16
	500/550V	3	5	3.7	6	4	7	5.5	9
	690V	3	4	4	5	4	5	4	5
Ratings / UL508		hp A		hp A		hp A		hp A	
continuous current		I _{th} = 20A (maximum for cage clamp type is 10A)							
single phase	120V	1/2		1/2		1 *		-	
	230V/240V	1		1.5		2 **		-	
three phase	240V	1.5		3		3		-	
	480V	3		5		7.5 ***		-	
	600V	3		5		7.5		-	
Wire Range:		Copper, 75°C, Stranded, 18-12AWG							
NEMA size		00		00		00		0	
Additional auxiliary contacts		Screw clamp type		Fast-on type		Cage clamp type		Solder pin type	
2-pole, Front mount		AU-2M		AU-2MF		AU-2MC		AU-1MP	
	4-pole, Front mount	AU-4M		AU-4MF		AU-4MC			
	2-pole, Side mount	AU-1M		AU-1MF		AU-1MC			

Note) * = 1/2 for cage clamp type, ** = 1.5hp for cage clamp type, *** = 5hp for cage clamp type
16AF : not approved from UL

Overload Relays

Bimetallic style Type GT	<p>GT-12M</p>	Setting ranges (A) 0.1 - 0.16 0.16 - 0.25 0.25 - 0.4 0.4 - 0.63 0.63 - 1 1 - 1.6 1.6 - 2.5 2.5 - 4	4 - 6 5 - 8 6 - 9 7 - 10 9 - 13 12 - 16	<p>Base for separate mount</p>		
					Differential	GTK-12M
					Non-differential (3-heater)	GTH-12M/3
					Non-differential (2-heater)	GTH-12M

Digital Motor Protection Relay



DMPi

Rated specifications

Connection method		Penetrated / Terminal type
Protection functions		Overcurrent, phase fail, phase unbalance, stall, locked rotor, reverse phase, ground fault (Type option) Instance (Type option)
Connection method		Penetrated / Terminal type
Operating time characteristics		Thermal heat build-up inverse time / Non-thermal heat build-up inverse time / Definite time
Rated current		0.5~6A/5~65A (Rating option upon placing an order)
Display		4 digit, 7-Segment
Operating power		AC/DC 85~260V(50Hz/60Hz)
Reset method	Automatic	1~20min (only for overcurrent)
	Manual	(Electrical reset)
Installation / Mounting method		Display can be installed separately, 35mm DIN rail / Screw installation
Tolerance	Current	±3%
	Time	±5%
	4~20mA output	±5%
Time setting	Startup delay	1~200sec
	Operation delay	1~60sec
Aux. contact	Composition	3-SPST (Power supply 1a1b, instantaneous operation 1a) ^{Note1)}
	Capacity	3A/250VAC Resistive Load
	Contact minimum load	100mA / 6VDC : (95-996, 97-98) 10mA / 5VDC (07-08)
ZCT Input	External	200mA/100mV (Exclusive ZCT) ^{Note2)}
	Built-in	Support (Separate connection unnecessary) ^{Note2)}
Service environment	Service temperature	-20°C ~ 60°C
	Storage temperature	-30°C ~ 70°C
	Relative humidity	Below 50% RH (Without condensation)
Insulation resistance		100MΩ/500VDC
Lightning impulse voltage		1.2X50us 5kV Prototype waveform supply
Fast transient		2kV/1Min
Power consumption		Below 2W

Note) 1. See No. 21 to 23 of A-Group in Setting menu. If single phase is set, the device measures R/S/T phase. In HMI, the maximum phase of three phases is displayed without any indication of phase.

2. It is used when zero current detection type is selected.

3. This product is used to protect a low-voltage motor with 1000V or less.

Manual Motor Starters

Quick selection table ... IEC rating



Frame Size (AF)			32AF																			
Type	Current adjustable type		MMS-32S						MMS-32H													
	Instantaneous type		-						MMS-32HI													
	Breaking capacity		Standard						High breaking													
	Handle Type		Toggle						Rotary													
Number of poles			3						3													
Rated operational voltage (Ue)			Up to 690V						Up to 690V													
Rated frequency			50/60 Hz						50/60 Hz													
Rated insulation voltage (Ui)			690V						690V													
Rated impulse voltage (Uimp)			6kV						6kV													
Utilization category		IEC 60 947-2 (Breaker)	Cat. A						Cat. A													
		IEC 60 947-4 (Motor starter)	AC 3						AC 3													
Mechanical endurance (Operating)			100,000						100,000													
Electrical endurance (Cycles)			100,000						100,000													
Max operating frequency per hour (Ope./h)			25						25													
Temperature compensation (Operation)			-20 ~ +60°C						-20 ~ +60°C													
Instantaneous short circuit release			13 × Ie max.						13 × Ie max.													
Overload protection			○						○													
Phase failure function			○						○													
Trip indicating function			×						×													
Test function			○						○													
Dimension(W×H×D)			45×105×54.4						45×105×60.3													
Weight (g)			320						360													
Rated breaking capacity (kA)	Rated operational current (Ie)	Thermal release Adjustment range (A)	220V 240V 230V		415V 400V		460V 440V		525V 500V		690V 600V		220V 240V 230V		415V 400V		460V 440V		525V 500V		690V 600V	
			Icu	Ics	Icu	Ics	Icu	Ics	Icu	Ics	Icu	Ics	Icu	Ics	Icu	Ics	Icu	Ics	Icu	Ics	Icu	Ics
	0.16	0.1~0.16	100	100	100	100	100	100	100	100	100	100	100	100	100	100	100	100	100	100	100	100
	0.25	0.16~0.25	100	100	100	100	100	100	100	100	100	100	100	100	100	100	100	100	100	100	100	100
	0.4	0.25~0.4	100	100	100	100	100	100	100	100	100	100	100	100	100	100	100	100	100	100	100	100
	0.63	0.4~0.63	100	100	100	100	100	100	100	100	100	100	100	100	100	100	100	100	100	100	100	100
	1	0.63~1	100	100	100	100	100	100	100	100	100	100	100	100	100	100	100	100	100	100	100	100
	1.6	1~1.6	100	100	100	100	100	100	100	100	3	3	100	100	100	100	100	100	100	100	100	100
	2.5	1.6~2.5	100	100	100	100	100	100	50	38	3	3	100	100	100	100	100	100	100	100	100	8
	4	2.5~4	100	100	100	100	50	38	15	11	3	3	100	100	100	100	100	100	100	100	100	8
	6	4~6	100	100	100	100	15	11	10	8	3	3	100	100	100	100	100	100	100	100	100	6
	8	5~8	100	100	100	100	15	11	10	8	3	3	100	100	100	100	50	38	50	38	6	6
	10	6~10	100	100	50	38	15	11	6	5	3	3	100	100	100	100	50	38	50	38	6	6
	13	9~13	100	100	50	38	10	8	6	5	3	3	100	100	100	100	50	38	42	32	6	6
	17	11~17	50	38	20	15	10	8	6	5	3	3	100	100	50	38	20	15	10	8	4	4
	22	14~22	40	30	15	11	8	6	6	5	3	3	100	100	50	38	20	15	10	8	4	4
	26	18~26	40	30	15	11	8	6	5	4	3	3	100	100	50	38	20	15	10	8	4	4
	32	22~32	30	22	10	5	6	4	5	4	3	3	100	100	50	38	20	15	10	8	4	4
	40	28~40	20	15	10	5	5	3	4	3	2	2	100	100	40	30	15	11	8	6	3	3
	50	34~50	-	-	-	-	-	-	-	-	-	-	-	-	-	-	-	-	-	-	-	-
	63	45~63	-	-	-	-	-	-	-	-	-	-	-	-	-	-	-	-	-	-	-	-
	65	47~65	-	-	-	-	-	-	-	-	-	-	-	-	-	-	-	-	-	-	-	-
	75	55~75	-	-	-	-	-	-	-	-	-	-	-	-	-	-	-	-	-	-	-	-
	90	70~90	-	-	-	-	-	-	-	-	-	-	-	-	-	-	-	-	-	-	-	-
	100	80~100	-	-	-	-	-	-	-	-	-	-	-	-	-	-	-	-	-	-	-	-



63AF										100AF											
MMS-63S					MMS-63H					MMS-100S					MMS-100H						
Standard					High breaking					Standard					High breaking						
Rotary					Rotary					Rotary					Rotary						
3					3					3					3						
Up to 690V					Up to 690V					Up to 690V					Up to 690V						
50/60 Hz					50/60 Hz					50/60 Hz					50/60 Hz						
1,000V					1,000V					1,000V					1,000V						
8kV					8kV					8kV					8kV						
Cat. A					Cat. A					Cat. A					Cat. A						
AC 3					AC 3					AC 3					AC 3						
50,000					50,000					50,000					50,000						
25,000					25,000					25,000					25,000						
25					25					25					25						
-20 ~ +60°C					-20 ~ +60°C					-20 ~ +60°C					-20 ~ +60°C						
13 × Ie max.					13 × Ie max.					13 × Ie max.					13 × Ie max.						
○					○					○					○						
○					○					○					○						
×					×					○					○						
○					○					○					○						
55 × 125 × 112.3					55 × 125 × 112.3					70 × 165 × 138					70 × 165 × 138						
1,000					1,000					2,200					2,200						
220V 240V 230V	415V 400V	460V 440V	525V 500V	690V 600V	220V 240V 230V	415V 400V	460V 440V	525V 500V	690V 600V	220V 240V 230V	415V 400V	460V 440V	525V 500V	690V 600V	220V 240V 230V	415V 400V	460V 440V	525V 500V	690V 600V		
Icu	Ics	Icu	Ics	Icu	Ics	Icu	Ics	Icu	Ics	Icu	Ics	Icu	Ics	Icu	Ics	Icu	Ics	Icu	Ics	Icu	Ics
-	-	-	-	-	-	-	-	-	-	-	-	-	-	-	-	-	-	-	-	-	-
-	-	-	-	-	-	-	-	-	-	-	-	-	-	-	-	-	-	-	-	-	-
-	-	-	-	-	-	-	-	-	-	-	-	-	-	-	-	-	-	-	-	-	-
-	-	-	-	-	-	-	-	-	-	-	-	-	-	-	-	-	-	-	-	-	-
-	-	-	-	-	-	-	-	-	-	-	-	-	-	-	-	-	-	-	-	-	-
-	-	-	-	-	-	-	-	-	-	-	-	-	-	-	-	-	-	-	-	-	-
-	-	-	-	-	-	-	-	-	-	-	-	-	-	-	-	-	-	-	-	-	-
-	-	-	-	-	-	-	-	-	-	-	-	-	-	-	-	-	-	-	-	-	-
-	-	-	-	-	-	-	-	-	-	-	-	-	-	-	-	-	-	-	-	-	-
100	100	100	100	15	12	10	8	4	3	100	100	100	100	50	38	50	38	6	5	-	-
100	100	50	38	10	8	6	5	4	3	100	100	100	100	50	38	42	32	6	5	-	-
100	100	25	19	10	8	6	5	4	3	100	100	50	50	38	12	9	5	5	100	100	50
50	38	25	19	10	8	6	5	4	3	100	100	50	50	38	12	9	5	5	100	100	50
50	38	25	19	10	8	6	5	4	3	100	100	50	50	35	27	12	9	5	5	100	100
50	38	25	19	10	8	6	5	4	3	100	100	50	50	35	27	10	8	5	5	100	100
50	38	25	19	10	8	6	5	4	3	100	100	50	50	35	27	10	8	5	5	100	100
50	38	25	19	10	8	6	5	4	3	100	100	50	50	35	27	10	8	5	5	100	100
50	38	25	19	10	8	6	5	4	3	100	100	50	50	35	27	10	8	5	5	100	100
50	38	25	19	10	8	6	5	4	3	75	50	35	27	25	19	6	5	3	3	-	-
-	-	-	-	-	-	-	-	-	-	-	-	-	-	-	-	-	-	-	-	100	100
-	-	-	-	-	-	-	-	-	-	-	-	-	-	-	-	-	-	-	-	100	100
-	-	-	-	-	-	-	-	-	-	-	-	-	-	-	-	-	-	-	-	100	100

Molded Case Circuit Breakers

Susol MCCB 100AF to 800AF Series

Frame Size (AF)		TE100	TE160	TD100	TD160							
Frame size	[AF]	100	160	100	160							
Rated current, In *	[A]	16~100	100, 125, 160	16, 20, 25, 32, 40, 60, 63, 80, 100	100, 125, 160, 1P: 16~160							
No. of poles		3,4	3,4	2*, 3, 4	1, 2*, 3, 4							
Rated operational voltage, Ue	AC	690	690	690	690, 1P: 240							
	DC	500	500	500	500, 1P:250							
Rated impulse withstand voltage, Uimp	[kV]	8	8	8	8							
Rated insulation voltage, Ui	[V]	750	750	1000	1000							
Rated ultimate short-circuit breaking capacity, Icu		S	N	S	N	N	H	L	N	H	L	
AC 50/60Hz	220/240V	[kA]	50	85	50	85	85	100	200	85 (1P:30)	100 (1P:50)	200
	380/415V	[kA]	37	50	37	50	50	85	150	50	85	150
	440/460V	[kA]	25	37	25	37	50	70	130	50	70	130
	480/500V	[kA]	18	25	18	25	30	50	65	30	50	65
	525V	[kA]	-	-	-	-	22	35	50	22	35	50
	660/690V	[kA]	6	8	6	8	10	10	10	10	10	10
DC	250V	[kA]	37	50	37	50	42	65	100	42 (1P:16)	65 (1P:25)	100
	500V (2poles in series)	[kA]	37	50	37	50	42	65	100	42	65	100
Rated service breaking capacity, Ics												
AC 50/60Hz	220~525V	[%Icu]	100%	100%	100%	100%	100%	100%	100%	100%	100%	100%
	660/690V	[kA]	-	-	-	-	5	5	5	5	5	5
DC		[%Icu]	100%	100%	100%	100%	100%	100%	100%	100%	100%	100%
Rated short-circuit making capacity Icm												
AC 50/60Hz	220/240V	[kA]	105	187	105	187	187	220	440	187 (1P:105)	220 (1P:105)	440
	380/415V	[kA]	77.7	105	77.7	105	105	187	330	105	187	330
	440/460V	[kA]	52.5	77.7	52.5	77.7	105	154	286	105	154	286
	480/500V	[kA]	36	52.5	36	52.5	63	105	143	63	105	143
	525V	[kA]	-	-	-	-	46	74	105	46	74	105
	660/690V	[kA]	9.2	13.6	9.2	13.6	17	17	17	17	17	17
Category of utilization			A	A	A	A	A	A	A	A	A	A
Isolation behavior			●	●	●	●	●	●	●	●	●	●
Trip unit (release)												
Thermal-Magnetic												
● fixed-thermal, fixed-magnetic	FTU		●								●	
● adjustable-thermal, fixed-magnetic	FMU		●	●							●**	
● adjustable-thermal, adjustable-magnetic	ATU		-	-							-	
● magnetic only	MTU		-	-							-	
Electronic												
● LSI	ETS		-	-							-	
● LSI	ETM		-	-							-	
Option	Earth-fault protection, Ig		-	-							-	
	Zone selective interlocking, ZSI		-	-							-	
	Ammeter		-	-							-	
	Communication		-	-							-	
	Earth-leakage protection module		-	-							-	
Connection	fixed	front-connection	●	●				●			●	
		rear-connection	●	●			●				●**	
	plug-in	front-connection	-	-			●				●**	
		rear-connection	-	-			●				●**	
Mechanical life		[operations]	25000	25000				25000			25000	
Electrical life @ 415 V AC		[operations]	10000	10000				10000			10000	
Basic dimensions, W×H×D (front connection)	1-pole	[mm]	-	-				-			35×140×86	
	3-pole	[mm]	76×130×82	76×130×82				90×140×86			90×140×86	
	4-pole	[mm]	101×130×82	101×130×82				120×140×86			120×140×86	
Weight (front connection)	1-pole	[kg]	-	-				-			0.57	
	3-pole	[kg]	1.05	1.05				1.5			1.5	
	4-pole	[kg]	1.35	1.35				1.8			1.8	
Reference standard			IEC60947-2	IEC60947-2				IEC60947-2			IEC60947-2	

Note) ● applicable or available

* Applicable to MCCBs equipped with FTU, FMU, ATU ** Not applicable to 1pole
* 2 pole MCCB in 3pole frame size

※ The trip unit ATU is available from 125A



TS100			TS160			TS250			TS400			TS630			TS800		
100			160			250			400			630			800		
40, 50, 63, 80, 100			(100)*, 125, 160			125, 160, 200, 250			300, 400			500, 630			500, 630		
2*, 3, 4			2*, 3, 4			2*, 3, 4			2*, 3, 4			2*, 3, 4			2*, 3, 4		
690			690			690			690			690			690		
500			500			500			500			500			500		
8			8			8			8			8			8		
1000			1000			1000			1000			1000			1000		
N	H	L	N	H	L	N	H	L	N	H	L	N	H	L	N	H	L
100	120	200	100	120	200	100	120	200	100	120	200	100	120	200	100	120	200
50	85	150	50	85	150	50	85	150	65	85	150	65	85	150	65	85	150
50	70	130	50	70	130	50	70	130	65	85	130	65	85	130	65	85	130
42	65	85	42	65	85	42	65	85	42	65	85	42	65	85	42	65	85
22	35	50	22	35	50	22	35	50	22	35	50	22	35	50	22	35	50
10	10	10	10	10	10	10	10	10	10	20	35	10	20	35	10	20	35
50	85	100	50	85	100	50	85	100	50	85	100	50	85	100	50	85	100
50	85	100	50	85	100	50	85	100	50	85	100	50	85	100	50	85	100
100%	100%	100%	100%	100%	100%	100%	100%	100%	100%	100%	100%	100%	100%	100%	100%	100%	100%
5	5	5	5	5	5	5	5	5	10	12	12	10	12	12	10	20	20
100%	100%	100%	100%	100%	100%	100%	100%	100%	100%	100%	100%	100%	100%	100%	100%	100%	100%
220	264	440	220	264	440	220	264	440	220	264	440	220	264	440	220	264	440
105	187	330	105	187	330	105	187	330	143	187	330	143	187	330	143	220	330
105	154	286	105	154	286	105	154	286	143	187	286	143	187	286	143	220	286
88	143	187	88	143	187	88	143	187	88	143	187	88	143	187	88	187	220
46	74	105	46	74	105	46	74	105	46	74	105	46	74	105	46	74	105
17	17	17	17	17	17	17	17	17	17	40	74	17	40	74	17	40	74
A			A			A			A			A			A		
●			●			●			●			●			●		
●			●			●			●			●			●		
●			●			●			●			●			●		
-			●			●			●			●			●		
●			●			●			●			●			●		
●			●			●			●			●			●		
-			-			-			●			●			●		
-			-			-			●			●			●		
-			-			-			●			●			●		
-			-			-			●			●			●		
-			-			-			●			●			●		
●			●			●			●			●			●		
●			●			●			●			●			●		
●			●			●			●			●			●		
●			●			●			●			●			●		
25000			25000			25000			20000			20000			10000		
10000			10000			10000			10000			6000			3000		
-			-			-			-			-			-		
105x160x86			105x160x86			105x160x86			140x260x110			140x260x110			210x320x135		
140x160x86			140x160x86			140x160x86			186.5x260x110			186.5x260x110			280x320x135		
-			-			-			-			-			-		
2			2			2			5.4			5.4			15.1		
2.6			2.6			2.6			7.2			7.2			19.6		
IEC60947-2			IEC60947-2			IEC60947-2			IEC60947-2			IEC60947-2			IEC60947-2		
Calibrated for 40°C	Amb. Temp.	-5°C	0°C	10°C	20°C	25°C	30°C	35°C	40°C	45°C	50°C						
	TD160	122.5%	120.0%	115.0%	110.0%	107.5%	105.0%	102.5%	100.0%	97.5%	95.0%						
	TS250	122.5%	120.0%	115.0%	110.0%	107.5%	105.0%	102.5%	100.0%	97.5%	95.0%						
	TS630	110.0%	109.0%	107.0%	105.0%	104.0%	103.0%	101.5%	100.0%	98.5%	97.0%						
Calibrated for 50°C	TS800	110.0%	109.0%	107.0%	105.0%	104.0%	103.0%	101.5%	100.0%	98.5%	97.0%						
	TD160	122.0%	120.0%	116.0%	112.0%	110.0%	108.0%	106.0%	104.0%	102.0%	100.0%						
	TS250	122.0%	120.0%	116.0%	112.0%	110.0%	108.0%	106.0%	104.0%	102.0%	100.0%						
	TS630	122.2%	112.0%	110.0%	108.0%	107.0%	106.0%	104.5%	103.0%	101.5%	100.0%						
TS800	112.2%	112.0%	110.0%	108.0%	107.0%	106.0%	104.5%	103.0%	101.5%	100.0%							

Molded Case Circuit Breakers





Susol MCCB 1600AF Series

Electrical characteristics



Frame Size (AF)			TS1000			TS1250			TS1600				
Type			TS1000			TS1250			TS1600				
Ampere frame			1000			1250			1600				
Pole			3, 4			3, 4			3, 4				
Rated current, I _n (A)	-5~40°C		800, 1000			1250			1600				
	50°C		800, 1000			1250			1560				
	65°C		800, 1000			1240			1420				
Rated insulation voltage, U _i	(V)		1000			1000			1000				
Rated impulse withstand voltage, U _{imp}	(kV)		8			8			8				
Rated operational voltage, U _e	(V)		690			690			690				
	DC		-			-			-				
Rated short-circuit breaking capacity IEC60947-2 AC50/60Hz (sym)			N	H	L	N	H	N	H	N	H		
Rated ultimate short-circuit breaking capacity, (kA) (I _{cu})	220/240V		55	75	200	55	75	55	75	55	75		
	380/415V		50	70	150	50	70	50	70	50	70		
	440/460V		50	65	130	50	65	50	65	50	65		
	480/500V		40	50	100	40	50	40	50	40	50		
	660/690V		35	45	-	35	45	35	45	35	45		
DC	250V 2P		-	-	-	-	-	-	-	-	-		
	500V 2P		-	-	-	-	-	-	-	-	-		
	750V 3P		-	-	-	-	-	-	-	-	-		
Rated service breaking capacity (I _{cs})	%I _{cu}		100%	75%	100%	100%	75%	100%	75%	100%	75%		
Rated short-circuit making capacity (kA) (I _{cw})	AC50/60Hz		1s			25			25				
			3s			-			-				
Overriding instantaneous protection	kA peak		50			30			50				
Isolation			○			○			○				
Category			B			A			B				
(Life cycle)	Mechanical life (operations)		10000			4000			10000				
	Electrical life (operations)	440V	I _n /2		6000			4000			5000		
			I _n		5000			3000			4000		
		690V	I _n /2		4000			3000			3000		
I _n			2000			2000			2000				
Pollution degree			3			3			3				
Dimension (mm)	3-pole		210×327×152.5										
(H×W×D)	4-pole		280×327×152.5										
Weight (kg)	3-pole		13										
	4-pole		16.8										

Overview

Classification	N type	A type	P type	S type
Externals				
Current protection	• L / S / I / G / Thermal	• L / S / I / G / Thermal • ZSI(Protective coordination)	• L / S / I / G / Thermal(Continuous) • ZSI(Protective coordination)	• P type
Other protection	-	• Earth leakage (Option)	• Earth leakage(Option) • Over/Under current • Over/Under frequency • Unbalance(Voltage/Current) • Reverse power	• P type
Measurement function	-	• Current (R / S / T / N)	• 3 Phase Voltage/Current RMS/Vector • Power(P, Q, S), PF(3-Phase) • Energy(Positive/Negative) • Frequency, Demand	• 3 Phase Voltage/Current RMS/Vector • Power(P, Q, S), PF(3-Phase) • Energy(Positive/Negative) • Frequency, Demand • Voltage/Current harmonics (1st-63th) • 3 Phase Waveforms • THD, TDD, K-Factor
Fine adjustment	-	-	• Fine adjustment for long/short time delay/instantaneous/ ground	• P type
Pre Trip Alarm	-	-	• Overload protection relays : DO (Alarm) (Ground fault is not available when using Pre trip alarm)	• P type
Digital Output	-	• 3DO (Fixed) • L, S/I, G Alarm	• 3DO (Programmable) • Trip, Alarm, General	• P type
IDMTL setting	-	-	• Compliance with IEC60255-3 SIT, VIT, EIT, DT	• P type
Communication	-	• Modbus/RS-485 • Profibus-DP	• Modbus / RS-485 • Profibus-DP	• Modbus / RS-485 • Profibus-DP
Power supply	• Self Power - Power source works over 25% of current of In (one pole)	• Self Power - Power source works over 25% of current of In (one pole) - External power source are required for comm. • AC/DC 100~250V • DC 24~60V	• AC/DC 100~250V • DC 24~60V * Basic protection function (L / S / I / G) is still under normal operation without control power.	• AC/DC 100~250V • DC 24~60V * Basic protection function (L / S / I / G) is still under normal operation without control power.
RTC timer	• Available	• Available	• Available	• Available
LED for trip info.	• Long time delay • Short time delay/Instantaneous • Ground fault	• N type	• N type	• N type
Fault recording	-	• 10 records (Fault/Current/Date and Time)	• 256 records (Fault/Current/Date and Time)	• 256 records • Last fault wave recording (3 Phase)
Event recording	-	-	• 256 records(Content, Status, Date)	• P type
Operating button	• Reset button	• Reset, Menu Up/Down, Left/Right, Enter	• A type	• A type

Molded Case Circuit Breakers

Metasol 30AF to 250AF Series

Frame Size (AF)		30	50			60	
Type		S-Type	N-Type	S-Type	H-Type	N-Type	S-Type
Type and Pole	2 pole	ABS32c	ABN52c	ABS52c	ABH52c	ABN62c	ABS62c
	3 pole	ABS33c	ABN53c	ABS53c	ABH53c	ABN63c	ABS63c
	4 pole	ABS34c	ABN54c	ABS54c	ABH54c	ABN64c	ABS64c
Rated current, I _n	(A)	(3, 5, 10) 15, 20, 30	15, 20, 30, 40, 50		15, 20, 30, 40, 50	15, 20, 30, 40, 50, 60	
Rated operational voltage, U _e	AC(V)	690	690	690	690	690	690
	DC(V)	500	500	500	500	500	500
Rated insulation voltage, U _i	(V)	1000	1000	1000	1000	1000	1000
Rated impulse withstand voltage, U _{imp}	(kV)	8	8	8	8	8	8
Rated short-circuit breaking capacity(I _{cu}) kA (Sym), KSC8321, IEC 60947-2							
AC	690V	2.5	2.5	5	10	2.5	5
	480/500V	7.5	7.5	10	35	7.5	10
	415/460V	14 (10)	14	18	50	14	18
	380V	18 (14)	18	22	50	18	22
	220/250V	30 (25)	30	35	100	30	35
DC	500V(3P)	5	5	10	30	5	10
	250V(2P)	5	5	10	30	5	10
Service breaking capacity(%I _{cu}), I _{cs}		100	100	100	100	100	100
Category of use		A	A	A	A	A	A
Endurance (Number of operations)	Mechanical	25,000	25,000	25,000	25,000	25,000	25,000
	Electrical	10,000	10,000	10,000	10,000	10,000	10,000
Type of trip unit							
Thermal-magnetic release		fixed	fixed	fixed	fixed	fixed	fixed
Hydraulic-magnetic release		-	-	-	-	-	-
Magnetic release only without thermal trip							
Earth leakage protection	for 3 pole	▲	▲	▲	▲	▲	▲
Accessories							
Electrical auxiliaries	Auxiliary switch	●	●	●	●	●	●
	Alarm switch	●	●	●	●	●	●
	Shunt trip	●	●	●	●	●	●
	Undervoltage trip	●	●	●	●	●	●
External accessories	Direct rotary handle	●	●	●	●	●	●
	Extended rotary handle	●	●	●	●	●	●
	Terminal shield	●	●	●	●	●	●
	Insulation barrier	●	●	●	●	●	●
	Rear connection	●	●	●	●	●	●
	Pad handle lock	●	●	●	●	●	●
	Plug-in device	●	●	●	●	●	●
Dimensions (mm)	W×H×D (3P)	75×130×60	75×130×60		90×155×60	75×130×60	
Weight(kg)	2 pole	0.5	0.5	0.5	0.7	0.5	0.5
	3 pole	0.7	0.7	0.7	1	0.7	0.7
	4 pole	0.9	0.9	0.9	1.2	0.9	0.9

Note) 1. ● applicable or available
 2. ▲ available as a separate breaker
 3. The I_{cs}(service breaking capacity) of ABN100e, ABL125/250AF are in ()



100		125			250			
N-Type		S-Type	H-Type	L-Type	N-Type	S-Type	H-Type	L-Type
ABN102c	ABN102e	ABS102c	ABH102c	ABL102c	ABN202c	ABS202c	ABH202c	ABL202c
ABN103c	ABN103e	ABS103c	ABH103c	ABL103c	ABN203c	ABS203c	ABH203c	ABL203c
ABN104c	ABN104e	ABS104c	ABH104c	ABL104c	ABN204c	ABS204c	ABH204c	ABL204c
15, 20, 30, 40, 50, 60, 75, 100		15, 20, 30, 40, 50, 60, 75, 100, 125			100, 125, 150, 175, 200, 225, 250			
690		690	690	690	690	690	690	690
500		500	500	500	500	500	500	500
1000		1000	1000	1000	1000	1000	1000	1000
8		8	8	8	8	8	8	8
5	7.5 (5)	8	10	10 (10)	8	8	10	10 (10)
10	14 (10)	25	35	35 (35)	18	26	35	35 (35)
18	31 (18)	37	50	60 (50)	26	37	50	60 (50)
22	31 (22)	42	50	60 (50)	30	42	50	60 (50)
35	50 (35)	85	100	100 (100)	65	85	100	100 (100)
10	15 (10)	20	30	30 (30)	10	20	30	30 (30)
10	15 (10)	20	30	30 (30)	10	20	30	30 (30)
100	()	100	100	()	100	100	100	()
A	A	A	A	A	A	A	A	A
25,000	25,000	25,000	25,000	25,000	25,000	25,000	25,000	25,000
10,000	10,000	10,000	10,000	10,000	5,000	5,000	5,000	5,000
fixed	fixed	fixed	fixed	fixed	fixed	fixed	fixed	fixed
-	-	-	-	-	-	-	-	-
▲	▲	▲	▲	▲	▲	▲	▲	▲
●	●	●	●	●	●	●	●	●
●	●	●	●	●	●	●	●	●
●	●	●	●	●	●	●	●	●
●	●	●	●	●	●	●	●	●
●	●	●	●	●	●	●	●	●
●	●	●	●	●	●	●	●	●
●	●	●	●	●	●	●	●	●
●	●	●	●	●	●	●	●	●
●	●	●	●	●	●	●	●	●
●	●	●	●	●	●	●	●	●
●	●	●	●	●	●	●	●	●
●	●	●	●	●	●	●	●	●
●	●	●	●	●	●	●	●	●
75×130×60		90×155×60			105×165×60			
0.5	0.5	0.7	0.7	0.7	1.1	1.1	1.1	1.1
0.7	0.7	1	1	1	1.2	1.2	1.2	1.2
0.9	0.9	1.2	1.2	1.2	1.6	1.6	1.6	1.6

Calibrated for 40°C	Amb. Temp.	-5°C	0°C	10°C	20°C	25°C	30°C	35°C	40°C	45°C	50°C
	In=15 to 30	111.9%	111.3%	110.0%	108.0%	106.6%	104.9%	102.7%	100.0%	96.8%	93.3%
	In=40 to 100	110.2%	109.8%	108.7%	107.0%	105.8%	104.3%	102.4%	100.0%	97.2%	94.0%
	In=100 to 225	114.3%	113.2%	110.6%	107.5%	105.8%	104.0%	102.0%	100.0%	97.9%	95.6%
In=250 to 800	110.0%	109.0%	107.0%	105.0%	104.0%	103.0%	101.5%	100.0%	98.5%	97.0%	

Molded Case Circuit Breakers

Metasol 400AF to 1200AF Series

Frame Size (AF)		400			
Type		N-Type	S-Type	H-Type	L-Type
Type and Pole	2 pole	ABN402c	ABS402c	ABH402c	ABL402c
	3 pole	ABN403c	ABS403c	ABH403c	ABL403c
	4 pole	ABN404c	ABS404c	ABH404c	ABL404c
Rated current, I _n	(A)	250, 300, 350, 400			
Rated operational voltage, U _e	AC(V)	690	690	690	690
	DC(V)	500	500	500	500
Rated insulation voltage, U _i	(V)	1000	1000	1000	1000
Rated impulse withstand voltage, U _{imp}	(kV)	8	8	8	8
Rated short-circuit breaking capacity(I _{cu}) kA (Sym), KSC8321, IEC 60947-2					
AC	690V	5	8	10	14
	480/500V	18	35	50	65
	415/460V	37	50	65	85
	380V	42	65	70	100
	220/250V	50	75	85	125
DC	500V(3P)	10	20	40	40
	250V(2P)	10	20	40	40
Service breaking capacity(%I _{cu}), I _{cs}		100	100	100	75
Category of use		A	A	A	A
Endurance (Number of operations)	Mechanical	4,000	4,000	4,000	4,000
	Electrical	1,000	1,000	1,000	1,000
Type of trip unit					
Thermal-magnetic release		fixed	fixed	fixed	fixed
Hydraulic-magnetic release		-	-	-	-
Magnetic release only without thermal trip		-	-	-	-
Earth leakage protection	for 3 pole	▲	▲	▲	▲
Accessories					
Electrical auxiliaries	Auxiliary switch	●	●	●	●
	Alarm switch	●	●	●	●
	Shunt trip	●	●	●	●
	Undervoltage trip	●	●	●	●
External accessories	Direct rotary handle	●	●	●	●
	Extended rotary handle	●	●	●	●
	Terminal shield	●	●	●	●
	Insulation barrier	●	●	●	●
	Rear connection	●	●	●	●
	Mechanical interlock	●	●	●	●
	Plug-in device	●	●	●	●
Dimensions (mm)	W×H×D (3P)	140×257×109			
Weight(kg)	2 pole	5.2	5.2	5.2	5.2
	3 pole	6.2	6.2	6.2	6.2
	4 pole	7.8	7.8	7.8	7.8

Note) 1. ● applicable or available
2. ▲ available as a separate breaker



	800			1000		1200		
	N-Type	S-Type	L-Type	S-Type	L-Type	S-Type		L-Type
	ABN802c	ABS802c	ABL802c	-	-	-	-	-
	ABN803c	ABS803c	ABL803c	ABS1003b	ABL1003b	ABS1203b	ABS1203bE	ABL1203b
	ABN804c	ABS804c	ABL804c	ABS1004b	ABL1004b	ABS1204b	-	ABL1204b
	500, 630, 700, 800			1000		1200		
	690	690	690	600	600	600	600	600
	500	500	500	-	-	-	-	-
	1000	1000	1000	690	690	690	690	690
	8	8	8	6	6	6	6	6
	8	10	14	-	-	-	-	-
	25	45	65	50	75	50	50	75
	37	65	85	65	85	65	65	85
	45	75	100	65	85	65	65	85
	50	85	125	100	125	100	100	125
	10	20	40	-	-	-	-	-
	10	20	40	-	-	-	-	-
	100	100	75	50	50	50	50	50
	A	A	A	A	A	A	A	A
	2,500	2,500	2,500	2,500	2,500	2,500	2,500	2,500
	500	500	500	500	500	500	500	500
	fixed	fixed	fixed	fixed	fixed	fixed	-	fixed
	-	-	-	-	-	-	Adjustable	-
	-	-	-	-	-	-	-	-
	▲	▲	▲	-	-	-	●	-
	●	●	●	●	●	●	●	●
	●	●	●	●	●	●	●	●
	●	●	●	●	●	●	●	●
	●	●	●	●	●	●	●	●
	●	●	●	-	-	-	-	-
	●	●	●	-	-	-	-	-
	●	●	●	-	-	-	-	-
	●	●	●	●	●	●	●	●
	●	●	●	●	●	●	●	●
	●	●	●	-	-	-	-	-
	●	●	●	-	-	-	-	-
	210×280×109			220×400×105		220×400×105		
	11	11	11	-	-	-	-	-
	11.5	11.5	11.5	19.6	19.6	-	-	-
	18.2	18.2	18.2	-	-	25.7	25.7	25.7

Calibrated for 40°C	Amb. Temp.	-5°C	0°C	10°C	20°C	25°C	30°C	35°C	40°C	45°C	50°C
	In=15 to 30	111.9%	111.3%	110.0%	108.0%	106.6%	104.9%	102.7%	100.0%	96.8%	93.3%
	In=40 to 100	110.2%	109.8%	108.7%	107.0%	105.8%	104.3%	102.4%	100.0%	97.2%	94.0%
	In=100 to 225	114.3%	113.2%	110.6%	107.5%	105.8%	104.0%	102.0%	100.0%	97.9%	95.6%
	In=250 to 800	110.0%	109.0%	107.0%	105.0%	104.0%	103.0%	101.5%	100.0%	98.5%	97.0%

Earth Leakage Circuit Breakers

Metasol 30AF to 250AF Series

Frame Size (AF)			30	50		
Type			S-Type	N-Type	S-Type	H-Type
Type and pole	2-pole		EBS32c	EBN52c	-	-
	3-pole		EBS33c	EBN53c	EBS53c	EBH53c
	4-pole		EBS34c	-	EBS54c	EBH54c
Protective function			Overload, Short-circuit and ground fault	Overload, Short-circuit and ground fault	Overload, Short-circuit and ground fault	Overload, Short-circuit and ground fault
Rated current, I _n	(A)		(5, 10) ^{Note 2} , 15, 20, 30	15, 20, 30, 40, 50	15, 20, 30, 40, 50	
Rated impulse withstand voltage, U _{imp}	(kV)		6	6	6	
Instantaneous type	Rated residual current, I _{Δn}	(mA)	30, 100, 100/200/500 100/300/500	30, 100, 100/200/500, 100/300/500	30, 100, 100/200/500 100/300/500	
	Residual current off-time at I _{Δn}	sec	≤ 0.1	≤ 0.1	≤ 0.1	
	Rated operational voltage, U _e	AC (V)	220/460	220/460	220/460	
Time delay type	Rated residual current	1A	0.1/0.2/0.5/1	0.1/0.2/0.5/1	0.1/0.2/0.5/1	
	Intentional time delay	1s	0/0.2/0.5/1	0/0.2/0.5/1	0/0.2/0.5/1	
	Rated residual current	2A	0.1/0.4/1/2	0.1/0.4/1/2	0.1/0.4/1/2	
	Intentional time delay	2s	0.5/1/1.5/2	0.5/1/1.5/2	0.5/1/1.5/2	
Rated short-circuit breaking capacity (I _{cu}) kA (Sym), KSC8321, IEC 60947-2						
AC	460V		14 (10)	14	18	50
	415V		14 (10)	14	18	50
	220/250V		30 (25)	30	35	100
Service breaking capacity(%I _{cu}), I _{cs}			100	100	100	100
Category of use			A	A	A	A
Endurance	Mechanical		25,000	25,000	25,000	25,000
(Number of operations)	Electrical		10,000	10,000	10,000	10,000
Type of trip unit						
Overcurrent pick-up			Thermal-magnetic	Thermal-magnetic		
Earth leakage pick-up			Electronic	Electronic		
Accessories						
Electrical auxiliaries	Auxiliary switch		●	●	●	●
	Alarm switch		●	●	●	●
External accessories	Insulation barrier		●	●	●	●
	Terminal cover (Long)		●	●	●	●
	Terminal cover (Short)		●	●	●	●
	Rotary handle (Direct)		●	●	●	●
	Rotary handle (Direct, Key lock)		●	●	●	●
	Rotary handle (Extended)		●	●	●	●
	Rear terminal (Bar)					●
	Rear terminal (Round)		●	●	●	●
	Pad handle lock		●	●	●	●
	Dimensions (mm)	W×H×D (3P)		75×130×60	75×130×60	
Weight(kg)	2 pole		-	0.5	-	-
	3 pole		0.7	0.7	0.7	1
	4 pole		0.9	-	0.9	1.2

Note) 1. ● applicable or available

2. The short-circuit breaking capacities in () are applied to the rated current in (5, 10A)

Earth Leakage Circuit Breakers

Metasol 400AF to 1200AF Series

Frame Size (AF)			400			
Type			N-Type	S-Type	H-Type	L-Type
Type and pole	3-pole		EBN403c	EBS403c	EBH403c	EBL403c
	4-pole		EBN404c	EBS404c	EBH404c	EBL404c
Protective function			Overload, Short-circuit and ground fault			
Rated current, I _n	(A)		250, 300, 350, 400			
Rated impulse withstand voltage, U _{imp}	(kV)		6			
Rated operational voltage, U _e	AC (V)		220/460			
Instantaneous type	Rated residual current, I _{Δn}	(mA)	30, 100/200/500			
	Residual current off-time at I _{Δn}	sec	≤ 0.1	≤ 0.1	≤ 0.1	≤ 0.1
Time delay type	Rated residual current	A	0.1/0.4/1/2	0.1/0.4/1/2	0.1/0.4/1/2	0.1/0.4/1/2
	Intentional time delay	s	0.5/1/1.5/2	0.5/1/1.5/2	0.5/1/1.5/2	0.5/1/1.5/2
Rated short-circuit breaking capacity (I _{cu}) kA (Sym), KSC8321, IEC 60947-2						
AC	415/460V		37	50	65	85
	220/250V		50	75	85	125
Service breaking capacity(%I _{cu}), I _{cs}			100	100	100	100
Category of use			A	A	A	A
Endurance (Number of operations)	Mechanical		4,000	4,000	4,000	4,000
	Electrical		1,000	1,000	1,000	1,000
Type of trip unit						
Overcurrent pick-up			Thermal-magnetic			
Earth leakage pick-up			Electronic			
Accessories						
Electrical auxiliaries	Auxiliary switch		●	●	●	●
	Alarm switch		●	●	●	●
	Shunt trip		●	●	●	●
	Undervoltage trip		●	●	●	●
External accessories	Insulation barrier		●	●	●	●
	Terminal cover (Long) - 2, 3 pole		●	●	●	●
	Terminal cover (Long) - 4 pole		●	●	●	●
	Rotary handle (Direct)		●	●	●	●
	Rotary handle (Extended)		●	●	●	●
	Mechanical interlock - 2, 3 pole		●	●	●	●
	Mechanical interlock - 4 pole		●	●	●	●
	Rear terminal - 2 pole		●	●	●	●
	Rear terminal - 3 pole		●	●	●	●
	Rear terminal - 4 pole		●	●	●	●
Dimensions (mm)	W×H×D (3P)		140×257×109			
Weight(kg)	3 pole		7	7	7	7
	4 pole		8.4	8.4	7	7

Note) 1. ● applicable or available

Air Circuit Breakers

Susol ACB Series

Circuit Breaker



Frame			AH-D					
Type			AH-06D	AH-08D	AH-10D	AH-13D	AH-16D	AH-20D
Ampere frame	(AF)		630	800	1000	1250	1600	2000
Rated current (A)	(In max)	at 40°C	200	400				
			400	630	1000	1250	1600	2000
			630	800				
Setting current (A)	Control trip relay (... × In max)		(0.4 ~ 1.0) × In max					
Rated current of neutral pole (A)			400	400	1000	1250	1600	2000
			630	800				
Rated insulation voltage (V)	(Ui)		1,000					
Rated operational voltage (V)	(Ue)		690					
Rated impulse withstand voltage (kV)	(Uimp)		12					
Frequency (Hz)			50/60					
Number of poles (P)			3/4					
Rated breaking capacity (kA sym)			85					
AC 50/60Hz	(Icu)	IEC 60947-2 KS C 4620	220V/230V/380V/415V 460V/480V/500V 550V/600V/690V			85 85 65		
Rated service breaking capacity (kA)	(Ics)		... % × Icu			100%		
Rated making capacity (kA peak)			187					
AC 50/60Hz	(Icm)	IEC 60947-2 KS C 4620	220V/230V/380V/415V 460V/480V/500V 550V/600V/690V			187 187 143		
Rated short-time withstand current (kA)	(Icw)		1 sec 2 sec 3 sec			65 60 50		
Operating time (ms)			Maximum total breaking time			40		
			Maximum closing time			80		
Life cycle (time)	Mechanical		20,000					
	Electrical		5,000					
Connections	Draw-out / Fixed		Horizontal connection			●		
			Vertical connection			○		
			Front connection			○		
			Mixed connection			○		
Weight (kg)	Draw-out type	Main body	Motor charging type			63/74		
(3P/4P)		(With cradle)	Manual charging type			70/85		
		Cradle only				61/72		
	Fixed type		Motor charging type			29/32		
			Manual charging type			33/40		
						34/44		
						38/47		
External dimensions (mm)		Draw-out	3P			430×334×375		
(H×W×D)		type	4P			430×419×375		
		Fixed type	3P			300×300×295		
			4P			300×385×295		
Trip relay			N, A, P, S type					
Certificate & Approval			KS / KEMA / KERI / GOST / CCC					
Marine classification			LR, ABS, DNV, KR, BV, GL, RINA, NK					

- Note) 1. Life time means not guarantee, but limitation.
 Quality guarantee: On/Off frequency on the basis of IEC60947-2 within the term of guarantee
 2. In case of Marine ACB, please contact us.
 3. The use of AH-D in IT systems is limited to 500 V network voltage.
 4. AH-20D, AH-40E types are equipped with vertical-only terminals.



AH-E								
AH-06E	AH-08E	AH-10E	AH-13E	AH-16E	AH-20E	AH-25E	AH-32E	AH-40E
630	800	1000	1250	1600	2000	2500	3200	4000
630	800	1000	1250	1600	2000	2500	3200	4000
(0.4 ~ 1.0) × In max								
630	800	1000	1250	1600	2000	2500	3200	4000
1,000								
690								
12								
50/60								
3/4								
100								
100								
85								
100%								
220								
220								
187								
85								
75								
65								
40								
80								
15,000								
5,000								
●								-
○								●
○								-
○								-
87/103							107/139	
85/101							102/145	
44/55							65/85	
44/55							61/81	
42/53							60/80	
430×412×375								
430×527×375								
300×378×295								
300×493×295								
N, A, P, S type								
KS / KEMA / KERI / GOST / CCC								
LR, ABS, DNV, KR, BV, GL, RINA, NK								

AH-G		
AH-40G	AH-50G	AH-63G
4000	5000	6300
4000	5000	6300
(0.4 ~ 1.0) × In max		
4000	5000	6300
1,000		
690		
12		
50/60		
3/4		
150		
150		
100		
100%		
330		
330		
220		
100		
85		
75		
40		
80		
10,000		
2,000		
○		
●		
-		
-		
181/223		186/230
179/221		184/228
97/117		102/124
98/123		103/130
96/121		101/128
460×785×375		
460×1015×375		
300×751×295		
300×981×295		
N, A, P, S type		
KS / KEMA / KERI / GOST / CCC		
LR, ABS, DNV, KR, BV, GL, RINA, NK		

※ Derating of the rated current is required according to the ambient temperature around the breaker in a panel if it is higher than the reference value.

Air Circuit Breakers

Susol ACB Series

Switch-Disconnecter



Frame			DH-D					
Type			DH-06D	DH-08D	DH-10D	DH-13D	DH-16D	DH-20D
Ampere frame	(AF)		630	800	1000	1250	1600	2000
Rated current (A)	(In max)	at 40°C	200	400	1000	1250	1600	2000
Setting current (A)	Control trip relay (... × In max)		(0.4 ~ 1.0) × In max					
Rated current of neutral pole (A)			400	400	1000	1250	1600	2000
			630	800				
Rated insulation voltage (V)	(Ui)		1,000					
Rated operational voltage (V)	(Ue)		690					
Rated impulse withstand voltage (kV)	(Uimp)		12					
Frequency (Hz)			50/60					
Number of poles (P)			3/4					
Rated service breaking capacity (kA)	(Ics)	... % × Icu	100%					
Rated making capacity (kA peak)	(Icm)	IEC 60947-3 AC ~ 690 V	143					
Rated short-time withstand current (kA)	(Icw)		65					
		1 sec	60					
		2 sec	50					
Operating time (ms)			40					
	Maximum total breaking time		80					
	Maximum closing time							
Life cycle (time)	Mechanical		20,000					
	Electrical		5,000					
Connections	Draw-out / Fixed	Horizontal connection		●		-		
		Vertical connection		○		●		
		Front connection		○		-		
		Mixed connection		○		-		
Weight (kg) (3P/4P)	Draw-out type	Main body	Motor charging type		63/74		70/85	
		(With cradle)	Manual charging type		61/72		68/83	
		Cradle only			29/32		33/40	
	Fixed type	Motor charging type		34/44		38/47		
		Manual charging type		32/42		36/45		
External dimensions (mm) (H×W×D)		Draw-out type	3P	430×334×375				
			4P	430×419×375				
		Fixed type	3P	300×300×295				
			4P	300×385×295				
Trip relay			N, A, P, S type					

Note) 1. Life time means not guarantee, but limitation.

Quality guarantee: On/Off frequency on the basis of IEC60947-3 within the term of guarantee

2. In case of Marine ACB, please contact us.

3. DH-20D, DH-40E types are equipped with vertical-only terminals.



DH-E								
DH-06E	DH-08E	DH-10E	DH-13E	DH-16E	DH-20E	DH-25E	DH-32E	DH-40E
630	800	1000	1250	1600	2000	2500	3200	4000
630	800	1000	1250	1600	2000	2500	3200	4000
(0.4 ~ 1.0) × In max								
630	800	1000	1250	1600	2000	2500	3200	4000
1,000								
690								
12								
50/60								
3/4								
100%								
187								
85								
78								
65								
40								
80								
15,000								
5,000								
●								
○								
○								
○								
87/103								
107/139								
85/101								
102/145								
44/55								
65/85								
44/55								
61/81								
42/53								
60/80								
430×412×375								
430×527×375								
300×378×295								
300×493×295								
N, A, P, S type								

※ Derating of the rated current is required according to the ambient temperature around the breaker in a panel if it is higher than the reference value.

Air Circuit Breakers

Metasol ACB Series

Circuit Breaker



Frame			AN-D				
Type			AN-06D	AN-08D	AN-10D	AN-13D	AN-16D
Ampere frame	(AF)		630	800	1000	1250	1600
Rated current (A)	(In max)	at 40°C	200 400 630	400 630 800	1000	1250	1600
Setting current (A)	Control trip relay (... × In max)		0.4 ~ 1.0				
Rated current of neutral pole (A)			400 630	400 630 800	1000	1250	1600
Rated insulation voltage (V)	(Ui)		1,000				
Rated operational voltage (V)	(Ue)		690				
Rated impulse withstand voltage (kV) (Uimp)			12				
Frequency (Hz)			50/60				
Number of poles (P)			3/4				
Rated breaking capacity (kA sym)			65				
AC 50/60Hz	(Icu)	IEC 60947-2 KS C 4620	220V/230V/380V/415V 460V/480V/500V 550V/600V/690V	65 65 50			
Rated service breaking capacity (kA) (Ics)			... %×Icu	100%			
Rated making capacity (kA peak)			143				
AC 50/60Hz	(Icm)	IEC 60947-2 KS C 4620	220V/230V/380V/415V 460V/480V/500V 550V/600V/690V	143 143 105			
Rated short-time withstand current (kA)	(Icw)		1 sec 2 sec 3 sec	50 42 36			
Operating time (ms)			Maximum total breaking time Maximum closing time	40 80			
Life cycle (time)	Mechanical		20,000				
	Electrical		5,000				
Connections	Draw-out / Fixed		Horizontal connection Vertical connection Front connection Mixed connection	● ○ ○ ○			
Weight (kg) (3P/4P)	Draw-out type	Main body (With cradle) Cradle only	Motor charging type Manual charging type	63/74 61/72 29/32			
	Fixed type		Motor charging type Manual charging type	34/44 32/42			
External dimensions (mm) (H×W×D)		Draw-out type Fixed type	3P 4P 3P 4P	430×334×375 430×419×375 300×300×295 300×385×295			
Trip relay			N, A, P type				
Certificate & Approval			KS / KEMA / KERI / GOST				
Marine classification			-				

- Note) 1. Life time means not guarantee, but limitation.
 Quality guarantee: On/Off frequency on the basis of IEC60947-2 within the term of guarantee
 2. The use of AN-D, AS-D and AS-F in IT systems is limited to 500 V network voltage.
 3. AS-20D, AS-40E types are equipped with vertical-only terminals.



AS-D						AS-E				AS-F		AS-G				
AS-06D	AS-08D	AS-10D	AS-13D	AS-16D	AS-20D	AS-20E	AS-25E	AS-32E	AS-40E	AS-40F	AS-50F	AS-40G	AS-50G	AS-63G		
630	800	1000	1250	1600	2000	2000	2500	3200	4000	4000	5000	4000	5000	6300		
200	400	1000	1250	1600	2000	630, 800	2500	3200	4000	4000	5000	4000	5000	6300		
400	630					1000, 1250									1600, 2000	
630	800					1600, 2000										
0.4 ~ 1.0						0.4 ~ 1.0				0.4 ~ 1.0		0.4 ~ 1.0				
630	800	1000	1250	1600	2000	630, 800	2500	3200	4000	4000	5000	4000	5000	6300		
1,000						1,000				1,000		1,000				
690						690				690		690				
12						12				12		12				
50/60						50/60				50/60		50/60				
3/4						3/4				3/4		3/4				
70						85				100		120				
70						85				100		120				
65						85				85		100				
100%						100%				100%		100%				
154						187				220		264				
154						187				220		264				
143						187				187		220				
65						85				85		100				
50						75				75		85				
42						65				65		75				
40						40				40		40				
80						80				80		80				
20,000						15,000				10,000		10,000				
5,000						5,000				2,000		2,000				
●						●				○		○				
○						○				●		●				
○						○				-		-				
○						○				-		-				
63/74						87/103				104/147		107/139		181/223		186/230
61/72						85/101				102/145		102/145		179/221		184/228
29/32						44/50				58/70		65/85		97/117		102/124
34/44						44/55				63/100		61/81		98/123		103/130
32/42						42/53				61/98		60/80		96/121		101/128
430×334×375						430×412×375				460×629×375		460×785×375				
430×419×375						430×527×375				460×799×375		460×1015×375				
300×300×295						300×378×295				300×597×295		300×751×295				
300×385×295						300×493×295				300×767×295		300×981×295				
N, A, P type						N, A, P type				N, A, P type		N, A, P type				
KS / KEMA / KERI / GOST						KS / KEMA / KERI / GOST				KS / KEMA / KERI / GOST						
LR, ABS, DNV, KR, BV, GL, RINA, NK						LR, ABS, DNV, KR, BV, GL, RINA, NK				LR, ABS, DNV, KR, BV, GL, RINA, NK						

※ Derating of the rated current is required according to the ambient temperature around the breaker in a panel if it is higher than the reference value.

Air Circuit Breakers

Metasol ACB Series

Switch-Disconnecter



Frame			DN-D					
Type			DN-06D	DN-08D	DN-10D	DN-13D	DN-16D	
Ampere frame	(AF)		630	800	1000	1250	1600	
Rated current (A)	(In max)	at 40°C	200 400 630	400 630 800	1000	1250	1600	
Setting current	(A)	Control trip relay (... × In max)	0.4~1.0					
Rated current of neutral pole	(A)		630	800	1000	1250	1600	
Rated insulation voltage (V)	(Ui)		1000					
Rated operational voltage (V)	(Ue)		690					
Rated impulse withstand voltage (kV)	(Uimp)		12					
Frequency (Hz)			50/60					
Number of poles (P)			3/4					
Rated service breaking capacity (kA)	(Ics)	... %×Icu	100%					
Rated making capacity (kA peak)	(Icm)	IEC 60947-3 AC 690V / 600V / 550V	105					
Rated short-time withstand current (kA)	(Icw)	1 sec	50					
		2 sec	42					
		3 sec	36					
Operating time (ms)	Total breaking time		40					
	Closing time		80					
Life cycle (time)	Mechanical		20000					
	Electrical		5000					
Connections	Draw-out type/ Fixed type	Horizontal connection	●	●	●	●	●	
		Vertical connection	○	○	○	○	○	
		Front connection	○	○	○	○	○	
		Mixed connection	○	○	○	○	○	
Weight (kg) (3P/4P)	Draw-out type	Main body (With cradle)	63/74					
		Manual charging type	61/72					
		Cradle only	29/32					
	Fixed type	Motor charging type	34/44					
		Manual charging type	32/42					
External dimensions (mm) (H×W×D)		Draw-out type	3P	430×334×375				
			4P	430×419×375				
		Fixed type	3P	300×300×295				
			4P	300×385×295				

Note) 1. Life time means not guarantee, but limitation.
 Quality guarantee: On/Off frequency on the basis of IEC60947-3 within the term of guarantee
 2. DS-20D, DS-40E types are equipped with vertical-only terminals.



DS-D					
DS-06D	DS-08D	DS-10D	DS-13D	DS-16D	DS-20D
630	800	1000	1250	1600	2000
200	400	1000	1250	1600	2000
400	630				
630	800				
0.4~1.0					
630	800	1000	1250	1600	2000
1000					
690					
12					
50/60					
3/4					
100%					
143					
65					
50					
42					
40					
80					
20000					
5000					
●	●	●	●	●	-
○	○	○	○	○	●
○	○	○	○	○	-
○	○	○	○	○	-
63/74					70/85
61/72					68/83
29/32					33/40
34/44					38/47
32/42					36/45
430×334×375					
430×419×375					
300×300×295					
300×385×295					

DS-E			
DS-20E	DS-25E	DS-32E	DS-40E
2000	2500	3200	4000
630, 800, 1000, 1250, 1600, 2000	2500	1000	1250
0.4~1.0			
630, 800, 1000, 1250, 1600, 2000	2500	3200	4000
1000			
690			
12			
50/60			
3/4			
100%			
187			
85			
75			
65			
40			
80			
15000			
5000			
●	●	●	-
○	○	○	●
○	○	○	-
○	○	○	-
87/103			107/139
85/101			102/145
44/50			65/85
44/55			61/81
42/53			60/80
430×412×375			
430×527×375			
300×378×295			
300×493×295			

※ Derating of the rated current is required according to the ambient temperature around the breaker in a panel if it is higher than the reference value.

Trip relay(OCR)





The trip relay of Susol ACB provides the additional protection functions for voltage, frequency, unbalance, and others in addition to main protection functions for over current, short-circuit, ground fault. It supports the advanced measurement functions for voltage, current, power, electric energy, harmonics, communication function, and others.

Analog trip function interlocked with mechanism enhanced a durability of devices as well as the breaking capacity of ACB.

Zone selective interlocking function makes the protective coordination more simple and thermal memory can be applied to various loads.



Trip relay types

Classification	N type	A type	P type	S type
Externals				
Current protection	• L / S / I / G / Thermal	• L / S / I / G(or EL) • Thermal • ZSI (Protective coordination)	• L / S / I / G(or EL) • Thermal (linear hot start) • ZSI (Protective coordination)	• L / S / I / G(or EL) • Thermal (linear hot start) • ZSI (Protective coordination)
Other protection	-	-	• Over/Under voltage • Over/Under frequency • Unbalance(Voltage/Current) • Reverse power • Reverse power	• Over/Under voltage • Over/Under frequency • Unbalance(Voltage/Current)
Measurement function	-	• Current (R / S / T / N)	• 3 Phase Voltage/Current RMS/Vector • Power(P, Q, S), PF(3-Phase) • Energy(Positive/Negative) • Frequency, Demand	• 3 Phase Voltage/Current RMS/Vector • Power(P, Q, S), PF(3-Phase) • Energy(Positive/Negative) • Frequency, Demand • Voltage/Current harmonics (1st~63th) • 3 Phase Waveforms • THD, TDD, K-Factor
Fine adjustment	-	-	• Fine adjustment for long/short time delay/instantaneous/ground	• Fine adjustment for long/short time delay/instantaneous/ground
Pre Trip Alarm	-	-	• Overload protection relays : DO (Alarm) (Ground fault is not available when using Pre trip alarm)	• Overload protection relays : DO (Alarm) (Ground fault is not available when using Pre trip alarm)
Digital Output	-	• 3DO (Fixed) • L, S/I, G Alarm	• 3DO (Programmable) • Trip, Alarm, General	• 3DO (Programmable) • Trip, Alarm, General
IDMTL setting	-	-	• Compliance with IEC60255-3 SIT, VIT, EIT, DT	• Compliance with IEC60255-3 SIT, VIT, EIT, DT
Communication	-	• Modbus/RS-485 • Profibus-DP	• Modbus / RS-485 • Profibus-DP	• Modbus / RS-485 • Profibus-DP
Power supply	• Self Power - Power source works over 20% of load current.	• Self Power - Power source works over 20% of load current. - External power source are required for comm. • AC/DC 100~250V • DC 15~60V	• AC/DC 100~250V • DC 15~60V * Basic protection function (L / S / I / G) is still under normal operation without control power.	• AC/DC 100~250V • DC 15~60V * Basic protection function (L / S / I / G) is still under normal operation without control power.
RTC timer	-	• Available	• Available	• Available
LED for trip info.	• Long time delay • Short time delay/Instantaneous • Ground fault	• Long time delay • Short time delay/Instantaneous • Ground fault	• Long time delay • Short time delay/Instantaneous • Ground fault	• Long time delay • Short time delay/Instantaneous • Ground fault
Fault recording	-	• 10 records (Fault/Current/Date and Time)	• 256 records (Fault/Current/Date and Time)	• 256 records • Last fault wave form recording (voltage, current are recorded in 3-phase, and can be read only by communication)
Event recording	-	-	• 256 records(Content, Status, Date)	• 256 records(Content, Status, Date)
Operating button	• Reset button	• Reset, Menu Up/Down, Tap, Enter	• Reset, Menu Up/Down, Tap, Enter	• Reset, Menu Up/Down, Tap, Enter

Each OCR type has Battery in itself.

1. Battery lifespan

- 1) When turned off: 14~28years
- 2) When using 1 LED consecutively or turned off: 7~14days

2. The recognizable range of OCR current

- 1) A-Type: When more 15% than rated current(In)
- 2) P/S-Type: When more 12% than rated current(In)

* L/S/I/G(or EL)configuration as standard

(Only. Unable to select ground fault and earth leakage, simultaneously)

LS Final Distribution Boards

LS Final Distribution Boards is fully type-tested by ASTA and specially designed for residential and commercial area for the protection of people and equipment.



شركة أبوظبي للتوزيع
Abu Dhabi Distribution Co.



Full range of Residential & Commercial Distribution System



Features:

- Designed to provide higher level of safety for final distribution board
- Pan assembly type busbar systems to provide easier cabling
- Split neutral bars provide easy connection and maximum cable space
- Easy and safe mounting of LS Miniature Circuit Breaker
- Flush and surface mounted
- Tin plate and cooper busbar
- Galvanized 1.2mm steel sheet



Technical Description

- In compliance with standards : IEC 60439-3
- Short-circuit withstand: 17kA/0.2s
- Peak short time withstand: 35kA
- Index of degree: IP 4X
- Rated operational Voltage(Ue): 415V
- Rated insulation Voltage(Ui): 460V
- Rated Frequency: 50/60Hz
- Rated impuls withstand Voltage(Uimp): 4kV
- Rated Current (In): Upto 125A

Internal view

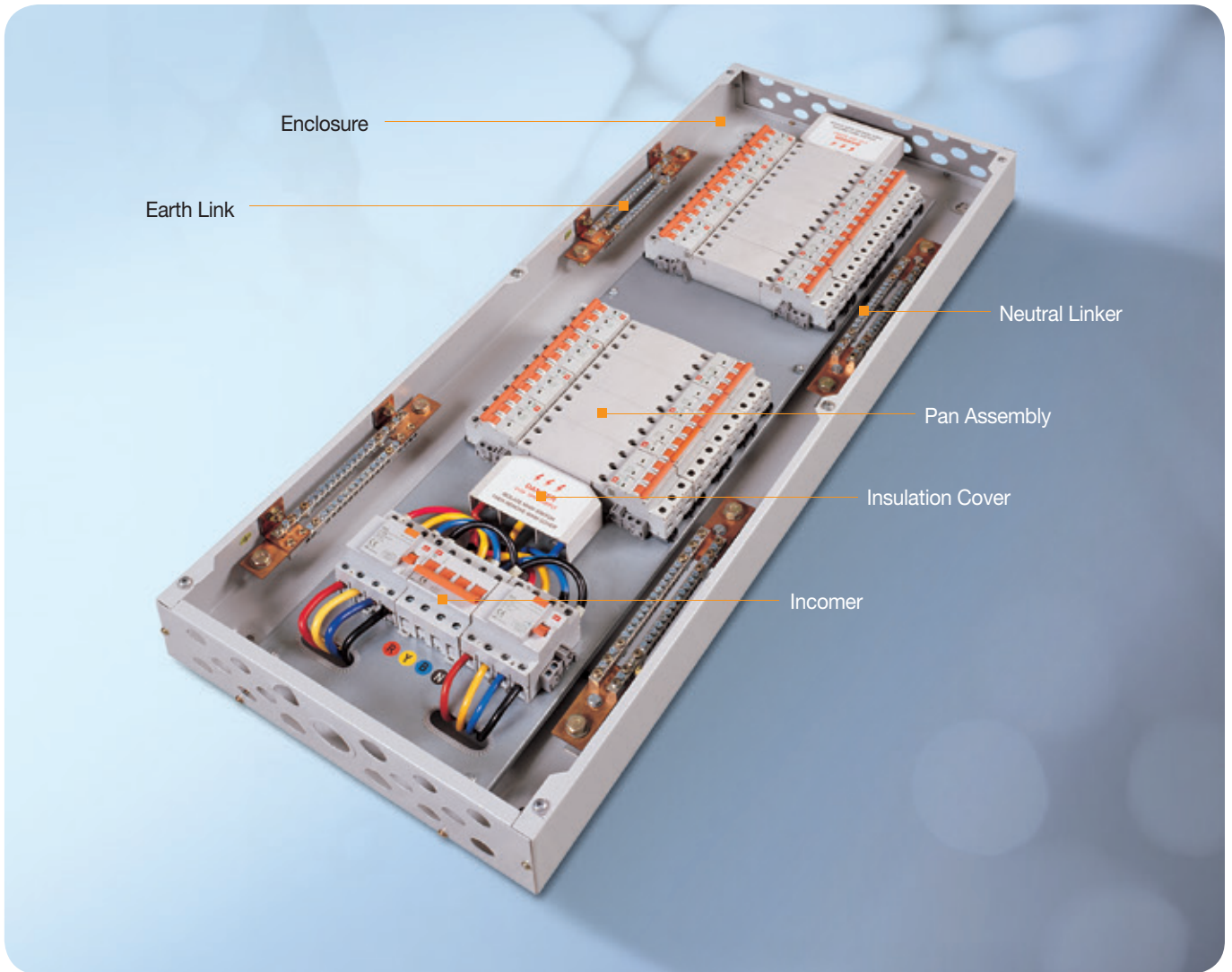

Pan Assembly System



- Rigid and removable pan assembly to provide easier cabling
- Modular panel system
- Flexible connect with CB, RCCB and Disconnect switch

LS Final Distribution Boards

Specific of FDB

Split busbar type

with incoming Isolator feeding two ELCBs

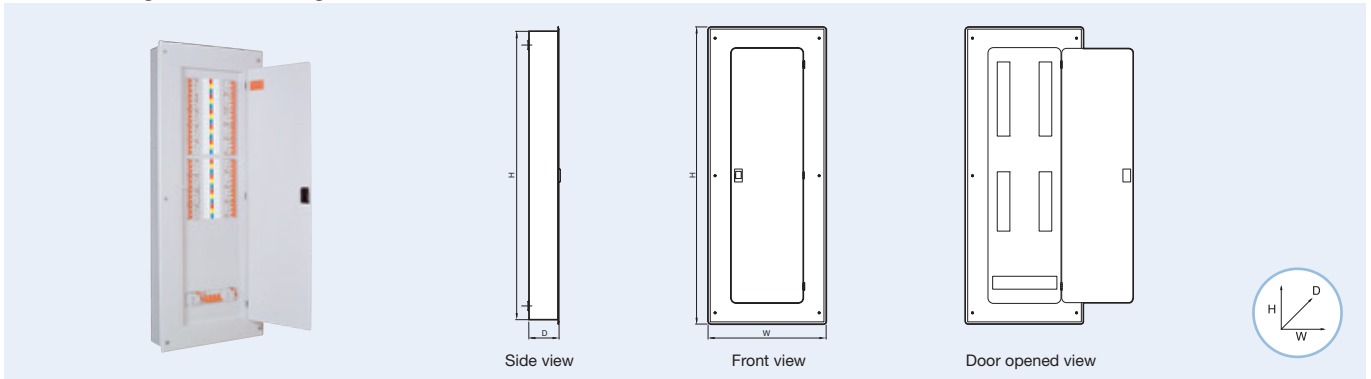

Selection of Enclosure

Code Description	Type	Dimension	
02+02 Way Split DB	Flush	530H×430W×110D mm	
04+02 Way Split DB		580H×430W×110D mm	
04+04 Way Split DB		680H×430W×110D mm	
06+04 Way Split DB		780H×430W×110D mm	
06+06 Way Split DB		780H×430W×110D mm	
08+06 Way Split DB		830H×430W×110D mm	
08+08 Way Split DB		980H×430W×110D mm	
10+08 Way Split DB		980H×430W×110D mm	
12+06 Way Split DB		980H×430W×110D mm	
02+02 Way Split DB		Surface	510H×410W×110D mm
04+02 Way Split DB			560H×410W×110D mm
04+04 Way Split DB			660H×410W×110D mm
06+04 Way Split DB	760H×410W×110D mm		
06+06 Way Split DB	760H×410W×110D mm		
08+06 Way Split DB	810H×410W×110D mm		
08+08 Way Split DB	960H×410W×110D mm		
10+08 Way Split DB	960H×410W×110D mm		
12+06 Way Split DB	960H×410W×110D mm		

Single busbar & Single Incomer type

With Incoming 4P ELCB/MCB/Isolator

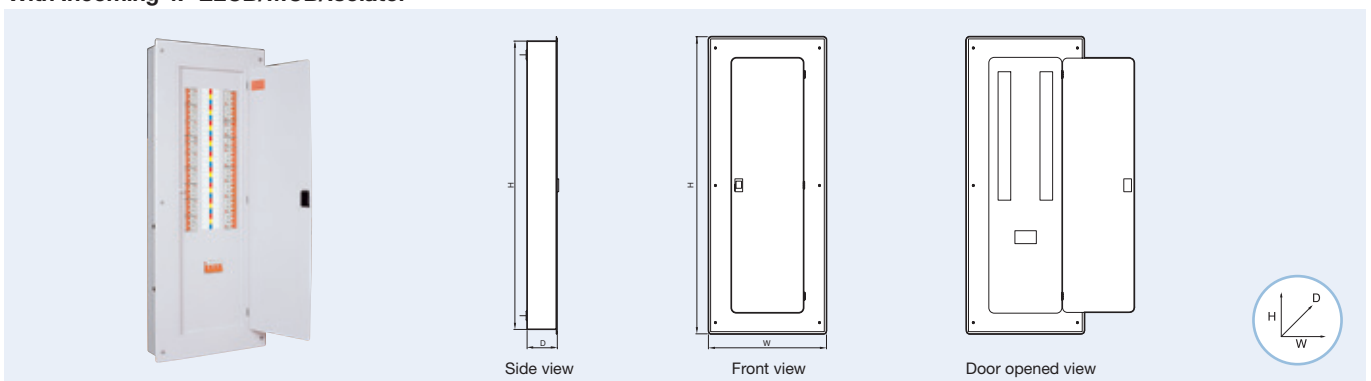

Selection of Enclosure

Code Description	Type	Dimension
4 Way DB 1 INC	Flush	530H×430W×110D mm
6 Way DB 1 INC		580H×430W×110D mm
8 Way DB 1 INC		680H×430W×110D mm
12 Way DB 1 INC		780H×430W×110D mm
14 Way DB 1 INC		830H×430W×110D mm
18 Way DB 1 INC		980H×430W×110D mm
20 Way DB 1 INC		Customized available
24 Way DB 1 INC		Customized available
4 Way DB 1 INC	Surface	510H×410W×110 D mm
6 Way DB 1 INC		560H×410W×110 D mm
8 Way DB 1 INC		660H×410W×110 D mm
12 Way DB 1 INC		760H×410W×110 D mm
14 Way DB 1 INC		810H×410W×110 D mm
18 Way DB 1 INC		960H×410W×110 D mm
20 Way DB 1 INC		Customized available
24 Way DB 1 INC		Customized available

Specific of FDB

Single busbar & Dual Incomer type

With Incoming Isolator & ELCB

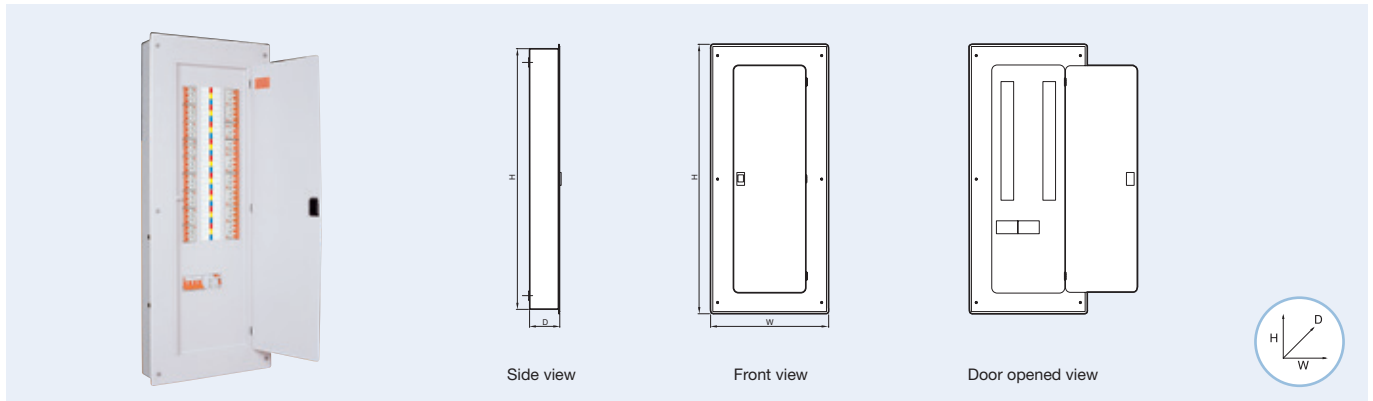

Selection of Enclosure

Code Description	Type	Dimension	
4 Way DB 2 INC	Flush	530H×430W×110D mm	
6 Way DB 2 INC		580H×430W×110D mm	
8 Way DB 2 INC		680H×430W×110D mm	
12 Way DB 2 INC		780H×430W×110D mm	
14 Way DB 2 INC		830H×430W×110D mm	
18 Way DB 2 INC		980H×430W×110D mm	
20 Way DB 2 INC		Customized available	
24 Way DB 2 INC		Customized available	
4 Way DB 2 INC		Surface	510H×410W×110D mm
6 Way DB 2 INC			560H×410W×110D mm
8 Way DB 2 INC	660H×410W×110D mm		
12 Way DB 2 INC	760H×410W×110D mm		
14 Way DB 2 INC	810H×410W×110D mm		
18 Way DB 2 INC	960H×410W×110D mm		
20 Way DB 2 INC	Customized available		
24 Way DB 2 INC	Customized available		

SP&N Consumer Unit

Incoming 2P ELCB / MCB / Isolator

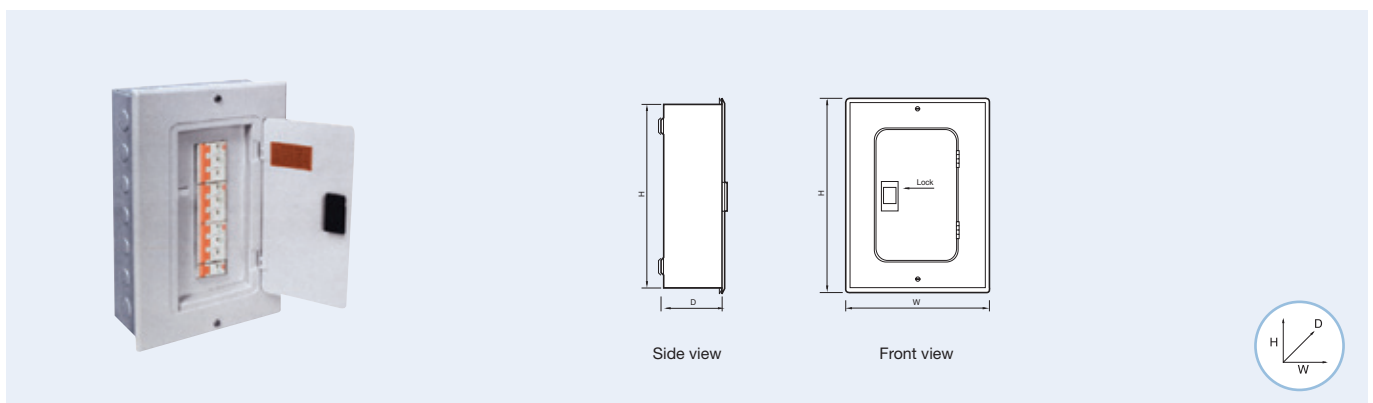

Selection of Enclosure

Code Description	Type	Dimension
6 Way 1P C.Unit		320H×240W×100D mm
9 Way 1P C.Unit		370H×240W×100D mm
12 Way 1P C.Unit		420H×250W×100D mm
15 Way 1P C.Unit		490H×250W×100D mm
18 Way 1P C.Unit		550H×250W×100D mm
22 Way 1P C.Unit		Customized available

LS SMDB Solution

- LS SMDB Solutions are arranged for 3 Phase and neutral incoming supply and specially designed easy to install MCCBs.
- These are fitted with Form 3b and 2 busbar assemblies, tested and ASTA Certified.



شركة أبوظبي للتوزيع
Abu Dhabi Distribution Co.



Rating

- A wide choice of incoming MCCBs make LS SMDB panels flexible to suit most of the requirements and represent excellent value and will appeal to consultants, contractors, end users and OEMs. These are offered in ratings of 125A, 250A, 400A, 630A.
- All incoming and outgoing MCCBs have Thermal/Magnetic fixed and adjustable tripping mechanisms incorporated with a trip-to-test button. These are available in ratings as follows : 16, 20, 25, 32, 40, 50, 63, 80, 100, 125, 160, 250, 400, 630A.

Technical Specifications

Constructional Characteristics

- Complied with IEC 60947-1
- Fully Type Tested, ASTA Certified
- Degree of protection : IP41 as per IEC 60529
- Form of separation: Form 3b
- Enclosure constructed from rigid folded zinc phosphate and protected both internally and externally with polyester powder coating

Electrical Characteristics

- Rated Operational Voltage U_e : upto 690V
- Rated Insulation voltage U_i : upto 750V
- Rated Frequency: 50/60Hz
- Rated Impulse withstand voltage U_{imp} : 8kV
- Rated Short time I_{cw} & peak withstand I_{pk} Current: 36kA/1S

Incoming Devices

MCCB Panelboards

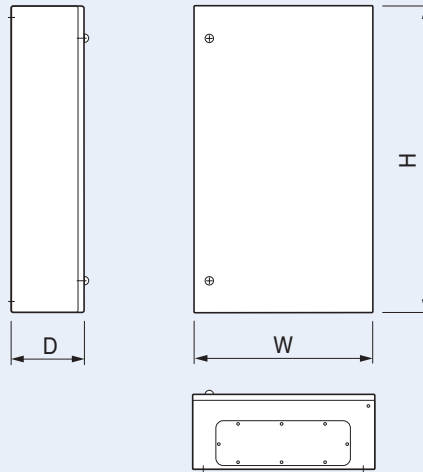

Metasol Series

Incoming Breaker 250 Amps Outgoing Breaker 100 Amps				Incoming Breaker 400 Amps Outgoing Breaker 100 Amps				Incoming Breaker 630 Amps Outgoing Breaker 100 Amps			
No of Ways	Width	Height	Depth	No of Ways	Width	Height	Depth	No of Ways	Width	Height	Depth
2	700	800	180	4	700	1000	250				
4	700	800	180	6	700	1000	250	6	800	1000	250
6	700	800	180	8	700	1200	250	8	800	1200	250
8	700	1000	180	10	700	1400	250	10	800	1400	250
10	700	1200	180	12	700	1400	250	12	800	1400	250
12	700	1200	180	14	700	1600	250	14	800	1600	250

Susol TD/TS Series

Incoming Breaker 250 Amps Outgoing Breaker 100 Amps				Incoming Breaker 400 Amps Outgoing Breaker 100 Amps				Incoming Breaker 630 Amps Outgoing Breaker 100 Amps			
No of Ways	Width	Height	Depth	No of Ways	Width	Height	Depth	No of Ways	Width	Height	Depth
2	700	800	180	4	700	1000	250				
4	700	800	180	6	700	1000	250	6	800	1000	250
6	700	800	180	8	700	1200	250	8	800	1200	250
8	700	1000	180	10	700	1400	250	10	800	1400	250
10	700	1200	180	12	700	1400	250	12	800	1400	250
12	700	1200	180	14	700	1600	250	14	800	1600	250

LS SMDB Solution

Incoming Devices

LS “Susol series” range of MCCBs

Rated current, In	250A 630A								
Rated operational voltage, Ue	750V								
MCCB breaker type	TS250			TS400			TS630		
Ultimate breaking capacity, Icu (kA rms) at 415V	N	H	L	N	H	L	N	H	L
Service breaking capacity, Ics.....% Icu	50	85	150	50	85	150	50	85	150
Protection trip unit	Thermal magnetic / Electronic								
Switch disconnecter type TS	TS250NA			TS400NA			TS630NA		
Short-circuit making capacity Icm (kApeak) (with upstream circuit breaker)	4.9			7.1			8.5		

Incoming application

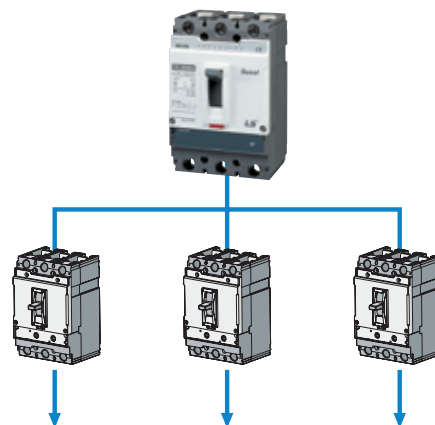

LS “Metasol series” range of MCCBs

Rated current, In	250A 630A		
Rated operational voltage, Ue	690V		
Breaker type	ABS203c	ABS403c	ABS803c
Ultimate breaking capacity, Icu (kA rms) at 415V	37	50	65
Service breaking capacity, Ics.....% Icu	100% Icu	100% Icu	100% Icu
Protection trip unit	Thermal magnetic		

Incoming application

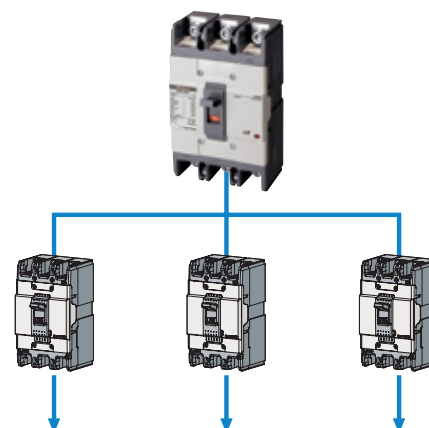

Outgoing devices

LS “Susol series” range of MCCBs

Rated current, I_n	16A 250A					
Rated operational voltage, U_e	upto 750V					
Breaker type	TD100, TD160, TS100, TS160, TS250					
	N		H		L	
No. of poles	1P	3P	1P	3P	1P	3P
Ultimate breaking capacity, I_{cu} (kA rms) at 240V	30	100	50	120	-	200
Service breaking capacity, I_{cs}% I_{cu}	100% I_{cu}					
Protection trip unit	Thermal magnetic / Electronic					

Incoming application

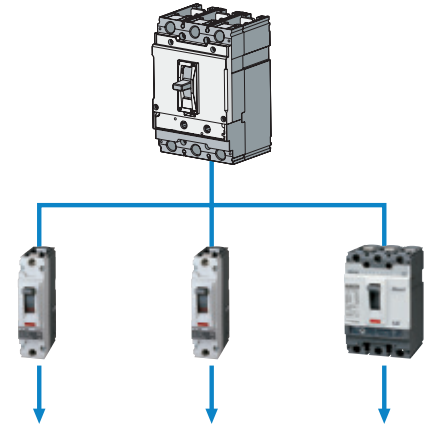

LS “Metasol series” range of MCCBs

Rated current, I_n	15A 100A					
Rated operational voltage, U_e	upto 415V - Single pole upto 690V - Three pole					
Breaker type	ABS103c					
	N		H		L	
No. of poles	2P	3P	2P	3P	2P	3P
Ultimate breaking capacity, I_{cu} (kA rms) at 240V	35		85		100	
Ultimate breaking capacity, I_{cu} (kA rms) at 415V	18		37		50	
Service breaking capacity, I_{cs}% I_{cu}	100% I_{cu}					
Protection trip unit	Thermal magnetic					

Incoming application

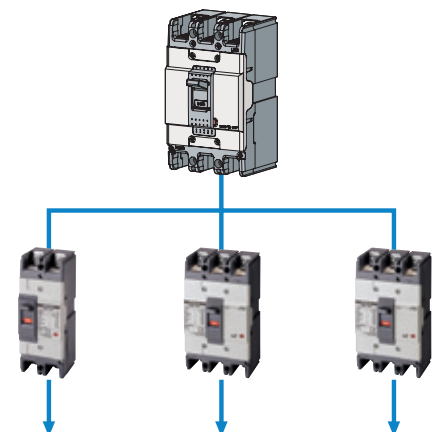

Vacuum Circuit Breakers

Susol VCB Series

VL-06

Type			VL-06□08□04		VL-06□13□06	
Rated voltage	Ur (kV)		7.2			
Rated normal current	Ir (A)		400		630	
Rated frequency	fr (Hz)		50/60			
Rated short-circuit current	Isc (kA)		8		12.5	
Rated short-time withstand current	Ik/tk (kA/s)		8/3		12.5/3	
Rated short-circuit breaking capacity	(MVA)		100		160	
Rated short-circuit making current	Ip (kA)		2.5 × Isc (50Hz)/2.6 × Isc (60Hz)			
Rated breaking time	(cycle)		3			
Rated withstand voltage	Power frequency (1 min)	Ud (kV)	20			
	Impulse (1.2 × 50μs)	Up (kV)	60			
Rated operating sequence			O-0.3s-CO-15s-CO			
Control voltage	Closing coil	(V)	AC/DC 100~130, AC/DC 200~250, DC 125, DC 24~30, DC 48~60, AC 48			
	Trip coil	(V)	AC/DC 100~130, AC/DC 200~250, DC 125, DC 24~30, DC 48~60, AC 48			
Auxiliary contacts			2a2b, 4a4b, 6a6b			
Rated opening time	(sec)		≤ 0.04			
No-load closing time	(sec)		≤ 0.06			
Type test class	Mechanical		M2			
	Electrical		E2 (List1)			
	Capacitive current switching		C2			
Installation version	Fixed		P type			
	Drawout		E, F, G type (for MESG)			
Phase distance	(mm)		130			
Weight	Breaker (E, F, G type)	(kg)	37		37	
	Cradle (E, F, G type)	(kg)	18, 25, 32		19, 26, 33	
Standards			IEC 62271-100, KS C 4611, JEC 2300/JIS C 4603, V-check (KESCO)			

VL-06/12/17

Type			VL-06□20/25□06/13/20			VL-12□20/25□06/13/20			VL-17□20/25□06/13/20		
Rated voltage	Ur (kV)		7.2			12			17.5		
Rated normal current	Ir (A)		630	1250	2000	630	1250	2000	630	1250	2000
Rated frequency	fr (Hz)		50/60								
Rated short-circuit current	Isc (kA)		20, 25								
Rated short-time withstand current	Ik/tk (kA/s)		20/3, 25/3								
Rated short-circuit breaking capacity	(MVA)		250/310			410/520			600/750		
Rated short-circuit making current	Ip (kA)		2.5 × Isc (50Hz)/2.6 × Isc (60Hz)								
Rated breaking time	(cycle)		3								
Rated withstand voltage	Power frequency (1 min)	Ud (kV)	20			28 (42)			38		
	Impulse (1.2 × 50μs)	Up (kV)	60			75 (82)			95		
Rated operating sequence			O-0.3s-CO-15s-CO								
Control voltage	Closing coil	(V)	DC 24~30, DC 48~60, DC 110, DC 125, DC 220~250, AC 48, AC 100~130, AC 220~250								
	Trip coil	(V)	DC 24~30, DC 48~60, DC 110, DC 125, DC 220~250, AC 48, AC 100~130, AC 220~250								
Auxiliary contacts			4a4b, 10a10b								
Rated opening time	(sec)		≤ 0.04								
No-load closing time	(sec)		≤ 0.06								
Type test class	Mechanical		M2								
	Electrical		E2 (List3)								
	Capacitive current switching		C2								
Installation version *	Fixed		P type			P type					
	Drawout		E, F, G type (for MESG), H type (for MCSG)			E, F type (for MESG), H type (for MCSG)					
Phase distance **	(mm)	150			150 (210)			150 (210)			
Weight	Breaker (E, F, G, K type)	(kg)	100	100	130	115 (120)	115 (120)	130 (140)	115 (120)	115 (120)	130 (140)
	Cradle (E, F, G, K type)	(kg)	170	170	180	170 (200)	170 (200)	180 (200)	170 (200)	170 (200)	180 (200)
Standards			IEC 62271-100, KERI/KEMA, V-check (KESCO)								

* H type is a box type cradle with CB compartment style structure.

** () displays option of phase distance.

VL-06/12/17

Type			VL-06□32□06/13/20			VL-12□32□06/13/20/25			VL-17□32□06/13/20/25				
Rated voltage	Ur (kV)		7.2			12			17.5				
Rated normal current	Ir (A)		630	1250	2000	630	1250	2000	2500	630	1250	2000	2500
Rated frequency	fr (Hz)		50/60										
Rated short-circuit current	Isc (kA)		31.5										
Rated short-time withstand current	Ik/tk (kA/s)		31.5/3(4) ^{Note 1)}										
Rated short-circuit breaking capacity	(MVA)		393			655			955				
Rated short-circuit making current	Ip (kA)		2.5×Isc (50Hz)/2.6×Isc (60Hz)										
Rated breaking time	(cycle)		3										
Rated withstand voltage	Power frequency (1 min)	Ud (kV)	20			28 (42) ^{Note 2)}			38				
	Impulse(1.2×50μs)	Up (kV)	60			75			95				
Rated operating sequence			O-0.3s-CO-3min-CO										
Control voltage	Closing coil	(V)	DC 24~30, DC 48~60, DC 110, DC 125, DC 220~250, AC 48, AC 100~130, AC 220~250										
	Trip coil	(V)	DC 24~30, DC 48~60, DC 110, DC 125, DC 220~250, AC 48, AC 100~130, AC 220~250										
Auxiliary contacts			4a4b, 10a10b										
Rated opening time	(sec)		≤ 0.04										
No-load closing time	(sec)		≤ 0.06										
Type test class	Mechanical		M2										
	Electrical		E2 (List 3)										
	Capacitive current switching		C2										
Installation version *	Fixed		Tip P										
	Drawout		H type (for MCSG)	E, F, Fs, G, Gs, K type (for MESSG)	H type (for MCSG)	Gs, K type (for MESSG)	H type (for MCSG)	H type (for MCSG)	H type (for MCSG)				
Phase distance **	(mm)	150			150 (210)			210 (275)	150 (210)			210 (275)	
Weight	Breaker (H type)	(kg)	100	100	130	115/120	115/120	130/140	160/175	115/120	115/120	130/140	160/175
	Cradle (H type)	(kg)	170	170	200	170/200	170/200	170/200	260/290	170/200	170/200	170/200	260/290
	Breaker (P, E, F, G, K type)	(kg)	85	85	100	85/100	85/100	100/115	120/135	85/100	85/100	100/115	120/135
Standards		IEC 62271-100, KERI, V-check (KESCO)											

* H type is a box type cradle with CB compartment style structure. ** () displays option of phase distance.
 Nota 1) For low 4s, please contact us.
 2) Contact us.

VL-20/25

Type			VL-20,25□13□06/13		VL-20,25□16□06/13		VL-20,25□25□06/13/20/25				
Rated voltage	Ur (kV)		24/25.8								
Rated normal current	Ir (A)		630	1250	630	1250	630	1250	2000	2500	
Rated frequency	fr (Hz)		50/60 ^{Note 1)}								
Rated short-circuit current	Isc (kA)		12.5		16		25				
Rated short-time withstand current	Ik/tk (kA/s)		12.5/3 ^{Note 2)}		16/3 ^{Note 2)}		25/3 ^{Note 2)}				
Rated short-circuit breaking capacity	(MVA)		520/560		665/715		1040/1120				
Rated short-circuit making current	Ip (kA)		2.5×Isc (50Hz)/2.6×Isc (60Hz)								
Rated breaking time	(cycle)		3								
Rated withstand voltage	Power frequency (1 min)	Ud (kV)	50/60								
	Impulse(1.2×50μs)	Up (kV)	125								
Rated operating sequence			O-0.3s-CO-3min-CO								
Control voltage	Closing coil	(V)	DC 24~30, DC 48~60, DC 110, DC 125, DC 220~250, AC 48, AC 100~130, AC 220~250								
	Trip coil	(V)	DC 24~30, DC 48~60, DC 110, DC 125, DC 220~250, AC 48, AC 100~130, AC 220~250								
Auxiliary contacts			4a4b, 10a10b								
Rated opening time	(sec)		≤ 0.04								
No-load closing time	(sec)		≤ 0.06								
Type test class	Mechanical		M2								
	Electrical		E2 (List 3)								
	Capacitive current switching		C2								
Installation version *	Fixed		P type								
	Drawout		E, F, G type (for MESSG), K, H type (for MCSG)								H type (for MCSG)
Phase distance **	(mm)	210/265/275								275	
Weight	Breaker (H type)	(kg)	120 (130)		130 (140)		150 (160)				
	Cradle (H type)	(kg)	200 (220)		200 (220)		200 (220)				
	Breaker (P, E, F, G, K, H type)	(kg)	110	115	120		135				
Standards		IEC 62271-100, KERI, V-check (KESCO)									

* H type is a box type cradle with CB compartment style structure. ** () displays option of phase distance.
 Nota 1) 24/25.8kV 25kA 2000A(Phase distance 210mm): 60Hz available only 2) For low 4s, please contact us.

Vacuum Circuit Breakers

Susol VCB Series

VL-36

Type			VH-36□25□06	VH-36□25□13	VH-36□25□20	VH-36□25□25
Rated voltage	Ur (kV)		36			
Rated normal current	Ir (A)		630	1250	2000	2500
Rated frequency	fr (Hz)		50/60			
Rated short-circuit current	Isc (kA)		60			
Rated short-time withstand current	Ik/tk (kA/s)		25/3(4 ^{Note 1)})			
Rated short-circuit breaking capacity	(MVA)		1560			
Rated short-circuit making current	Ip (kA)		62.5/65			
Rated short-circuit making current	(Cycle)		3			
Rated withstand voltage	Power frequency (1 min)	Ud (kV)	70			
	Impulse (1.2 × 50μs)	Up (kV)	170			
Rated operating sequence			O-0.3s-CO-15s-CO			
Control voltage	Closing coil	(V)	DC 24~30, DC 48~60, DC 110, DC 125, DC 220, AC 48, AC 100~130, AC 220~250			
	Trip coil	(V)	DC 24~30, DC 48~60, DC 110, DC 125, DC 220, AC 48, AC 100~130, AC 220~250			
Auxiliary contacts			4a4b, 10a10b			
Rated opening time	(sec)		≤ 0.04			
No-load closing time	(sec)		≤ 0.07			
Type test class	Mechanical		M2			
	Electrical		E2 (List3)			
	Capacitive current switching		C2			
Installation version	Fixed		P type			
	Drawout		H type (for MCSG)			
Phase distance	(mm)		275			
Weight	Breaker (H type)	(kg)	260	260	280	300
	Cradle (H, type)	(kg)	440	440	450	460
Standards			IEC 62271-100			

Note 1) For low 4s, please contact us.

LVB-06/12

Type			VH-06□32□32	VH-06□40□12, 20, 32			VH-12□32□32	VH-12□40□12, 20, 32			
Rated voltage	Ur (kV)		7.2	7.2			12	12			
Rated normal current	Ir (A)		3150 *	1250	2000	3150 *	3150 *	1250	2000	3150 *	
Rated frequency	fr (Hz)		50/60								
Rated short-circuit current	Isc (kA)		31.5	40			31.5	40			
Rated short-time withstand current	Ik/tk (kA/s)		31.5/3	40/3			31.5/3	40/3			
Rated short-circuit breaking capacity	(MVA)		393	499			655	831			
Rated short-circuit making current	Ip (kA)		2.5 × Isc (50Hz)/2.6 × Isc (60Hz)								
Rated short-circuit making current	(Cycle)		3								
Rated withstand voltage	Power frequency (1 min)	Ud (kV)	20			28					
	Impulse (1.2 × 50μs)	Up (kV)	60			75					
Rated operating sequence			O-0.3s-CO-3min-CO								
Control voltage	Closing coil	(V)	DC 48, DC 110, DC 125, DC 220~250, AC 48, AC 110, AC 220								
	Trip coil	(V)	DC 48, DC 110, DC 125, DC 220~250, AC 48, AC 110, AC 220								
Auxiliary contacts			4a4b, 10a10b								
Rated opening time	(sec)		≤ 0.04								
No-load closing time	(sec)		≤ 0.06								
Type test class	Mechanical		M2								
	Electrical		E2 (List1)								
	Capacitive current switching		C2								
Installation version *	Fixed		P type			-					
	Drawout		E,F,G type (for MESH), MCSG Cradle			MCSG Cradle					
Phase distance	(mm)	210	150	210	210	150	210	150	210		
Weight	Breaker (MESH, MCSG type)	(kg)	210, 220	135, 160	135, 160	210, 220	220	164	165	220	
	Cradle (MESH, MCSG type)	(kg)	135, 155	55, 110	63, 117	135, 155	155	110	117	155	
Standards			IEC 62271-100, KERI/KEMA, V-check(KESCO)								

* MCSG style drawable type provide a cradle for building in the switchgear, not a box type for CB compartment. Ordering type is LVB.

Note 1) H type that is a box type cradle for enabling a CB compartment in MCSG is under development. Consult us for ordering.

2) Some LVB is the ordering name of the switchboard for export

VH-06/12/17

Type			VH-06/12□40□13/20				VH-06/12/17□40□13/20					
Rated voltage	Ur (kV)		7.2		12		7.2		12		17.5	
Rated normal current	Ir (A)		1250	2000	1250	2000	1250	2000	1250	2000	1250	2000
Rated frequency	fr (Hz)		50/60									
Rated short-circuit current	Isc (kA)		40									
Rated short-time withstand current	Ik/tk (kA/s)		40/4									
Rated short-circuit breaking capacity	(MVA)		499		831		499		831		1212	
Rated short-circuit making current	Ip (kA)		2.5 × Isc (50Hz)/2.6 × Isc (60Hz)									
Rated short-circuit making current	(Cycle)		3									
Rated withstand voltage	Power frequency (1 min)	Ud (kV)	20		28 (42)		20		28 (42)		38	
	Impulse (1.2 × 50μs)	Up (kV)	60		75		60		75		95	
Rated operating sequence			O-0.3s-CO-3min-CO					O-0.3s-CO-15s-CO				
Control voltage	Closing coil	(V)	DC 48, DC 110, DC 125, DC 220~250, AC 48, AC 110, AC 220									
	Trip coil	(V)	DC 48, DC 110, DC 125, DC 220~250, AC 48, AC 110, AC 220									
Auxiliary contacts			4a4b, 10a10b									
Rated opening time	(sec)		≤ 0.04									
No-load closing time	(sec)		≤ 0.06									
Type test class	Mechanical		M2									
	Electrical		E2 (List3)									
	Capacitive current switching		C2									
Installation version	Drawout		Fs, Gs, K, H type					K, H type				
Phase distance	(mm)		150					210				
Weight	Breaker (H type)	(kg)	165					215				
	Cradle (H, type)	(kg)	205					226				
Standards			IEC 62271-100									

VH-06/12/17

Type			VH-06/12/17□32/40□32						
Rated voltage	Ur (kV)		7.2		12		17.5		
Rated normal current	Ir (A)		3150						
Rated frequency	fr (Hz)		50/60						
Rated short-circuit current	Isc (kA)		31.5/40						
Rated short-time withstand current	Ik/tk (kA/s)		40/4						
Rated short-circuit breaking capacity	(MVA)		393/499		655/831		955/1212		
Rated short-circuit making current	Ip (kA)		2.5 × Isc (50Hz)/2.6 × Isc (60Hz)						
Rated short-circuit making current	(Cycle)		3						
Rated withstand voltage	Power frequency (1 min)	Ud (kV)	20		28 (42)		38		
	Impulse (1.2 × 50μs)	Up (kV)	60		75		95		
Rated operating sequence			O-0.3s-CO-15s-CO						
Control voltage	Closing coil	(V)	DC 48, DC 110, DC 125, DC 220~250, AC 48, AC 110, AC 220						
	Trip coil	(V)	DC 48, DC 110, DC 125, DC 220~250, AC 48, AC 110, AC 220						
Auxiliary contacts			4a4b, 10a10b						
Rated opening time	(sec)		≤ 0.04						
No-load closing time	(sec)		≤ 0.06						
Type test class	Mechanical		M2						
	Electrical		E2 (List3)						
	Capacitive current switching		C2						
Installation version	Drawout		Fs, Gs, K, H type		Gs, K, H type		K, H type	K type	H type
Phase distance	(mm)		210		210		210	254	275
Weight	Breaker (H type)	(kg)	240		240		240	280	280
	Cradle (H, type)	(kg)	235		235		235	250	250
Standards			IEC 62271-100						

Vacuum Circuit Breakers

Susol VCB Series

VH-06/12/17

Type			VH-06□50□13/20/25/32				VH-12□50□13/20/25/32				VH-17□50□13/20/25/32			
Rated voltage	Ur (kV)		7.2				12				17.5			
Rated normal current	Ir (A)		1250	2000	2500	3150	1250	2000	2500	3150	1250	2000	2500	3150
Rated frequency	fr (Hz)		60											
Rated short-circuit current	Isc (kA)		50											
Rated short-time withstand current	Ik/tk (kA/s)		50/3											
Rated short-circuit breaking capacity	(MVA)		623				1039				1515			
Rated short-circuit making current	Ip (kA)		2.6 × Isc (60Hz)											
Rated breaking time	(cycle)		3											
Rated withstand voltage	Power frequency (1 min)	Ud (kV)	20				28 (42) ^{Note)}				38			
	Impulse (1.2 × 50μs)	Up (kV)	60				75 (82) ^{Note)}				95			
Rated operating sequence			O-0.3s-CO-3min-CO											
Control voltage	Closing coil	(V)	DC 48, DC 110, DC 125, DC 220~250, AC 48, AC 110, AC 220											
	Trip coil	(V)	DC 48, DC 110, DC 125, DC 220~250, AC 48, AC 110, AC 220											
Auxiliary contacts			4a4b, 10a10b											
Rated opening time	(sec)		≤ 0.04											
No-load closing time	(sec)		≤ 0.06											
Type test class	Mechanical		M2											
	Electrical		E2 (List3)											
	Capacitive current switching		C2											
Installation version	Fixed		P type											
	Drawout		H type (for MCSG)											
Phase distance	(mm)		210	275		210	275		210	275				
Weight	Breaker (H type)	(kg)	230	287	290	230	287	290	230	287	290			
	Cradle (H, type)	(kg)	175	320	320	175	320	320	175	320	320			
Standards			IEC 62271-100, KERI/KEMA, V-check(KESCO)											

* H type is a box type cradle with CB compartment style structure.
 Note) Contact us.

VH-06/12/17

Type			VH-06/12/17□40□40			VH-06/12/17□50□40		
Rated voltage	Ur (kV)		7.2	12	17.5	7.2	12	17.5
Rated normal current	Ir (A)		4000					
Rated frequency	fr (Hz)		50/60					
Rated short-circuit current	Isc (kA)		40			50		
Rated short-time withstand current	Ik/tk (kA/s)		40/4			50/4		
Rated short-circuit breaking capacity	(MVA)		499	831	1212	624	1040	1515
Rated short-circuit making current	Ip (kA)		104			130		
Rated short-circuit making current	(Cycle)		3					
Rated withstand voltage	Power frequency (1 min)	Ud (kV)	20	28 (42)	38	20	28 (42)	38
	Impulse (1.2 × 50μs)	Up (kV)	60	75	95	60	75	95
Rated operating sequence			O-0.3s-CO-15s-CO					
Control voltage	Closing coil	(V)	DC 48, DC 110, DC 125, DC 220~250, AC 48, AC 110, AC 220					
	Trip coil	(V)	DC 48, DC 110, DC 125, DC 220~250, AC 48, AC 110, AC 220					
Auxiliary contacts			4a4b, 10a10b					
Rated opening time	(sec)		≤ 0.04					
No-load closing time	(sec)		≤ 0.06					
Type test class	Mechanical		M2					
	Electrical		E2 (List3)					
	Capacitive current switching		C2					
Installation version	Fixed		-	-	P type	-	-	P type
	Drawout		H type	H type	H type	H type	H type	H type
Phase distance	(mm)		275					
Weight	Breaker (H type)	(kg)	395					
	Cradle (H, type)	(kg)	200					
Standarde aplicate			IEC 62271-100					

VH-06/12

Type			VH-06H40,50L50	VH-12H40,50L50
Rated voltage	Ur (kV)		7.2	12
Rated normal current	Ir (A)		5000	5000
Rated frequency	fr (Hz)		50/60	
Rated short-circuit current	Isc (kA)		40/50	
Rated short-time withstand current	Ik/tk (kA/s)		50/4	
Rated short-circuit breaking capacity	(MVA)		624	1040
Rated short-circuit making current	Ip (kA)		2.5 × Isc (50Hz)/2.6 × Isc (60Hz)	
Rated breaking time	(Cycle)		3	
Rated withstand voltage	Power frequency (1 min)	Ud (kV)	20	20
	Impulse (1.2 × 50μs)	Up (kV)	60	75
Rated operating sequence			O-0.3s-CO-3min-CO	
Control voltage	Closing coil	(V)	DC 48, DC 110, DC 125, DC 220~250, AC 48, AC 110, AC 220	
	Trip coil	(V)	DC 48, DC 110, DC 125, DC 220~250, AC 48, AC 110, AC 220	
Auxiliary contacts			4a4b, 10a10b	
Rated opening time	(sec)		≤ 0.04	
No-load closing time	(sec)		≤ 0.06	
Type test class	Mechanical		M2	
	Electrical		E2 (List3)	
	Capacitive current switching		C2	
Installation version	Fixed		P type	
	Drawout		H type (for MCSG)	
Phase distance	(mm)		320	
Weight	Breaker (H type)	(kg)	430	
	Cradle (K type)	(kg)	200	
Standards			IEC 62271-100	

VH-20/25

Type			VH-20,25□25□25		VH-20,25□32□13/20/32			VH-20,25□40□13/20/32		
Rated voltage	Ur (kV)		24/25.8							
Rated normal current	Ir (A)		2500	1250	2000	3150	1250	2000	3150	
Rated frequency***	fr (Hz)		50/60		60			50/60		
Rated short-circuit current	Isc (kA)		25		31.5			40		
Rated short-time withstand current	Ik/tk (kA/s)		25/3		31.5/3			40/3		
Rated short-circuit breaking capacity	(MVA)		1039/1117		1309/1407			1662/1787		
Rated short-circuit making current	Ip (kA)		2.6 × Isc (60Hz)							
Rated breaking time	(cycle)		3							
Rated withstand voltage	Power frequency (1 min)	Ud (kV)	50 (65) <small>Note)</small>							
	Impulse (1.2 × 50μs)	Up (kV)	125							
Rated operating sequence****			O-0.3s-CO-3min-CO							
Control voltage	Closing coil	(V)	DC 48, DC 110, DC 125, DC 220~250, AC 48, AC 110, AC 220							
	Trip coil	(V)	DC 48, DC 110, DC 125, DC 220~250, AC 48, AC 110, AC 220							
Auxiliary contacts			4a4b, 10a10b							
Rated opening time	(sec)		≤ 0.04							
No-load closing time	(sec)		≤ 0.06							
Type test class	Mechanical		M2							
	Electrical		E2 (List3)							
	Capacitive current switching		C2							
Installation version*	Fixed		P type							
	Drawout		H type (for MCSG)							
Phase distance**	(mm)	275	210 (275)	210 (275)	275	210 (275)	210 (275)	275		
Weight	Breaker (H type)	(kg)	295	256 (273)	256 (273)	318	256 (273)	256 (273)	318	
	Cradle (H type)	(kg)	316	257 (284)	257 (284)	316	257 (284)	257 (284)	316	
Standards			IEC 62271-100, KERI/KEMA, V-check (KESCO)							

* H type is a box type cradle with CB compartment style structure. ** () displays option of phase distance. *** Rated frequency(fr) 50Hz is certified only to 24kV.
**** Rated operating sequence O-0.3s-CO-15s-CO is certified only to 24kV 40kA.

Note) Contact us.

Vacuum Circuit Breakers



Susol VCB Series

VH-36

Type			VH-36□25□13/20/32			VH-36□32□13/20/32			VH-36□40□13/20/32		
Rated voltage		Ur (kV)	36								
Rated normal current		Ir (A)	1250	2000	3150	1250	2000	3150	1250	2000	3150
Rated frequency		fr (Hz)	50/60								
Rated short-circuit current		Isc (kA)	25			31.5			40		
Rated short-time withstand current		Ik/tk (kA/s)	25/3			31.5/3			40/3		
Rated short-circuit breaking capacity		(MVA)	1559			1964			2494		
Rated short-circuit making current		Ip (kA)	2.5 × Isc (50Hz)/2.6 × Isc (60Hz)								
Rated breaking time		(cycle)	3								
Rated withstand voltage	Power frequency (1 min)	Ud (kV)	70 (95) Note)								
	Impulse (1.2 × 50μs)	Up (kV)	170								
Rated operating sequence			O-0.3s-CO-3min-CO								
Control voltage	Closing coil	(V)	DC 48, DC 110, DC 125, DC 220~250, AC 48, AC 110, AC 220								
	Trip coil	(V)	DC 48, DC 110, DC 125, DC 220~250, AC 48, AC 110, AC 220								
Auxiliary contacts			4a4b, 10a10b								
Rated opening time		(sec)	≤ 0.04								
No-load closing time		(sec)	≤ 0.06								
Type test class	Mechanical		M2								
	Electrical		E2 (List3)								
	Capacitive current switching		C2								
Installation version *	Fixed		P type								
	Drawout		H type (for MCSG)								
Phase distance		(mm)	300								
Weight	Breaker (H type)		400	490	400	490	400	490	400	490	
	Cradle (H type)		700	750	700	750	700	750	700	750	
Standards			IEC 62271-100, KERI/KEMA, V-check (KESCO)								

* H type is a box type cradle with CB compartment style structure.
Note) Contact us.

Accessories

Breakers	Main	Cradle
	<ul style="list-style-type: none"> • Secondary trip coil • Under voltage trip release • Current trip coil • Position S/W • Keylock • Button padlock • Button cover • Mechanical position indicator 	<ul style="list-style-type: none"> • Mechanical position indicator
	<ul style="list-style-type: none"> • Secondary trip coil • Under voltage trip release • Current trip coil • Position S/W • Keylock • Button padlock • Button cover • Plug interlock • Mechanical position indicator 	<ul style="list-style-type: none"> • Earthing S/W • Earthing with electromechanical interlock • Earthing S/W with position S/W • Earthing S/W with keylock • Door interlock • MOC • TOC • Shutter padlock • Emergency mechanical trip device
	<ul style="list-style-type: none"> • Secondary trip coil • Under voltage trip release • Current trip coil • Position S/W • Keylock • Button padlock • Button cover • Plug interlock • Mechanical position indicator 	<ul style="list-style-type: none"> • Earthing S/W • Earthing with electromechanical interlock • Earthing S/W with position S/W • Earthing S/W with keylock • Door interlock • MOC • TOC • Shutter padlock • Emergency mechanical trip device

Various type of Cradle

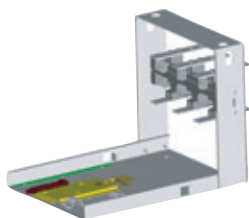

E type

- No Shutter
- For MESG

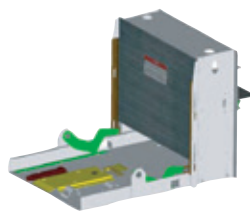

F type

- Insulation Shutter
- For MESG

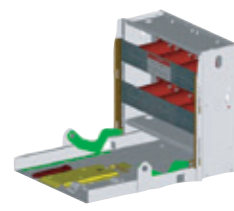

G type

- Bushing
- Insulation Shutter
- For MESG

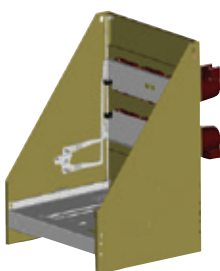

K type

- Bushing
- Closed Compartment structure
- For MCSG



H type

- Bushing
- Metal Insulation Shutter
- Closed Compartment structure
- Earthing Switch & Interlock
- For MCSG
- Door Interlock



Safety Instructions

- For your safety, please read user's manual thoroughly before operating.
- Contact the nearest authorized service facility for examination, repair, or adjustment.
- Please contact qualified service technician when you need maintenance. Do not disassemble or repair by yourself!
- Any maintenance and inspection shall be performed by the personnel having expertise concerned.



- According to The WEEE Directive, please do not discard the device with your household waste.



www.lselectric.co.kr

■ **Headquarter**

127 LS-ro (Hogye-dong) Dongan-gu, Anyang-si, Gyeonggi-Do, 14119, Korea

■ **Seoul Office**

LS Yongsan Tower, 92, Hangang-daero, Yongsan-gu, Seoul, 04386, Korea
Tel. 82-2-2034-4916, 4684, 4429

■ **Overseas Subsidiaries**

- **LS ELECTRIC Japan Co., Ltd. (Tokyo, Japan)**
Tel: 81-3-6268-8241 E-Mail: jschuna@lselectric.biz
- **LS ELECTRIC (Dalian) Co., Ltd. (Dalian, China)**
Tel: 86-411-8730-5872 E-Mail: jiheo@lselectric.com.cn
- **LS ELECTRIC (Wuxi) Co., Ltd. (Wuxi, China)**
Tel: 86-510-6851-6666 E-Mail: jdyim@lselectric.com.cn
- **LS ELECTRIC Vietnam Co., Ltd.**
Tel: 84-93-631-4099 E-Mail: jhchoi4@lselectric.biz (Hanoi)
Tel: 84-24-3823-7890 E-Mail: sjbaik@lselectric.biz (Hochiminh)
- **LS ELECTRIC Middle East FZE (Dubai, U.A.E.)**
Tel: 971-4-886-5360 E-Mail: hschoib@lselectric.biz
- **LS ELECTRIC Europe B.V. (Hoofddorp, Netherlands)**
Tel: 31-20-654-1424 E-Mail: europartner@lselectric.biz
- **LS ELECTRIC America Inc. (Chicago, USA)**
Tel: 1-800-891-2941 E-Mail: sales.us@lselectricamerica.com

■ **Overseas Branches**

- **LS ELECTRIC Tokyo Office (Japan)**
Tel: 81-3-6268-8241 E-Mail: jschuna@lselectric.biz
- **LS ELECTRIC Beijing Office (China)**
Tel: 86-10-5095-1631 E-Mail: chendm@lselectric.com.cn
- **LS ELECTRIC Shanghai Office (China)**
Tel: 86-21-5237-9977 E-Mail: khpaek@lselectric.com.cn
- **LS ELECTRIC Guangzhou Office (China)**
Tel: 86-20-3818-2883 E-Mail: chenxs@lselectric.com.cn
- **LS ELECTRIC Chengdu Office (China)**
Tel: 86-28-8670-3201 E-Mail: yangct@lselectric.com.cn
- **LS ELECTRIC Qingdao Office (China)**
Tel: 86-532-8501-2065 E-Mail: wangzy@lselectric.com.cn
- **LS ELECTRIC Nanjing Office (China)**
Tel: 86-25-8467-0005 E-Mail: ylong@lselectric.com.cn
- **LS ELECTRIC Bangkok Office (Thailand)**
Tel: 66-90-950-9683 E-Mail: sjleet@lselectric.biz
- **LS ELECTRIC Jakarta Office (Indonesia)**
Tel: 62-21-2933-7614 E-Mail: ylee@lselectric.biz
- **LS ELECTRIC Moscow Office (Russia)**
Tel: 7-499-682-6130 E-Mail: jdpark1@lselectric.biz
- **LS ELECTRIC America Western Office (Irvine, USA)**
Tel: 1-949-333-3140 E-Mail: jwyun@lselectricamerica.com



Technical Question or After-sales Service

Customer Center-Quick Responsive Service, Excellent technical support | **82-1644-5481**