

The future starts now



The new digital NZM  
circuit breaker is here.  
Compact • Reliable • Innovative  
Catalog



*Powering Business Worldwide*

# Compact circuit breakers, switch disconnectors

## Content

### System overview

Description, functions and technical data ..... Page 4

1230PIC-785 Symbolphoto



### 1. Compact circuit breakers, switch disconnectors IEC

1.1 Circuit breakers, thermomagnetic releases, 3 pole ..... Page 58  
 1.2 Circuit breakers, magnetic short-circuit releases, 3 pole ..... Page 72  
 1.3 Circuit breakers IEC, electronic releases, 3 pole ..... Page 78  
 1.4 Circuit breakers IEC, electronic releases with energy meter function, 3 pole ..... Page 94  
 1.5 Circuit breakers IEC, thermomagnetic releases, 4 pole ..... Page 108  
 1.6 Circuit breakers IEC, electronic releases, 4 pole ..... Page 118  
 1.7 Circuit breakers IEC, electronic releases with energy meter function, 4 pole ..... Page 132  
 1.8 Compact circuit breakers IEC, thermomagnetic releases, 1 pole ..... Page 140  
 1.9 Switch disconnectors IEC, 3 pole ..... Page 141  
 1.10 Switch disconnectors IEC, 4 pole ..... Page 145

1230PIC-785 Symbolphoto



### 2. Compact circuit breakers, switch disconnectors UL/CSA, IEC

2.1 Circuit breakers UL/CSA, IEC, thermomagnetic releases, 3 pole ..... Page 148  
 2.2 Circuit breakers UL/CSA, IEC, magnetic short-circuit releases, 3 pole ..... Page 158  
 2.3 Circuit breakers UL/CSA, IEC, electronic releases, 3 pole ..... Page 162  
 2.4 Circuit breakers UL/CSA, IEC, electronic releases with energy meter function, 3 pole ..... Page 172  
 2.5 Circuit breakers UL/CSA, IEC, thermomagnetic releases, 4 pole ..... Page 176  
 2.6 Molded case switches for North America ..... Page 178

1230PIC-802 Symbolphoto



### 3. Compact circuit breakers, switch disconnectors IEC, EC, UL/CSA

3.1 Circuit breakers IEC for 1000 V AC, 3 pole ..... Page 180  
 3.2 Switch disconnectors UL/CSA, IEC for 1000 V DC, 1/2 pole ..... Page 181  
 3.3 Switch disconnectors UL/CSA, IEC for 1500 V DC, 1/2 pole ..... Page 182  
 3.4 Circuit breakers IEC for 1500 V AC ..... Page 184  
 3.5 Circuit breakers EC for 500/750 V DC, 1/2 pole ..... Page 187

1230PIC-721 Symbolphoto



### 4. Accessories

4.1 Terminals, NZM1 ..... Page 188  
 4.2 Terminals, NZM2 ..... Page 196  
 4.3 Terminals, NZM3 ..... Page 204  
 4.4 Terminals, NZM4 ..... Page 218  
 4.5 Plug-in units, withdrawable units ..... Page 231  
 4.6 Auxiliary contacts with screw terminals/spring-cage terminal ..... Page 233  
 4.7 Undervoltage releases ..... Page 234  
 4.8 Shunt releases ..... Page 242  
 4.9 Relay modules ..... Page 246  
 4.10 Door coupling rotary handles ..... Page 248  
 4.11 Door coupling rotary handle with key lock ..... Page 251  
 4.12 Door coupling rotary handles for North America ..... Page 252

1230PIC-677 Symbolphoto



## System overview

4.13 Rotary handles	Page 254
4.14 Rotary handles with key lock	Page 255
4.15 Rotary handles with door interlock	Page 256
4.16 Main switch assembly kit	Page 257
4.17 Main switch assembly kit with additional handle	Page 263
4.18 Remote operators	Page 264
4.19 Accessories	Page 266
4.20 Mechanical interlock	Page 269
4.21 Paralleling mechanism	Page 270
4.22 Earth-fault release	Page 271
4.23 Power supply module / Interface module	Page 273
4.24 Communication module	Page 274
4.25 SASY 60i Busbar System	Page 275

## 5. Construction

5.1 Construction size 1: Basic device 1	Page 278
5.2 Construction size 1: Basic device 2	Page 279
5.3 Construction size 1: Basic device 3	Page 280
5.4 Construction size 1: Basic device 4	Page 281

00244478\_0

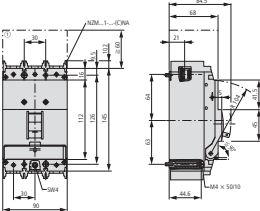

More information	Page 282
------------------	----------



Thinking ahead.  
Shaping the future.



Switch,  
protect  
control,  
measure,  
communicate:



The energy supply and distribution systems of tomorrow have to contend with multiple competing demands. And Eaton has the right products to meet these challenges. Because Eaton, as a global leader in many technology areas, understands what panel building is all about.

For Eaton, future-oriented energy management means: to tackle complex tasks head-on with smart, simple solutions; to develop products that cover a broad range of applications and to provide all markets and sectors with the necessary systems for ensuring a safe, reliable and efficient energy future.

**Eaton's product range leaves nothing to be desired, from the big picture down to the smallest detail:**

- **MODAN** offers globally proven modular switchgears for a wide range of building and industrial applications up to 6,300 A
- With **xEnergy** Eaton is able to offer safety-tested switchgear systems for power distribution systems up to 5,000 A
- Eaton's new **digital NZM circuit breakers** are universally suitable for rated currents from 20 A to 1,600 A; they are now also equipped with the innovative **PXR electronic release** technology



## MODAN modular switchgear

Low-voltage switchgear assemblies up to 6,300 A

MODAN® provides safe, communications-enabled power distribution systems for global markets, which can be easily combined while ensuring maximum availability. Even in the standard version, MODAN systems are renowned for their extreme reliability and safety.

The space-saving design with standardized function modules enables fast planning, handling and commissioning, offering tailor-made solutions for building and industrial applications up to 6,300 A.



## xEnergy Main

Low-voltage power distribution systems up to 5,000 A

The xEnergy switchgear system has been designed to meet demands that are constantly growing: This makes it ideal for building infrastructure up to 5,000 A. Every function block has been carefully and systematically calibrated, from the switchgear and mounting technology to the enclosures and the requisite software. You will not only get safety-tested switchgear that represents the state of the art – you will also save time, money and space.

### **xEnergy combines maximum safety with easy planning:**

- xEnergy fully complies with the IEC 61439 standard.
- To make the planning and assembly of an xEnergy system as easy as possible, we offer our established planning tool, the xEnergy configurator, free of charge.



## The NZM series – circuit breakers up to 1,600 A

Best in class

**Eaton's NZM series circuit breakers cover rated currents of 20 to 1,600 A – with only four frame sizes. And they are also optimally matched to each other. The wide range of possible applications covers every need. Eaton took a close look at what customers really want and designed the product accordingly.**

What stands out, for example, is the comprehensive system of accessories, which can be individually assembled and easily installed in line with specific application requirements. The same goes for the flexible terminals, which offer increased safety for operators thanks to the variety of available covers.

The circuit breakers are thus suitable for universal use – from small distribution boards to machine controls and motor-starter combinations, and all the way to large power distribution systems with a short-circuit breaking capacity of up to 150 kA.







### Full performance, compact design

**The new digital NZM circuit breakers combine full performance with a compact design. The circuit breakers and accessories have been designed in such a way that their function, assembly and handling are the same throughout, in order to make your work as simple as possible.**



Various types of releases are available, including cost-effective versions with bimetallic strips and models with communications-enabled digital electronics, which can take on a variety of protective functions. This makes them suitable for use in both AC and DC networks – from cable protection to the protection of motors, generators and transformers. With switch-disconnectors up to 1,600 A, implementing applications such as main switches, emergency power-off switches and coupler switches is quick and simple.

Despite their slim design, the NZM circuit breakers can handle loads with rated currents up to 1,600 A, and they can safely switch off short-circuit currents up to 150 kA.

The innovative switching technology with double-break contacts helps to speed up the switching process. In the event of a short circuit, the special design and the selected materials will generate repulsive magnetic forces that fling open the contacts in a fraction of a sine wave. Switching capacities up to 150 kA and

operating voltages up to 690 V pose no problem at all. At the same time, thanks to their optimal rate of power loss, the devices have a positive impact on the size of the control panel. The digital NZM circuit breakers are suitable for use in even the toughest environments, such as mining (up to 1,000 V AC), renewable energy (up to 1,500 V DC) and other power-intensive applications with high switching capacities at 690 V AC (e.g. data center, marine and renewable energy applications etc.).



## Circuit breakers offer comprehensive protection: They protect entire systems while offering many additional functions



### 1. The NZM protects systems

as well as cables across all levels, from the main distribution board all the way to the load itself.  
*See page 26*



### 2. The NZM protects motors

as well as motor-starter combinations and input wiring against overloads and short circuits.  
*See page 27*



### 3. The NZM offers full-range protection

and selective protection for many applications.  
*See page 28*



#### 4. The NZM offers earth-fault protection

with integrated alert and trip functions as well as ARMS and ZSI.

See page 28



#### 5. The NZM offers selectivity and backup protection

against excessive short-circuit currents.

See page 29

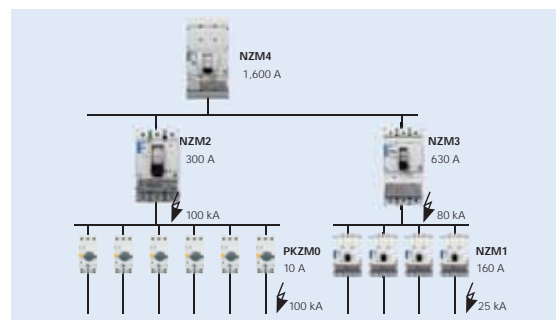

#### 6. The NZM offers zone selectivity and protection against electric arcs

with the patented Arcflash Reduction Maintenance System.

See page 30



### 7. The NZM offers protection against residual currents

for universal mounting, or for mounting directly on the circuit breaker.

*See page 31*



### 8. The NZM protects DC systems

either as a circuit breaker with thermo-magnetic release, or as a switch-disconnector.

*See page 32*



### 9. The NZM protects special applications

with high switching capacities at 690 V AC, at high frequencies, in IT networks, and at 1,000 V AC.

*See page 33*



### 10. The NZM offers protection and ISO 50001

energy metering with Class 1 accuracy in accordance with IEC 61557-12.

See page 36

## Which release provides the right type of protection?

Release	TMTU				PXR10	PXR20			PXR25		
	-A	-AF	-M	-S	-AX	-MX	-VX	-VX...-T	-PX	-PX...-TZ(TAZ)	-PMX
T = Thermomagnetic E = Electronic	T	T	T	T	E	E	E	E	E	E	E
<b>Protective features</b>											
Overload protection	✓	✓	✓	-	✓	✓	✓	✓	✓	✓	✓
Short-time delayed short-circuit protection	-	-	-	-	-	-	✓	✓	✓	✓	-
Non-delayed short-circuit protection	✓	✓	✓	✓	✓	✓	✓	✓	✓	✓	✓
Earth-fault protection	-	-	-	-	-	-	-	✓	-	✓	-
ARMS maintenance mode	-	-	-	-	-	-	-	-	-	✓	-
ZSI zone-selective interlocking	-	-	-	-	-	-	-	-	-	✓	-
<b>Additional functions</b>											
Suitable for DC protection	✓	-	-	-	-	-	-	-	-	-	-
USB interface	-	-	-	-	✓	✓	✓	✓	✓	✓	✓
Current measuring (data readout)	-	-	-	-	-	✓	✓	✓	✓	✓	✓
Comprehensive data collection, including Class 1 energy metering	-	-	-	-	-	-	-	-	✓	✓	✓
Communications-enabled	-	-	-	-	-	✓	✓	✓	✓	✓	✓

## Is a thermo-magnetic or an electronic release the better option?

The right protection for the task at hand

**Thermo-magnetic trip units offer protection against overloads and short circuits. Electronic releases, meanwhile, make it possible to fine-tune the protective effect and to enhance it exponentially. On the one hand, electronic systems trip much more flexibly and precisely thanks to the use of digital electronics. On the other hand, by recording the data digitally, they also open up new possibilities for analytics and predictive maintenance. The most important technical aspects of the two types of releases are explained in detail below.**



### Thermo-magnetic overcurrent releases

Thermo-magnetic releases are the basic release mechanism for protection against overloads and short circuits. This type of release is ideal for cost-effective system designs up to 500 A. It is suitable for use in three-phase networks, AC networks and DC networks as well as for 400 Hz applications.

### Thermal releases

A so-called bimetallic strip is used as the release element in thermally (current-dependent) delayed overload releases. This bimetallic strip is composed of at least two different metals with different coefficients of thermal expansion. The coefficient of thermal or linear expansion indicates the expansion of an object at a temperature increase of 1 K. When a rotor stalls, for example, the motor will draw more current. As a result of this increased current consumption, the current-carrying components of the motor-protective circuit breaker will experience a greater increase in temperature. This means that the metal with the greater coefficient of thermal expansion will expand at a higher rate, causing the bimetallic strip to start bending. This bending results in the release of the internal breaker mechanism, thereby tripping the motor-protective circuit breaker. The circuit breaker's main contacts will then open, which interrupts the supply of power to the motor, so that the corresponding motor fault can be repaired without danger. Once the motor-protective circuit breaker is switched back on, the motor will again start up.



### Magnetic releases

In a circuit breaker, a magnetic overload release performs the short-circuit tripping function. This release works based on the principle of an electromagnet and a current coil. This current coil is not energized by a separate voltage source – instead, the main current flows directly through it. In the event of a short circuit, a large overcurrent will flow through the current coil. The resulting magnetic field will pull the armature into the coil, meaning it will then hit the moving contact piece. This momentum, together with the dynamics of the short-circuit current itself, will cause the contacts to open abruptly, thereby safely disconnecting the short-circuit current. The breaker mechanism will be released simultaneously. As a result, the circuit breaker will remain in the "OFF" position after the short-circuit current has been switched off.



### Ambient temperature compensation

The NZM1 and NZM3 type A releases are not temperature compensated. The NZM2-A and all NZM-M motor-protective releases compensate the ambient temperature by means of an additional bimetallic strip. This compensation significantly reduces the impact of the ambient temperature on the functioning of the thermal release, which in turn improves the current-carrying capacity.

The electronic releases have been equipped with a microprocessor to ensure improved operational continuity.



#### Electronic trip units

The digital electronics are controlled by the microprocessor, making it possible to determine the values of the load current that is being monitored. In contrast to analog electronic systems, the digital electronics will correctly evaluate any harmonics occurring in the network to prevent undesired early tripping. This helps to avoid unnecessary downtime.

Dedicated components simulate a thermal memory even when no current is present and the circuit breaker has tripped due to load overload. This ensures the reliable protection of the connected equipment – even if the cooling-down phase prior to the system restart was too short.

The proper functioning of the electronic components can be checked during protection via a run-in test. Thermocouples ensure the safe tripping of the circuit breaker in the unlikely event that the electronic components overheat.

#### Redundant safety

A parallel mechanical solution ensures maximum safety in the case of very high short-circuit currents, as the hinged armature functions as an additional magnetic release. This release will trip within only a few milliseconds.

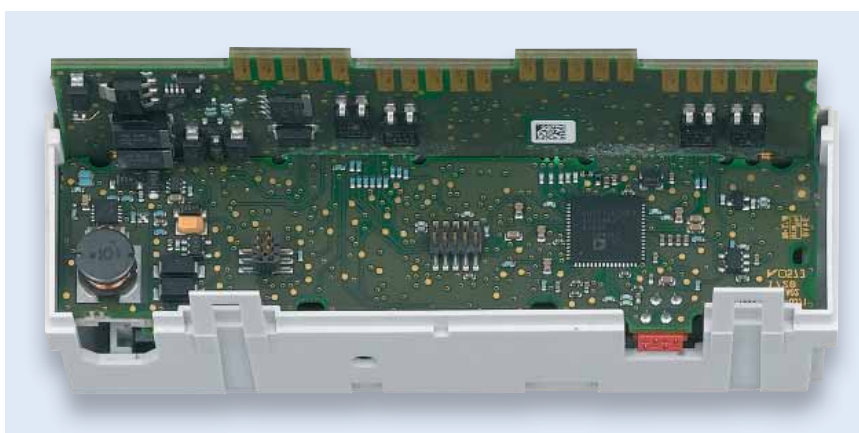



## Power Xpert Release

The next generation of electronic releases – now also available for the NZM



**With the Power Xpert Release (PXR) Eaton has developed a new platform for trip units. This technology has already been integrated in the IZMX series of air circuit breakers, and is now also available for the compact circuit breakers of the NZM series.**

The PXR is a powerful trip unit for professional users. Our customers' greatest possible benefit is always our main priority. Therefore, the PXR combines easy handling across all frame sizes with state of the art technology, a wide range of practical functions and, as always, a proven safety record.

The PXR technology makes it possible to configure and test the circuit breakers from a PC via a USB port. This makes it very easy to access the information generated by the switchgear, to save the test data and to print it. This is the fastest and most convenient way to continuously improve control and maintenance systems. All sensitive data and settings are password-protected to prevent unauthorized access.



### Improved lifecycle management through digital circuit protection

What does lifecycle management mean and what are the benefits for users? Different approaches from Eaton and their advantages and benefits are discussed in this white paper.





Convincing in every way

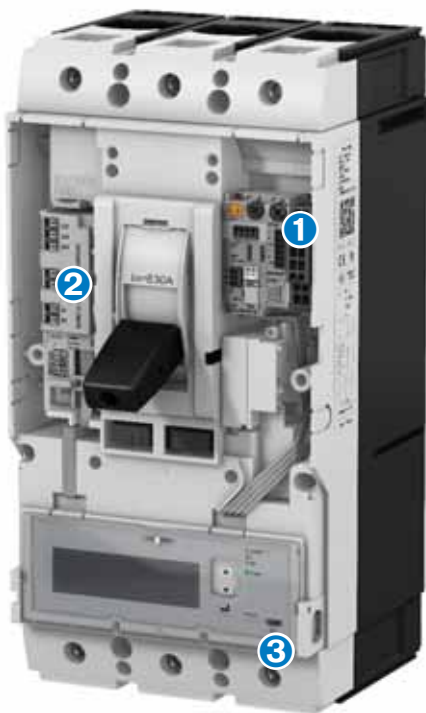

**Saving our users time and offering them the broadest possible range of applications – these were the goals Eaton had in mind while developing the Power Xpert Release platform.**

- ❶ As such, we have equipped the PXR with a consistent design and clear menu navigation that will simplify your day-to-day work. With the PXR, communications are similarly easy: The many available communication modules for various bus systems allow for high-performance connections in line with the respective system requirements. Additionally, the integrated Modbus RTU connection also saves space during installation.

**The new, fully integrated control and measurement technology creates additional benefits for customers**

- ❷ The integrated relays inside the voltage release enable the control of any associated components, alongside the display of operating states (such as alert notifications), the control of remote operators and motor-starter combinations, and much more.
- ❸ The USB interface allows for easy connection to a PC to change the settings, conduct analyses or launch one of the test function.

The Rogowski coil transformer supports ISO 50001 energy management with Class 1 energy metering in accordance with IEC 60557-12.

**The PXR25 premium version with display**

With the PXR25 premium version (=NZM...PX), you can keep everything in sight. For intuitive handling and to make configuration even easier, the PXR25 is equipped with a high-resolution display. You can enter the desired settings via this display. You can choose between protection settings and soft settings (additional settings). The settings of PXR switches can also be easily adjusted by using the Power Xpert Protection Manager (PXPM) software for PC.

With the PXR20 version, you can adjust the protection settings using the rotary heads on the circuit breaker itself, while the soft settings can be adjusted using the PXPM software.



## What the PXR is capable of

The most important benefits and features at a glance

### One design for all products

The consistent design for all product groups and the clear, ergonomic arrangement of the various elements ensures that the operation is the same operation and configuration of the PXR across the whole range of compact and open circuit breakers.

### Now also with LED light for status and overload indication

A green-red dual LED indicates the current status: In start-up mode, the LED is permanently green. Green flashing indicates normal operation. Red flashing indicates an error in the electronic trip unit (tripping unit). The overload LED indicates the load status of the circuit breaker. This warning can also be transmitted via the integrated communications. The PXR20 is fixed at 80 % and 105 % of  $I_r$ . The PXR25 has same default-values as the PXR20, but in this case they can be adjusted as required.

### Everything under control – thanks to the high-resolution display

The high-quality, full graphic display features a premium pixel matrix for enhanced contrast and brightness. The uniform menu navigation has been designed for maximum user-friendliness.

### Always the right setting

The new NZM is fully adjustable over an extended range. The customary PZ2 screwdriver can still be used. The VX trip unit of the NZM2 can now also be set for the instantaneous release range. In addition the NZM2 now comes with optional ground fault protection.

### The PXR – a real knack for connectivity

The PXR electronic release uses the modern communications platform provided by the CAM interface and the internal Modbus RTU module, with possible connections to numerous systems such as PROFIBUS, ProfiNet, Modbus TCP etc.

## New modules that make things easier

### Interface module

This module is used to detect the status of the circuit breaker by means of photoelectric light barriers, and for connection to enhanced functional interfaces. Each version has been specifically adapted to the respective circuit breaker type. A 24 V DC screw terminal supplies the tripping unit with power. Photoelectric sensors detect the respective device status (on/off/tripped) and relay it via the communication connection. In the event of a short circuit, zone selectivity ensures a faster and more precise shutdown. In addition, the module can be used to connect an internal Modbus RTU module, to remotely operate the ARMS maintenance mode, and to connect the CAM interface to any external communication modules.

### The internal Modbus RTU module

A Modbus RTU connection can be integrated internally, so that no external communication components are required. The connection to a superordinate system saves space and allows for the quick and cost-effective transmission of data. As a result, your system will be optimally prepared for all Industry 4.0-related tasks.

### Relay module

The relay module contains two programmable relays, in addition to established components such as the undervoltage release. These relays can be used, for example, for the remote control of drives or to control motor starters. They are equally suitable for alert notifications or status messages.



How to correctly adjust the PXR

**Overload release  $I_r$**   
 now with extended 13-point adjustment range (from 0.4 to  $1 \times I_n$ ).

**Delayed short-circuit release  $I_{sd}$**   
 To ensure the selectivity of the mains connection, the circuit breaker will trip after the set delay time  $t_{sd}$ .

**Non-delayed short-circuit release  $I_i$**   
 The threshold value can be set between 2 and  $18 \times I_n$ . The  $I_i$  value refers to the rated current  $I_n$ .

**Earth fault protection  $I_g$**   
 Should excessive earth impedance prevent the tripping of the short-circuit release, the earth fault protection will automatically issue an alert and switch off the device.

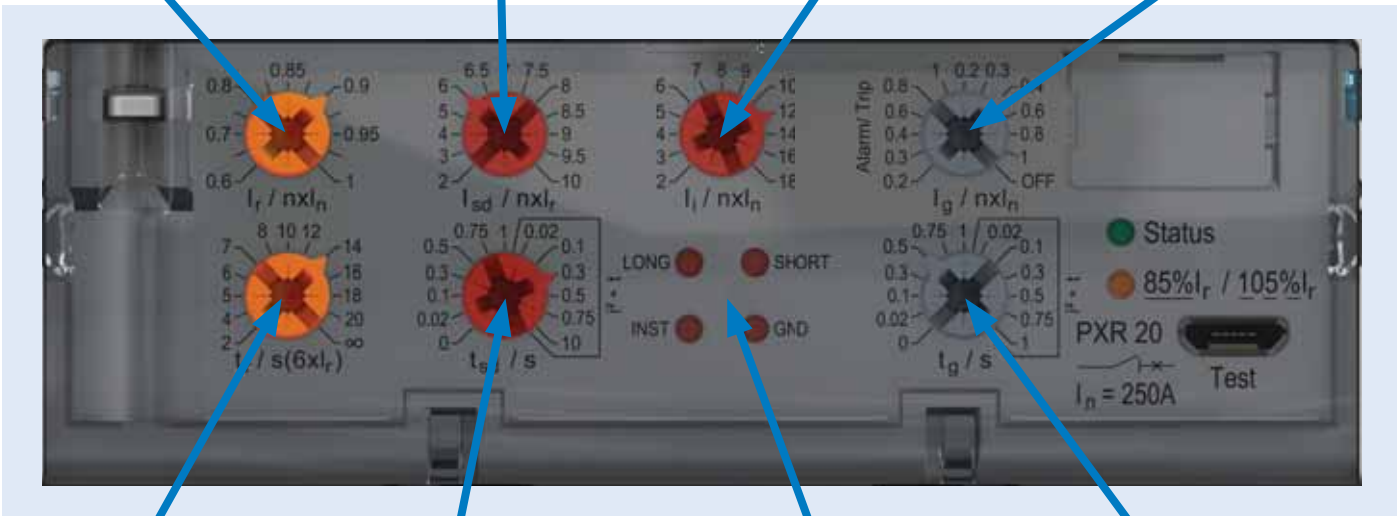

**Time lag  $t_r$**   
 Stipulates the time lag after which an overload of  $6 \times I_r$  causes the device to trip. Adjustable in increments of  $t_r = 2$  to 20 or  $\infty$ .

**Time delay  $t_{sd}$  (with reference to  $I_{sd}$ )**  
 Adjustable in 7 steps, from 0 ms to 1,000 ms, for delayed tripping in the event of a short circuit.

**“Tripped” message**  
 If the circuit breaker trips, the corresponding LED will indicate the reason, e.g. an overload.

**Time delay  $t_g$  (with reference to  $I_g$ )**  
 Thanks to the time delay  $t_g = 0$  ms to 1,000 ms, a selective shutdown is possible even in the event of an earth fault.

**Electrical parameters**

- $I_r$  – Overload release
- $t_r$  – Time lag
- $I_{sd}$  – Delayed short-circuit release
- $t_{sd}$  – Time delay
- $I_i$  – Non-delayed short-circuit release

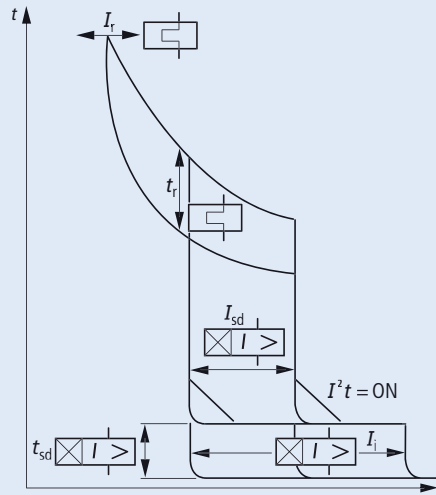

# Product overview – IEC / UL circuit breakers

TYPE		NZM1							
									
General information		NZME1	NZMB1	NZMB1	NZMC1	NZMN1	NZMS1	NZMH1	
Number of poles		1	1	3, 4	3, 4	3, 4	3, 4	3, 4	
Degree of protection of the device (operating elements)	IP20	✓							
of enclosure and bezel	IP40	✓							
of enclosures with rotary handles	IP66	✓							
Dimensions (WxHxD)		mm 30x145x84.5				3-pole: 90x145x84.5 4-pole: 120x145x84.5			
Ambient temperature	Storage at -40 °C to +70 °C Operation at -25 °C to +70 °C	✓							
Feed-in top or bottom		✓							
Mounting positions	In general NZM2 plug-in units NZM withdrawable units	Vertical and 90° in all directions							
		-	-	-	-	-	-	-	
		-	-	-	-	-	-	-	
Electrical properties in accordance with IEC 60947-2									
Rated operational current I <sub>n</sub> at 40 °C	AC-1 AC-3 for S,M, MX, PMX DC-1	A	16-125			16-160 36-81			
Rated operational voltage U <sub>e</sub>	AC 50/60 Hz DC*	V	230	440	440	16-125	690	16-125	
For use in IT networks		V	-	-	440	-	690	-	
Rated insulation voltage U <sub>i</sub>		V	400		690				
Rated impulse-withstand voltage U <sub>imp</sub>	Main contacts Auxiliary contacts	kV				6			
Utilization category						A			
Overvoltage category						III			
Pollution category						3			
Safe isolation in accordance with EN 61140						✓			
Switching capacity in accordance with IEC 60947-2									
I <sub>CU</sub> / I <sub>CS</sub> @ 50/60 Hz	240 V 400/415 V 440 V 525 V 690 V 1,000 V	kA	18 / 18	25 / 25	30 / 30	55 / 55	85 / 85	90 / 90	100 / 100
		kA	-	25 / 25	25 / 25	36 / 36	50 / 50	70 / 50	100 / 100
		kA	-	-	25 / 18.5	30 / 22.5	35 / 35	35 / 35	70 / 35
		kA	-	-	-	12 / 6	20 / 10	20 / 10	40 / 10
		kA	-	-	-	8 / 4	10 / 7.5	10 / 7.5	10 / 7.5
		kA	-	-	-	-	-	-	-
I <sub>CU</sub> / I <sub>CS</sub> @ DC*	500 V (3P) 750 V (3P)	kA	-	-	-	-	15 / 15	-	30 / 30
		kA	-	-	-	-	-	-	-
I <sub>cm</sub> @ 50/60 Hz	240 V 400/415 V 440 V 525 V 690 V 1,000 V	kA	36	53	63	121	187	198	220
		kA	-	53	53	76	105	154	220
		kA	-	-	53	63	74	77	74
		kA	-	-	-	24	40	44	40
		kA	-	-	-	14	17	20	17
		kA	-	-	-	-	-	-	-
Switching capacity in accordance with UL 489, CSA 22.2 No. 5-09									
	240 V 60 Hz	kA	-	-	35	-	85	-	-
	480/277 V 60 Hz / 480 V 60 Hz	kA	-	-	25 / -	-	35 / -	-	-
	600/347 V / 600 V 60 Hz	kA	-	-	-	-	-	-	-
Service life (AC-1)									
mechanical	max. 50 % tripping with XA/XU	O-C-O	20000						
electrical 50/60 Hz									
AC-1	415 V 690 V 1,000 V		7500			5000	10000 7500		
			-	-	-	-	-	-	-
			-	-	-	-	-	-	-
AC-3 for S, M, MX, PMX	415 V 690 V		-	-	-	-	7500	-	7,500
			-	-	-	-	5000	-	5000
Trip units									
thermo-magnetic TM	-A		✓	✓	✓	✓	✓	✓	✓
electronic (PXR)	-AX (LI) -VX (LSI) -VX...T (LSI-G) -PX (LSI + energy metering) -PX...TZ (LSI-G + energy metering + ZSI) -PX...TAZ (LSI-G + energy metering + ZSI + ARMS)		-	-	-	-	-	-	-
			-	-	-	-	-	-	-
			-	-	-	-	-	-	-
			-	-	-	-	-	-	-
			-	-	-	-	-	-	-
For motor protection									
TM	-M		-	-	✓	✓	✓	-	✓
PXR	-MX (LI)		-	-	-	-	-	-	-
PXR	-PMX (LI + energy metering)		-	-	-	-	-	-	-

\* The DC values are only valid for thermo-magnetic releases (-A). Additional technical information can be found in the product datasheet on our website.

**NZM2**



**NZM3**







**NZM4**



NZM2						NZM3					NZM4		
NZMB2	NZMC2	NZMN2	NZMS2	NZMH2	NZML2	NZMC3	NZMN3	NZMS3	NZMH3	NZML3	NZMN4	NZMH4	NZML4
3, 4	3, 4	3, 4	3, 4	3, 4	3, 4	3, 4	3, 4	3, 4	3, 4	3, 4	3, 4	3, 4	3, 4
		✓						✓				✓	
		✓						✓				✓	
		✓						✓				✓	
		3-pole: 105x184x149						3-pole: 140x275x166				3-pole: 210x401x207	
		4-pole: 140x184x149						4-pole: 185x275x166				4-pole: 280x401x207	
		✓						✓				✓	
		✓						✓				✓	
		✓						✓				✓	
		Vertical and 90° in all directions						Vertical and 90° in all directions				Vertical and 90° in all directions	
		Vertical and 90° right/left						Vertical and 90° right/left				-	
		Vertical and 90° left						Vertical and 90° left				Vertical	
20-300 81-196						250-630 196-415					630-1600 544-1600		
-	-	20-250	-	20-250	-	250-500		250-500			-		
440			690					690			690		
-	-	750	-	750			750		750		-		
440			690					690			690		
690		A/M: 1000 AX/VX/MX/PX/PMX: 690				A/M: 1000 AX/VX/MX/PX/PMX: 690					690		
		8						8			8		
		6						6			6		
		A						A			A	AX: A MX, PX: B	B
		III						III			III		
		3						3			3		
		✓						✓			✓		
30 / 30	55 / 55	85 / 85	100 / 100	150 / 150	150 / 150	55 / 55	85 / 85	100 / 100	150 / 150	150 / 150	50 / 37	125 / 63	125 / 63
25 / 25	36 / 36	50 / 50	70 / 70	150 / 150	150 / 150	36 / 36	50 / 50	70 / 70	150 / 150	150 / 150	50 / 37	85 / 50	100 / 50
25 / 18.5	30 / 22.5	35 / 35	65 / 65	130 / 130	130 / 130	30 / 22.5	35 / 35	65 / 65	130 / 130	130 / 130	35 / 26	85 / 50	85 / 50
-	12 / 6	25 / 25	36 / 36	50 / 37.5	100 / 100	12 / 9	25 / 13	36 / 18	65 / 33	100 / 50	25 / 19	65 / 50	65 / 50
-	8 / 4	20 / 5	20 / 6	20 / 5	80 / 80	8 / 4	20 / 5	25 / 6	35 / 9	80 / 20	20 / 15	50 / 37	50 / 37
-	-	-	-	-	-	-	-	-	-	-	-	-	-
-	-	30 / 7.5	-	60 / 15	-	-	30 / 30	-	70 / 70	-	-	-	-
-	-	30 / 7.5	-	60 / 15	-	-	30 / 30	-	70 / 70	-	-	-	-
63	121	187	220	330	330	121	187	220	330	330	105	275	275
53	76	110	154	330	330	76	105	154	330	330	105	187	220
53	63	77	143	286	286	63	74	143	286	286	74	187	187
-	24	55	80	105	220	24	53	80	143	220	53	143	143
-	14	40	40	40	176	14	40	53	74	176	40	100	105
-	-	-	-	-	-	-	-	-	-	-	-	-	-
35	-	85	-	150	-	-	85	150	-	-	85	125	-
25	-	35 / 35	-	100	-	-	42 / 42	100 / 100	-	-	42 / 42	85 / 85	-
18 / -	-	25 / -	-	50 / -	-	-	35 / 35	50 / 50	-	-	35 / 35	50 / 50	-
20000						15000				10000		10000	
7500		10000				5000				2000		3000	
-	5000	7500				3000						2000	
-	-	-				-						-	
-	-	6500				2000						2000	
-	-	5000				2000						1000	
✓	✓	✓	✓	✓	-	✓ ≤ 500 A	✓ ≤ 500 A	✓ ≤ 500 A	✓ ≤ 500 A	-	-	-	-
-	-	✓	✓	✓	✓	-	✓	✓	✓	✓	✓	✓	✓
-	-	✓	✓	✓	✓	-	✓	✓	✓	✓	✓	✓	✓
-	-	✓	✓	✓	✓	-	✓	✓	✓	✓	✓	✓	✓
-	-	✓	✓	✓	✓	-	✓	✓	✓	✓	✓	✓	✓
-	-	-	-	-	-	-	✓	✓	✓	✓	✓	✓	✓
✓	✓	✓	-	✓	-	-	-	-	-	-	-	-	-
-	-	✓	✓	✓	✓	-	✓	✓	✓	✓	✓	✓	✓
-	-	✓	-	✓	✓	-	-	-	✓	✓	✓	✓	✓

# Product overview – switch-disconnectors

TYPE			PN1/N1	PN2/N2	PN3/N3	N4
						
<b>General information</b>						
Number of poles			3, 4	3, 4	3, 4	3, 4
Degree of protection of the device (operating elements)	IP20				✓	
of enclosure and bezel	IP40				✓	
of enclosures with rotary handles	IP66				✓	
Dimensions (WxHxD)		mm	3-pole: 90x145x84.5 4-pole: 120x145x84.5	3-pole: 105x184x149 4-pole: 140x184x149	3-pole: 140x275x166 4-pole: 185x275x166	3-pole: 210x401x207 4-pole: 280x401x207
Ambient temperature	Storage at -40 °C to +70 °C Operation at -25 °C to +70 °C				✓	
Direction of current supply top or bottom					✓	
Mounting positions	In general		Vertical and 90° in all directions			
	with plug-in units		-	Vertical and 90° left	Vertical and 90° right/left	-
	with withdrawable units		-	-	Vertical and 90° left	Vertical
<b>Electrical properties in accordance with IEC 60947-3</b>						
Rated operational current $I_n$ at 40 °C	AC-1	A	max. 160	max. 250	max. 630	max. 1,600
	AC-22A, (AC-23 for (PN..))	A	max. 160	max. 250	max. 630	max. 1,600
	DC-22A (DC-21A for N...S15-PV-NA)	A	-	-	-	-
Rated operational voltage $U_e$	AC 50/60 Hz	V	690	690	690	690
	DC	V	-	-	-	-
For use in unearthed networks		V AC	690	690	690	525
Rated insulation voltage $U_i$		V	690	690	1,000	1,000
Rated impulse-withstand voltage $U_{imp}$						
	Main contacts	kV	6	8	8	8
	Auxiliary contacts	kV			6	
Overtoltage category					III	
Pollution category					3	
Safe electrical disconnection in accordance with IEC 60947-3					✓	
<b>Switching capacity in accordance with IEC 60947-3</b>						
Rated short-circuit making capacity	$I_{cm}$	kA	2.8	5.5	25	53
Rated short-time current	$I_{cw}$					
	t = 0.3 s	kA	2	3.5	12	25
	t = 1 s	kA	2	3.5	12	25
Rated short-circuit current $I_q$	With fuse upstream	A gG/gL A gR	PN1(N1)-63...125: 125 PN1(N1)-160: 160	PN2(N2)-160...250: 250	PN3(N3)-400...630: 630	PN4(N4)-630...1600: 2x800
	With fuse upstream	kA	100	100	100	100
	400/415 V	kA	80	80	80	80
	1,000 V	kA	-	-	-	-
	With fuse downstream	A gG/gL A gG/gL	PN1(N1)-63...125: 125 PN1(N1)-160: 160	PN2(N2)-160...250: 250	PN3(N3)-400...630: 630	PN4(N4)-630...1600: 2x800
	400/415 V	kA	100	100	100	100
690 V	kA	10	80	80	80	
<b>Service life</b>						
Mechanical		O-C-O	20000	20000	15000	10000
Maximum operating frequency		Operations / h	120	120	60	60
Electrical 50/60 Hz						
AC-1	415 V		10000	10000	5000	3000
	690 V		7500	7500	5000	2000
	1,000 V		-	-	-	-
AC-3 ((PN1: AC23)	415 V		7500	7500	3000	2000
	690 V		5000	5500	2000	1000
DC-22A (DC-21A for N...S15-PV-NA)						

Additional technical information can be found in the product datasheet on our website.

N2...-DC...



N3...-DC...



N4...-DC...







N4...-PV-NA



4	4	4	4
		✓	
		✓	
		✓	
140x184x149	185x275x166	280x401x207	
		✓	
		✓	
		✓	
Vertical and 90° in all directions			
		-	
		-	
		-	
250	550	1,600	1,200
N...-S1-DC: 1,000 N...-S15-DC: 1,500	N...-S1-DC: 1,000 N...-S15-DC: 1,500	N...-S1-DC: 1,000 N...-S15-DC: 1,500	N...-S1-DC: 1,000 N...-S15-DC: 1,500
N...-S1-DC: 1,000 N...-S15-DC: 1,500	N...-S1-DC: 1,000 N...-S15-DC: 1,500	N...-S1-DC: 1,000 N...-S15-DC: 1,500	N...-S1-DC: 1,000 N...-S15-DC: 1,500
N...-S1-DC: 1,250 N...-S15-DC: 1,500	N...-S1-DC: 1,250 N...-S15-DC: 1,500	N...-S1-DC: 1,250 N...-S15-DC: 1,500	N...-S1-DC: 1,250 N...-S15-DC: 1,500
N...-S1-DC: 8 N...-S15-DC: 10	N...-S1-DC: 8 N...-S15-DC: 10	N...-S1-DC: 8 N...-S15-DC: 10	N...-S1-PV-NA: 8 N...-S15-PV-NA: 10
		6	
		III	
N...-S1-DC: 3 N...-S15-DC: 2	N...-S1-DC: 3 N...-S15-DC: 2	3	3
		✓	
		-	
		-	
3.6	6.6	34 (0.1 s)	34 (0.1 s)
A gR/gPV 200	A gR/gPV 2x250	-	-
		-	
		-	
15	15	-	-
		-	
		-	
		-	
		-	
20000	15000	10000	10000
120	60	60	60
		-	
		-	
		-	
		-	
1000	1000	500	500



# Circuit breakers

NS...-...NA				NS1...-NA	NS2...-NA	NS3...-NA	NS4...-NA
							
<b>Circuit breaker</b>				<b>max. 125 A</b>	<b>max. 250 A</b>	<b>max. 600 A</b>	<b>max. 1,200 A</b>
Rated peak-withstand current		$U_{imp}$					
Main circuits		V		6000	8000	8000	8000
Auxiliary circuits		V		6000	6000	6000	6000
Rated operational voltage		$U_e$	V AC	690	690	690	690
Max. rated uninterrupted current							
IEC/EN 60947-2 Annex L		$I_n$	A	125	250	600	1200
UL489/CSA 22.2 No. 5.1		$I_n$	A	125	250	600	1200
Overtoltage category/degree of pollution				III/3	III/3	III/3	III/3
Rated insulation voltage		$U_i$	V	690	1000	1000	1000
<b>Switching capacity in accordance with UL 489, CSA 22.2 No. 5.1</b>							
	240 V 60 Hz		kA	85	150	150	85
	480 V 60 Hz		kA	35	100	100	65
	600 V 60 Hz		kA	-	50	50	42
<b>Products intended for the North American market have a different switching capacity</b>							
Rated short-circuit making capacity	240 V 50/60 Hz	$I_{cm}$	kA	187	330	330	187
	400/415 V 50/60 Hz	$I_{cm}$		105	330	330	154
	440 V 50/60 Hz	$I_{cm}$	kA	74	286	286	143
	525 V 50/60 Hz	$I_{cm}$	kA	53	105	143	84
	690 V 50/60 Hz	$I_{cm}$	kA	17	53	74	74
Rated short-circuit breaking capacity $I_{cc} = I_{cu}$ in accordance with IEC/EN 60947-2 Annex L							
$I_{cu}$ to IEC/EN 60947, switching sequence O-t-CO	240 V 50/60 Hz	$I_{cm}$	kA	85	150	150	85
	400/415 V 50/60 Hz	$I_{cm}$	kA	50	150	150	70
	440 V 50/60 Hz	$I_{cm}$		35	130	130	65
	525 V 50/60 Hz	$I_{cm}$	kA	20	50	85	40
	690 V 50/60 Hz	$I_{cm}$	kA	10	20	35	35
$I_{cu}$ to IEC/EN 60947, switching sequence O-t-CO-t-CO	240 V 50/60 Hz	$I_{cm}$	kA	85	150	150	43
	400/415 V 50/60 Hz	$I_{cm}$	kA	50	150	150	35
	440 V 50/60 Hz	$I_{cm}$	kA	35	130	130	33
	525 V 50/60 Hz	$I_{cm}$	kA	10	37.5	33	20
	690 V 50/60 Hz	$I_{cm}$	kA	7.5	5	9	18
Service life, mechanical (of which max. 50 % is tripped by the shunt/undervoltage release)		Switching operations		20000	20000	15000	10000
Maximum operating frequency		ops./h		120	120	60	60
Service life, electrical							
AC-1	400/415 V 50/60 Hz	Switching operations		10000	10000	5000	3000
	690 V 50/60 Hz	Switching operations		7500	7500	3000	2000
Total downtime in the event of a short circuit		ms		< 10	< 10	< 10	< 25 ≤ 415 V < 35 > 415 V

Additional technical information can be found in the product datasheet on our website.



# Accessories

TYPE		NZM1		NZM2		NZM3		NZM4	
									
<b>Internal accessories</b>									
Auxiliary contacts	M22-(C)K...	✓	✓	✓	✓	✓	✓	✓	✓
Trip-indicating auxiliary contacts	M22-(C)K...	✓	✓	✓	✓	✓	✓	✓	✓
Early-make auxiliary contacts	NZM...XHIV...	✓	✓	✓	✓	✓	✓	✓	✓
Undervoltage releases	NZM...XU...	✓	-	✓	-	✓	-	✓	✓
Undervoltage releases with relay module	NZM...XU.A...	-	-	✓ (PXR)	-	✓ (PXR)	-	✓ (PXR)	✓ (PXR)
Shunt releases	NZM...XA...	✓	-	✓	-	✓	-	✓	✓
Shunt releases with relay module	NZM...XA.A...	-	-	✓ (PXR)	-	✓ (PXR)	-	✓ (PXR)	✓ (PXR)
Relay modules	NZM...XBSM	-	-	✓ (PXR)	-	✓ (PXR)	-	✓ (PXR)	✓ (PXR)
<b>External accessories</b>									
<b>Actuator</b>									
with thumb grip		✓	✓	✓	✓	✓	✓	✓	✓
Rotary handle, direct	NZM...XDV...	✓	✓	✓	✓	✓	✓	✓	✓
Rotary handle with shaft extension	NZM...XTVD...	✓	✓	✓	✓	✓	✓	✓	✓
Rotary handle, lateral	NZM...XS	✓	✓	✓	✓	✓	✓	✓	✓
Rotary handle with side lever (UL/CSA)	NZM...SXH	-	-	✓	✓	✓	✓	✓	✓
Rotary handle, at the rear	NZM...SXH	✓	✓	✓	✓	-	-	-	-
Remote operator (electrical)	NZM...XR...	-	-	✓	✓	✓	✓	✓	✓
<b>Residual-current protection</b>									
Residual-current circuit breaker – mountable	NZM...XFI	✓	✓	✓	✓	-	-	-	-
Ground fault relay – cannot be mounted directly	ELR...	✓	✓	✓	✓	✓	✓	✓	✓
<b>Type of installation</b>									
Fixed	NZM...	✓	✓	✓	✓	✓	✓	✓	✓
Plug-in units	NZM...SVE	✓	-	✓	-	✓	-	-	-
Withdrawable units	NZM...AV	-	-	-	-	✓	-	-	✓
<b>Covers</b>									
Cable lug cover	NZM...XKSAE	-	-	✓	✓	✓	✓	-	-
Terminal cover	NZM...XKSA...	✓	✓	✓	✓	✓	✓	✓	✓
Phase isolator	NZM...XKP...	✓	✓	✓	✓	✓	✓	✓	✓
Terminal cover	NZM...XKSFA...	✓	✓	✓	✓	✓	✓	-	-
Finger guard	NZM...XIPK...	✓	✓	✓	✓	✓	✓	-	-
<b>Terminal type</b>									
Screw-in/direct connection	NZM...XKS...	✓	✓	✓	✓	✓	✓	✓	✓
Box terminal	NZM...XKC...	✓	✓	✓	✓	✓	✓	-	-
Connection at rear	NZM...XKR...	✓	✓	✓	✓	✓	✓	✓	✓
Tunnel terminal	NZM...XKA...	✓	✓	✓	✓	✓	✓	✓	✓
Control-circuit terminal	NZM...XST...	✓	✓	✓	✓	✓	✓	✓	✓
Connection expansion	NZM...XKV...	-	-	-	-	✓	✓	✓	✓
Module plate	NZM...XKM...	-	-	-	-	-	-	-	✓

Additional technical information can be found in the product datasheet on our website.

## Type design of the basic devices

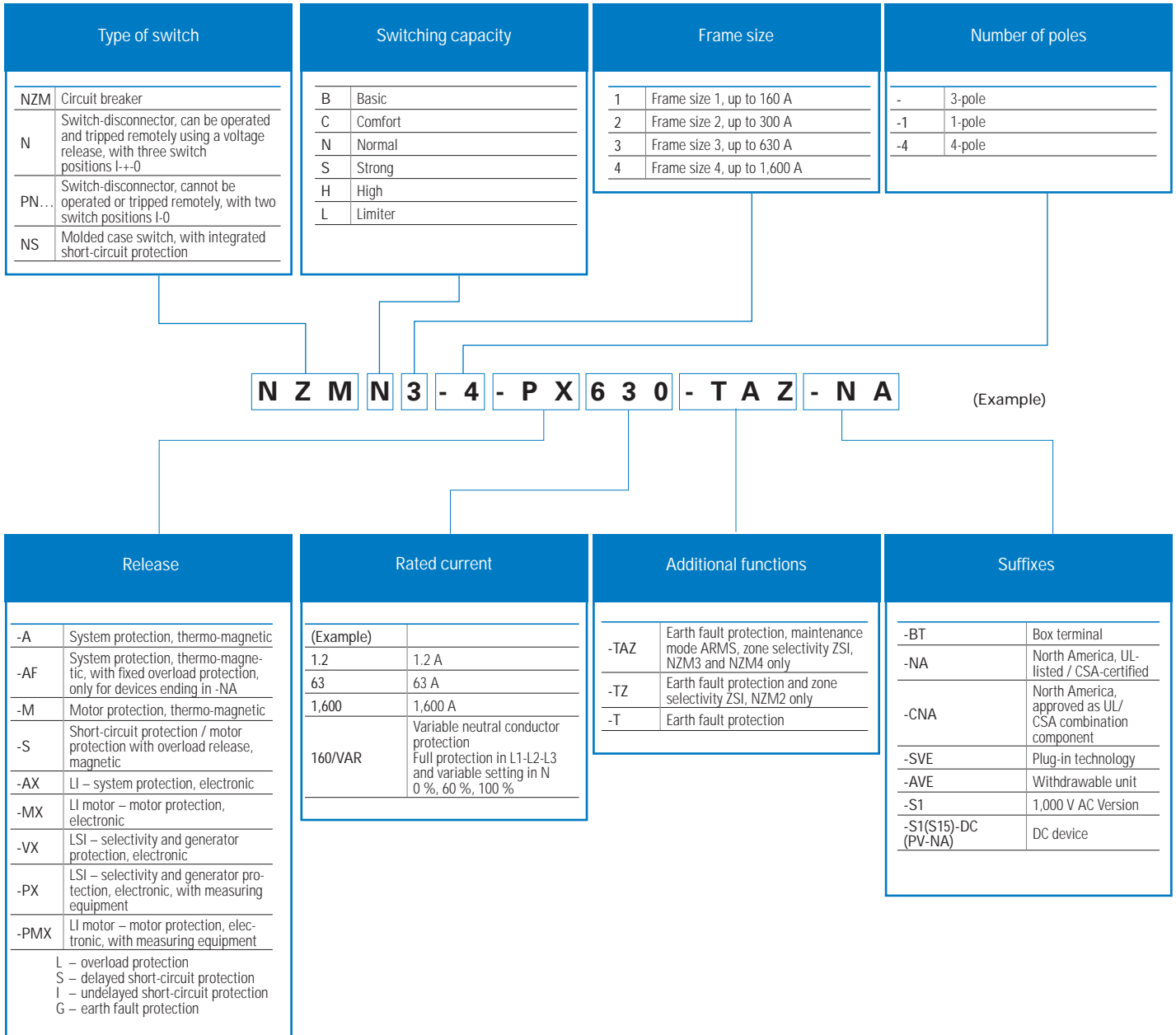

# Conformity to standards

## Circuit breakers for global use

All circuit breakers meet the requirements for global use. This also applies to the United States, Canada and the Chinese market, with UL, CSA and CCC (China Compulsory Certification) certifications.

In cooperation with the ship classification societies, Eaton is carrying out a series of tests in order to receive the following approvals: Lloyds Register of Shipping, Bureau Veritas, Det Norske Veritas, Polski Rejestr Statkow, China Classification Society, Germanischer Lloyd and Russian Maritime Register of Shipping.

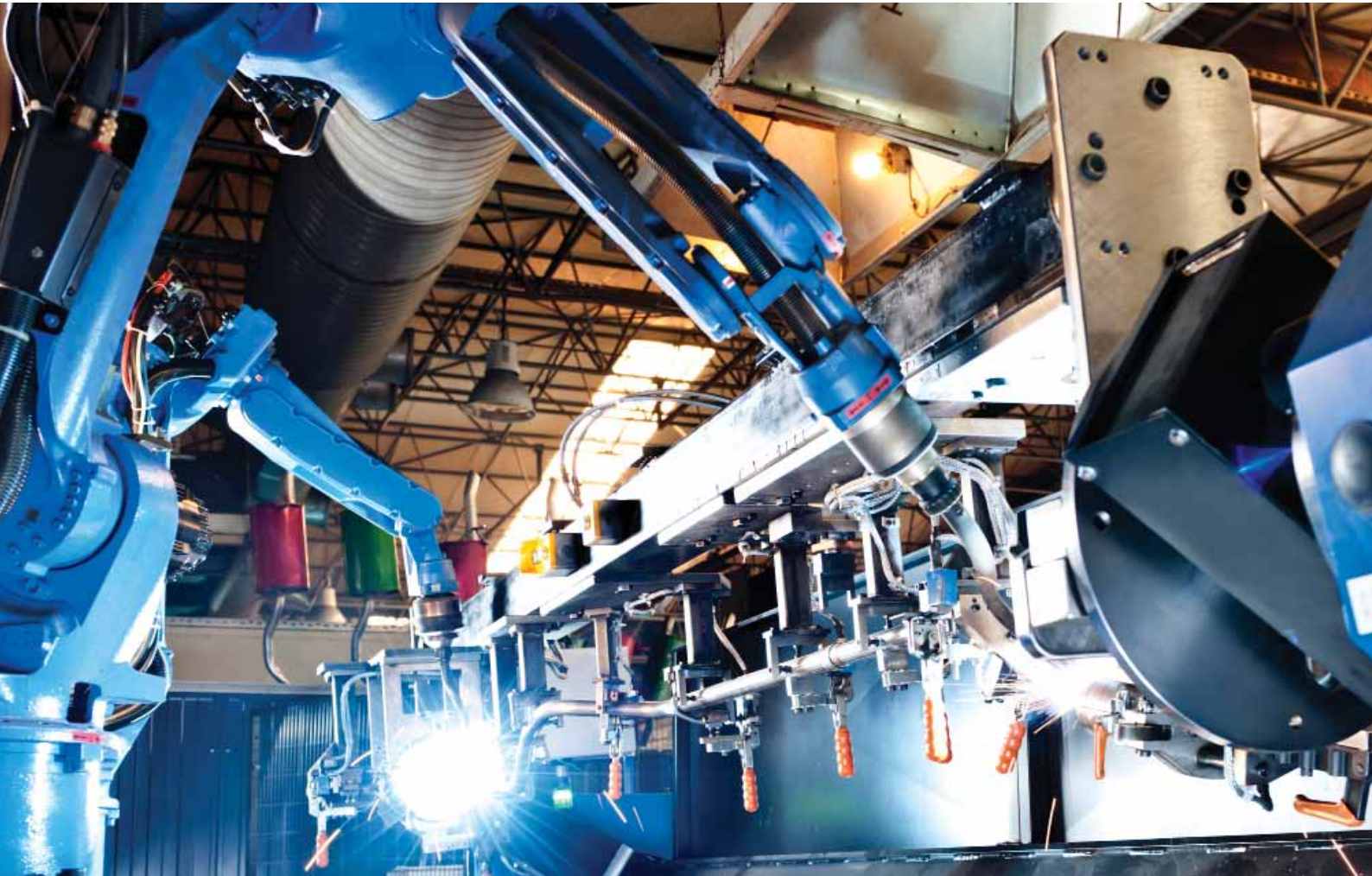



## System and cable protection

Across all levels



**The NZM circuit breakers protect entire systems and cables across all levels, from the main distribution board all the way to the load itself.**

**Based on your requirements, you can choose between the T/M version for standard applications and the ETU version with a wider setting range as well as diagnostic and test functions via USB.**

The T/M version for system and cable protection features a robust design and a bimetallic strip release that ensures overload protection for the setting range of  $I_r = 0.8$  to  $1 \times I_n$ . The magnetic release has a setting range of  $6$  to  $10 \times I_n$ . In the ETU version, the setting range of the overload has been extended to  $I_r = 0.4$  to  $1 \times I_n$ . This means, for example, that a 250 A circuit breaker can safely operate rated operational currents up to 100 A.

This provides enhanced flexibility when it comes to selection and planning. The circuit breakers for system and cable protection can also be tested via the integrated micro-USB interface, using the Power Xpert Protection Manager (PXPM) software. Thanks to the integrated test protocol function, a report in PDF format can be easily generated.



## Protection of motors and motor-starter combinations in case of overload and short circuit events



**With a range of 16 A to 1,400 A, the NZM circuit breakers provide reliable protection for motors and input wiring in the event of overloads, short circuits and phase failure. To prevent the protective device from switching off during start-up peaks, the short-circuit releases can be set at up to 18 times the rated current. The extended setting range even protects energy-efficient motors with high starting currents.**

The NZM motor-protective circuit breakers meet the requirements for tripping characteristics outlined in IEC/EN 60947-4-1 as well as the associated requirements for phase-failure sensitivity and phase-failure protection.

Motor-starter combinations can be controlled via the communication connection and the relay module (also in conjunction with an undervoltage release, for example). DOL starters, reversing starters and circuits with heavy starting duty can all be implemented. The contactor coils can either be automatically controlled directly from the NZM, or manually via the communication connection.

In the event of an overload, the extended ZMR functionality offers a sophisticated option for contactor release prior to the tripping of the NZM. As a result, temporary overloads of 110 % of  $I_n$  can be switched off and then automatically back on again without any need to trip or reset the NZM. Alternatively, the device can also be set to issue an alert only.

The devices intended for motor protection are all IE3/IE4-compatible, to prevent undesired tripping in energy-efficient motors. The new electronic releases have been further optimized for applications with high in-rush currents.

## Full-range protection

For system protection, cable protection, selectivity and generator protection



**As an incoming circuit breaker, the NZM naturally also offers overload protection on the secondary side of the transformer. A version with time-delayed short-circuit releases is also available, to ensure the selectivity of the mains connection. This option is especially suitable if power is supplied via a transformer or a generator, and in IT and TN networks with long cables.**

You can fully rely on the NZM circuit breakers, even if the generators struggle to produce between two and six times the continuous current in the event of a short circuit. The NZM will safely switch off even very low short-circuit currents within just a few milliseconds. If special tasks require it, the circuit breakers can be set so that short-circuit currents up to 10 times the rated current will be ignored for up to one second.

Thanks to the extended setting range of the full-range release, the devices can be optimally adapted to any application. Whether it is generator protection, the support of extremely long outputs with low short-circuit currents, or the protection of transformers in case of very high in-rush currents, the NZM circuit breaker can do it all.

## Earth fault protection

With current-dependent short-time delay



**Residual currents to earth are detected based on the core-balance principle by means of the integrated converters. The circuit breaker will trip or issue an alert in line with the selected settings, and the setting range can be set at 20 % to 100 % of the rated operational current. It is possible to delay the tripping by up to one second.**

## Selectivity and backup protection

For maximum supply security

### Selective overload and short-circuit protection

A combination of two or more short-circuit protection devices, such as a circuit breaker and a fuse, for example, is considered selective if only the protective device located directly upstream of the fault trips. This will interrupt the

current flow, which prevents the downstream switches from responding. This ensures that those system parts that have not been affected by the fault will continue to be operational. The NZM circuit breakers are able to achieve selectivity even without the addition of any electronic short-time delay devices.

### Selectivity viewed schematically

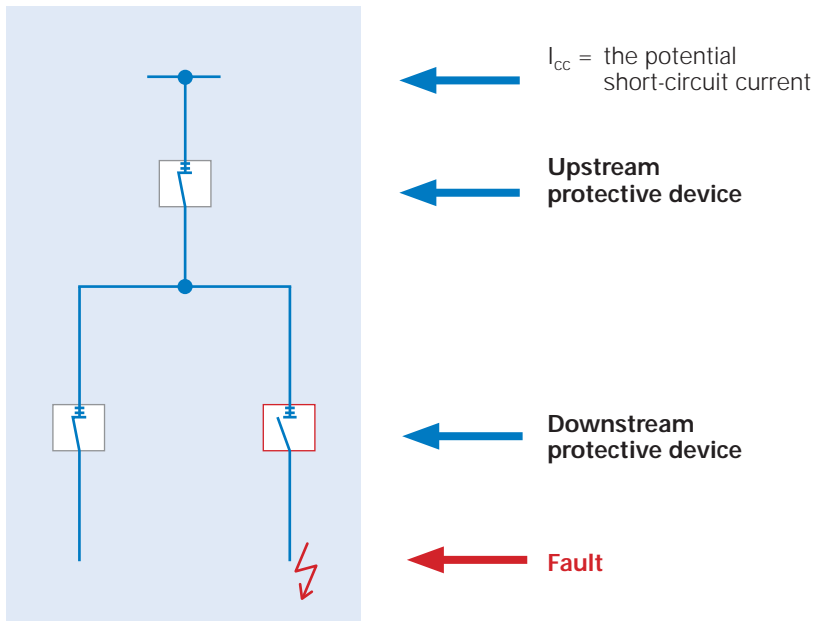

### Backup protection against excessive short-circuit currents

Backup protection is provided if the upstream protective device is able to protect the downstream protective device against excessive short-circuit currents. If the short-circuit current exceeds the short-circuit capacity  $I_{cu}$  of the downstream circuit breaker, the upstream circuit breaker will limit the current flow to ensure optimum protection of the system.

NZM frame sizes 1, 2 and 3 have a current-limiting effect. The take-over current  $I_B$  of the upstream circuit breaker, i.e. the current at which the latter trips, must not be greater than the  $I_{cu}$  of the downstream circuit breaker. This ensures backup protection against all potential short-circuit currents.

Detailed information on selectivity and backup protection can be found in Eaton's "Selectivity, Backup Protection and Coordination Guide".

## Zone selectivity and ARMS maintenance mode

Precise disconnection of faults upstream from their location and protection against arc faults

### Zone selectivity

Zone selectivity is the next stage in the concept of time selectivity. In contrast to time selectivity, any faults will be switched off instantaneously and at any point in the network. This keeps the energy that is being generated ( $I^2 \times t$ ) –

and thus the thermal and dynamic system load – as low as possible.

For this purpose, the circuit breakers are connected to a signal cable. In the event of a fault, the signal cable ensures that only the circuit breaker located

directly upstream of the fault (i.e. the circuit breaker that feeds into the short circuit) switches off immediately. This keeps that part of the system that has not been affected by the fault operational and thereby minimizes downtime.



### ARMS – Arcflash Reduction Maintenance System

Our circuit breakers can be optionally equipped with our new, patented Arcflash Reduction Maintenance System. In the event of an arc fault, this system

ensures an immediate and accelerated shutdown.

The disconnection is even faster than that effected by a non-delayed short-circuit release. This feature can either be activated

directly at the circuit breaker or via an external switch, for example when maintenance personnel enter a hazardous area. No special wiring is required.



### More safety when working on live electrical circuits

Safety is Eaton's top priority. Therefore, we offer additional safety functions that go beyond the standard requirements. In this white paper you can find out what advantages this has for users.



## Residual-current protection

For universal mounting, or for mounting directly on the circuit breaker



### For universal mounting

Eaton's new relay/transformer combinations cover operating currents from 1 A to 1,800 A. The wide range of applications extends from general power distribution systems to individual motor feeders. The relay can detect and process residual currents between 30 mA and 5 A.

The scope of application of the individual relay/transformer combinations depends on the applicable regulations, and ranges from personnel and fire protection to general power protection for 1 to 4-pole networks.

### Compact, safe, versatile...

... these are the qualities required of residual-current protection devices, especially in areas – such as installation boards – where space is limited. The measuring relay can be snapped onto a DIN rail as required. It forms a functional unit with the ring-type transformers, which are arranged along the power chain to save space.



### For direct mounting on the circuit breaker

The residual-current release modules can be mounted flush with the bases of the NZM1 and NZM2 circuit breakers (in the case of the NZM1 also on the right). Eaton thus offers a compact product that is easy to install without the need for external auxiliary voltage.

The residual-current protection module of the NZM2 is fully independent of the mains voltage and can therefore be used for the purposes of personnel protection in Germany.

Both pulse-current and AC/DC-sensitive devices are available. For virtually any mains constellation, 3 and 4-pole versions are possible, with different rated residual currents ranging from 30 mA to 3 A (with time selectivity).

## Protection of DC applications

For use as circuit breakers or switch-disconnectors



### Circuit breakers DC applications

The NZM circuit breakers with thermo-magnetic releases can be used for DC applications. However, using the circuit breakers in DC environments alters their technical characteristics. As a result, the threshold value of the short-circuit release has to be adjusted. In addition, the short-circuit breaking capacity will also be affected.

The NZM...-S07-DC circuit breaker has been designed specifically for use in battery applications. As such, the threshold value of the short-circuit release is set especially low to ensure reliable control of the low short-circuit currents in the battery banks.

### Switch-disconnectors for DC applications

Our powerful range of switch-disconnectors for DC use comprises three frame sizes, from 160 A to 1,600 A, for applications with 1,000 V DC or 1,500 V DC. The devices are IEC 60947-3 and UL489B approved and can therefore be used worldwide. Together with the wide and versatile range of NZM accessories, the DC switch-disconnectors are the ideal choice for demanding DC applications, including (but not limited to) central inverters used in renewable energy systems.

The tested combination of switch-disconnector and 1 or 2-pole link set is especially powerful, and the perfect option for every type of connection situation and for environments with high ambient temperatures. Eaton can guarantee reliable derating values up to 70 °C. The DC switch-disconnectors can also be used without restriction in unearthed IT networks, provided the error case of a double earth fault can be ruled out by means of technical measures.



## Protection for special applications

With high power density



### Circuit breakers with high switching capacity at 690 V AC

The NZML2 and NZML3 circuit breakers complement the globally recognized NZM family and complete Eaton's offering for systems with high power density. High switching capacities at 690 V AC are not only required in mining, marine applications or the chemical industry; the new products have also been designed with renewable energy systems such as wind turbines in mind.

Our product portfolio covers virtually any demand: The NZML2 is available with up to 160 A, while the NZML3 covers the range up to 400 A. Both devices come with integrated electronic trip units. They offer a switching capacity of 80 kA at 690 V AC. The devices have been equipped with a communications interface and come in the same dimensions as our proven NZM2 and NZM3 circuit breakers. Users of the NZML series have the full range of NZM accessories at their disposal.

Main fields of application:

- Mining
- Shipbuilding
- Industrial applications
- Wind turbines
- Data centers

You can find more information in the Eaton brochure "The circuit breaker series NZML2 and NZML3 for high breaking capacities at 690 V"





**Using the NZM circuit breakers at 1,000 V AC**

With the tailor-made models for rated operational voltages up to 1,000 V AC, we have further expanded the scope of application of our NZM circuit breakers and switch-disconnectors. These devices are particularly suitable for use in challenging environmental conditions, notably in the areas of mining, road tunnels, refineries, chemical plants and electric railways. Typical applications include high-power drives and general power supply systems for industrial applications with long supply lines.

### Using the NZM circuit breakers in IT networks



#### 1. Faults between the phases

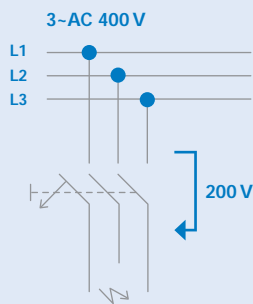

All NZM circuit breakers can be used in unearthed IT networks, unless otherwise indicated. The following must be observed during project planning:

**Why do I have to assume that the voltage in the IT system is  $\sqrt{3}$  times the mains voltage?**

#### Behavior in TN and TT systems

For circuit breakers in TN and TT systems, the three-phase short circuit to earth is the short circuit with the highest load. To determine the voltage present at each contact, the mains voltage has to be divided by  $\sqrt{3}$ .

Example:

In a TN-S system with 400 V AC, each circuit breaker contact switches only 230 V AC in the event of a three-phase short circuit to earth. ( $400 \text{ V} / 1.73$ ).

#### 2. Earth fault (simple fault)

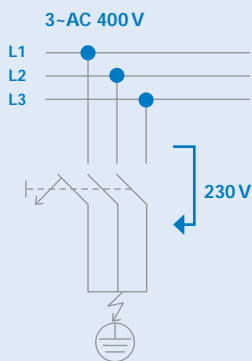

#### Short circuit in the IT system

Short circuits between the phases are also possible in IT systems. In this case, however, the short circuit will be disconnected by two separate contacts inside the circuit breaker, so that each contact only has to switch off half the mains voltage (as illustrated in figure 1, each contact should switch 200 V AC). The short circuit between two phases represents a lower load for the circuit breaker than the three-phase short circuit to earth.

#### 3. Earth fault (double fault)

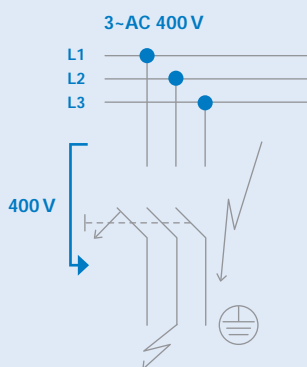

#### Double earth faults in IT systems

In IT systems, double earth faults are the short circuits with the highest possible loads. When planning for short circuits, it should always be assumed that a double earth fault will be present; this is also explicitly pointed out in IEC/EN 60947-2, Annex H. In case of a double earth fault, the full mains voltage will be applied to the circuit breaker contact in question (see figure 3 on the left). In this case, one contact alone has to switch off the entire chained voltage (mains voltage). Since the chained voltage is  $\sqrt{3}$  times (1.73) the voltage to earth, the short-circuit breaking capacity in the IT network should be planned for as  $\sqrt{3}$  the mains voltage.

#### Technical safety parameters

The NZM circuit breakers can be used in conjunction with undervoltage releases in order to calculate the safety-related parameters (e.g.  $B10_d$  or  $MTTF_d$ ). Detailed information can be found here:

Technical safety parameters  
[www.eaton.eu/safety](http://www.eaton.eu/safety)

## Energy metering with the digital NZM

Measurement data for ISO 50001

With Class 1 energy-metering accuracy in accordance with IEC 61557-12



### Greater efficiency with ISO 50001

The EN ISO 50001 standard was defined at the international level to facilitate the implementation of in-house energy management systems. The most important aim of the standard is the sustainable reduction of energy costs, energy consumption and CO<sub>2</sub> emissions by means of organizational and technical changes. Both for globally connected companies and for small and medium-sized businesses, sound energy management can lead to enhanced cost transparency and cost savings, while also contributing to the protection of natural resources and to a better corporate image. Especially for power-intensive companies whose consumption exceeds 10 GWh, or whose electricity costs account for more than 14 % of the value added, the German Renewable Energy Sources Act harbors enormous cost reduction potentials in the form of lower energy taxes.

### The importance of accurate metrics and analytics

Prerequisites for introducing an energy management system in accordance with ISO 50001 are accurate energy metrics, the identification of the main energy consumers and a full analysis of the company's energy costs. This creates a sound foundation for realizing concrete energy-efficiency improvements. Eaton offers a broad range of innovative products for monitoring, measuring and analyzing energy data.

### ISO 50003 – new as of October 2017

Since October 2017, new energy-efficiency requirements have been in place following the publication of the ISO 50003 standard. From now on, companies with certified energy management systems will have to provide hard data to prove the energy-efficiency gains they have realized. With our innovative energy metering technology, we are able to support you in meeting the stricter certification criteria.

### Product cost efficiency through precise measurement

To compete in today's markets, cost-optimized products must be manufactured. By measuring the energy requirements of production machines, the energy costs incurred for the production of the individual product can be precisely calculated. The more precise the measurement, the more precise the calculation of the proportional energy costs of the individual product. Especially when large production volumes and short cycle times come together, a very precise measurement is profitable, as incorrect values will otherwise falsify the cost calculation.

## Communications

### Effective energy management systems



#### **Saving space – quick and safe connection**

With the integrated Modbus RTU module, you will save space inside the control panel. In addition, the process of planning your system is now more flexible and cost-effective thanks to the modular interface module. This reduces the time and effort required for installation as well as the overall size of the control cabinet. The handling of the devices has also been simplified thanks to the new push-in terminals. This not only reduces the likelihood of errors, but also simplifies preparation and wiring and ensures that your installation concept meets the highest safety requirements.

#### **Centralized data collection – integration into existing systems**

Eaton's centralized data collection system consolidates the operating data of the entire system to ensure their rapid transmission.

The operating data are collected in a uniform format by all IZMX air circuit breakers, all NZM compact circuit breakers and all other PXR modules. For you, this means that the amount of programming work required across the system will be much lower.

In addition, the CAM module simplifies the integration of existing communications systems, such as Profibus DP, ProfiNet or Modbus TCP. Eaton has thus made it much easier to connect your existing architecture.

#### **Full access at all times – conveniently with remote control**

Via the integrated communications of the PXR and additional modules, such as a remote operator, motor-starter combinations etc., you will have full access to the circuit breaker at all times. The remote operator can be conveniently controlled via the communication connection in combination with the relay module. The relays can also be used to control other devices, e.g. automatic contactor releases at low overloads. You will thus benefit from a significant increase in security while saving time.



## Everything at a glance

With the new, integrated communications platform



Reliable and efficient data collection, with Eaton's PXR circuit breakers and measurement and communication modules. Providing users with data in the required form and data format is a challenge, not least given the many different types of communications architectures used in industry today.

Eaton has answered this challenge by creating a variable topology of measuring points in order to meet the demands of users. Eaton offers a comprehensive range of communication interfaces to meet the demands of the market. Based on this structure, the data can be transferred to other communication platforms via various interfaces and gateways as required.



## Features and measurement values of the PXR variants

	NZM...-AX...	NZM...-VX/MX...	NZM...-PX/PMX...
Power Xpert Release version	PXR10	PXR20	PXR25
<b>Connectivity</b>			
Test option / PXP connection via USB	✓	✓	✓
Interface module with CAM connection	-	optional	✓
Internal Modbus RTU module	-	optional	optional
Relay module	-	optional	optional
<b>Provision of the measured data</b>			
<b>Current</b>			
In real time, value per phase and neutral conductor	✓	✓	✓
Average	✓	✓	✓
Asymmetry in %	✓	✓	✓
Min/max	✓	✓	✓
<b>Voltage</b>			
In real time, phase-phase / phase-neutral	-	-	✓
Asymmetry in %	-	-	✓
Min/max	-	-	✓
<b>Frequency</b>			
In real time	-	-	✓
Min/max	-	-	✓
<b>Real/apparent/reactive energy Class 1</b>			
Total	-	-	✓
Forward	-	-	✓
Backward	-	-	✓
Net	-	-	✓
<b>Real/apparent/reactive energy Class 1</b>			
In real time	-	-	✓
Min/max	-	-	✓
<b>Power factor</b>			
	-	-	✓
<b>Maintenance information and notifications</b>			
Service life indicator	-	-	✓
LED display	status, alert	status, alert, trip reason	status
LCD display	-	-	settings, alert, trip reason
<b>Safety-related functions</b>			
ARMS maintenance mode	-	-	optional
ZSI zone-selective interlocking	-	-	optional
Thermal memory	✓	✓	✓
Ambient temperature compensation	✓	✓	✓

## The universal PXP software

One program for all Eaton devices with PXR electronics

### Power Xpert Protection Manager

With the new PXP software, Eaton has developed a universal program that will allow you to conveniently manage all Eaton PXR devices.

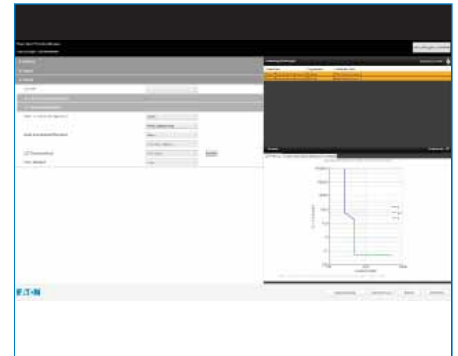

Main features:

- Configuration and settings
- Retrieval and evaluation of data
- Test function

With the PXR technology, configuring, controlling, protecting and testing the system architecture of your Eaton devices is easier than ever before, thanks to the integrated Power Xpert Protection Manager. It is no longer necessary to manually identify the various devices, as the program automatically adapts to each. Guided and drop-down menus ensure that the configuration process is as user-friendly as possible. And the recorded data are always clearly displayed via a single screen.

The PXP software speaks your language: Eaton provides you with a wide range of language packs; the system can either recognize the language of your computer automatically, or you can set it manually.

A wide selection of additional options allows you to select application-specific settings exactly as required:

- The protective function can be adapted and controlled via the display and by configuring the trip type.
- The waveforms of both current and voltage can be automatically captured and displayed before and after tripping, or manually via the "waveform capture" function.

## Eaton software for a broad range of tasks

Configuration, project planning, visualization and much more



### xEnergy configurator

The circuit breaker configurator is part of the xEnergy Configurator, and supports users in correctly configuring and ordering their Eaton products:

- Easy to operate
- Support of error-free selection and ordering of compact and open circuit breakers (NZM / IZMX)



### xSpider

xSpider is the next generation of software for the sizing and planning of low-voltage networks. It supports the design, selection and optimal configuration of the requisite switchgear. The graphic-oriented drafting software is easy to use and the corresponding database contains all relevant Eaton devices. The ability to select a circuit breaker based on the network diagram, and to examine the tripping characteristic directly, allows for a quick assessment of the selectivity and the required backup fuse. The integrated ArcRisk module, which is currently unique on the market, offers a quick and clear assessment of the arc fault risk in the planned low-voltage switchgear assembly.

## Product groups

### System overview – circuit breakers / switch-disconnectors

---

#### **Benefit from our portfolio of integrated accessories**

Assembly and function are identical for all accessories, independent of frame size. For example, the contact elements from the RMQ-Titan® range of control devices are used for the entire series of NZM circuit breakers. This reduces the number of separate product groups while simplifying the processes related to ordering and storage. The contact elements can simply be snapped on at the front.

The position determines the function: signaling contact or trip-indicating auxiliary contact. Shunt or under-voltage releases, which can also be combined with early-make auxiliary contacts (e.g. for interlocking or load-shedding circuits), offer a sophisticated approach to a wide range of applications.



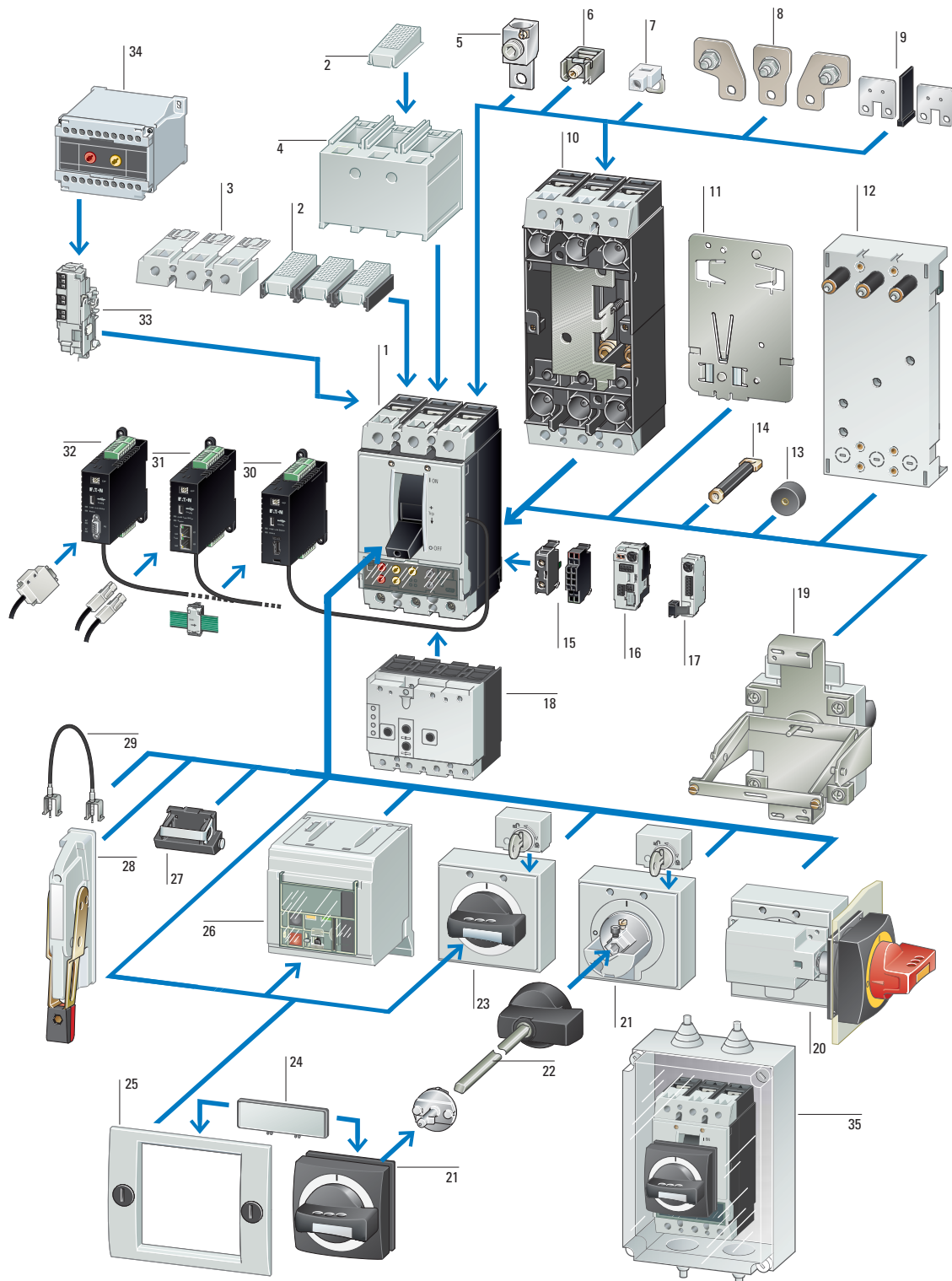

- |    |   |    |   |    |   |
|----|---|----|---|----|---|
| 1  | Switch-disconnector: circuit breaker; circuit breaker for North America; molded case switches for North America | 13 | Spacer  | 24 | External warning plate/marketing plate            |
| 2  | IP2X protection against finger-contact  | 14 | Connection on rear  | 25 | Insulating surround                               |
| 3  | Terminal cover, knockout  | 15 | Standard auxiliary contacts, trip-indicating auxiliary switches | 26 | Remote operator                                   |
| 4  | Terminal cover  | 16 | BSM interface module  | 27 | Toggle lever interlock device                     |
| 5  | Tunnel terminals  | 17 | Interface communication module for Modbus RTU                   | 28 | Side operator handle                              |
| 6  | Box terminals   | 18 | Residual-current protection device                              | 29 | Mechanical interlock                              |
| 7  | Control circuit terminal  | 19 | Rear operator   | 30 | Communication module for SmartWire-DT             |
| 8  | Connection width extension  | 20 | Main switch rotary handle for side panel mounting               | 31 | Communication module for Profibus DP              |
| 9  | Link kit  | 21 | Door coupling rotary handle                                     | 32 | Communication module for Ethernet-based protocols |
| 10 | Plug-in and withdrawable unit   | 22 | Extension shaft   | 33 | Voltage release/early-make auxiliary contact      |
| 11 | Adapter plate   | 23 | Rotary handle   | 34 | Delay unit for undervoltage releases              |
| 12 | Busbar adapter  |    |   | 35 | Ci insulated enclosure                            |

## Terminal types

The matching accessories for versatile applications

The terminal technology of the NZM circuit breakers enables you to address the specific requirements of your system in a flexible manner. Whether it is copper cables from 6 mm<sup>2</sup> to 300 mm<sup>2</sup> or aluminum cables, copper strips or copper bars – the NZM has the right solution for every type of connection. On the NZM2 and NZM3, for example, the box terminal can be opened upwards to simply swivel in the conductors. An IP20 (finger-safe) degree of protection can be achieved by means of accessories.

The heads of all the screws used in the circuit breakers, with the exception of the main terminal screws, have a plus-minus profile. This has the advantage that fast machine screwdrivers with standardized Pozidriv 2 drill bits can be used. Alternatively, a standard flat-bladed screwdriver may also be used. This applies to all fixing screws, auxiliary conductor terminals, flaps and covers as well as to all adjustment knobs.

Like the Pozidriv cross slot, the plus-minus slot can transmit a higher torque, which also makes it easier to center the tool while exerting less surface pressure. In addition, the plus-minus slot can be used for different types of tools and is particularly suitable for devices that require frequent maintenance.



### 1 Enhanced connectivity

The NZM circuit breakers and the PN and N switch-disconnectors can be connected by means of round conductors with or without cable lug, or by using laminated copper strips or copper bars. Another special feature: A narrow version of the cable lug is available to facilitate the connection of thick round conductors up to 300 mm<sup>2</sup>.



### 2 Screw terminal

Screw terminals are an inexpensive option for connecting cable lugs, perforated strips or copper bars. Our product portfolio of switch-gear accessories also includes the matching cable lugs. Furthermore, a stud version is offered which allows the simplest mounting of the cable lugs.



### 3 Box terminal for copper cable

If one or two flexible copper conductors or strips are to be directly connected, the box terminal ensures that the contact is safe. On the NZM2 and NZM3, the box terminal can be opened upwards for easy insertion of thick and rigid conductors, which makes connection particularly easy.



**Back-of-hand and finger protection**

Back-of-hand protection for cable lugs, box terminals or tunnel terminals can also be achieved by means of covers. IP2X finger protection, as required for main switches in accordance with IEC/EN 60204-1, can be quickly and easily implemented. The additional covers can be adapted to any cross section.

**Control-circuit terminals**

The control-circuit terminals are simply screwed on below the respective connection type. This makes it possible to quickly set up the taps for voltmeters, control transformers, undervoltage releases etc.



**4 Tunnel terminal for aluminum and copper cables**

The connection space of this special, tin-plated aluminum terminal is tunnel-shaped to reliably prevent the typical "flow behavior" of aluminum under high pressure. Depending on the model, up to six aluminum or copper conductors can be connected per phase.



**5 Connection expansion for additional conductors**

This allows for the connection of up to six conductors with cable lugs per phase. Auxiliary busbar systems are no longer required. Special covers for IP2X finger protection are available.



**6 Connection at rear**

This allows for the connection of rails or round conductors with cable lugs at the rear. The switch area, the cable connection area and the control area can be easily partitioned.



## Plug-in and withdrawable units

Safe to operate, with quick switch replacement

### Withdrawable units

In addition to the fixed installation type, the NZM3 and NZM4 circuit breakers are also available with plug-in and withdrawable units. You will benefit in more than one way: You will save money and time while eliminating sources of error. This makes it possible to react quickly to malfunctions or to replace the parts (e.g. as a result of an increase in the rated current), thereby avoiding long and expensive downtimes. The withdrawable units are operated using a uniform crank, which increases operational safety. This also makes it possible to put the switch into the test position for functional testing without any switching of the main contacts.

The position of the switch in the cassette can be detected by means of auxiliary contacts. This involves the following positions: connected/test position/disconnected. Even in the disconnected position, the switch is secured inside the cassette by means of a lock, to prevent it from falling out. Removal is only possible via manual release. In addition, the cassette can be locked in any position using a padlock. The standard terminals are compatible with the cassette base.







### Plug-in units

The plug-in technology allows for the quick and easy replacement of switches, without the need to switch off the system. The equal width of the fixed circuit breakers and the plug-in units simplifies the planning and design of the system. In addition to its isolating characteristics, the plug-in technology also facilitates the implementation of a clearly visible isolating distance.

The socket features the same terminals as the fixed switches, while the open plug-in contacts provide for IP2X finger protection. During dismantling, the circuit breaker will be automatically opened and moved to the tripped position for safety reasons. The control-circuit cable can be disconnected by means of a control-circuit plug unit. If the system is to be modified at a later date, the use of plug-in sockets for reserve outlets is recommended.



The plug-in technology is available for the NZM1, NZM2 and NZM3 models. The technology enables the safe and simple electrical isolation of the system during maintenance or replacement of the circuit breaker. An optional control-circuit plug unit is also available. This control-circuit plug unit makes it possible to test the control commands to/from the circuit breaker (shunt/undervoltage release, auxiliary contacts), even if it is not installed as part of the system. The socket has the same types of terminals as the main device. The NZM system accessories can be used without restriction.

## Multi-purpose adapter

For universal use and space-saving

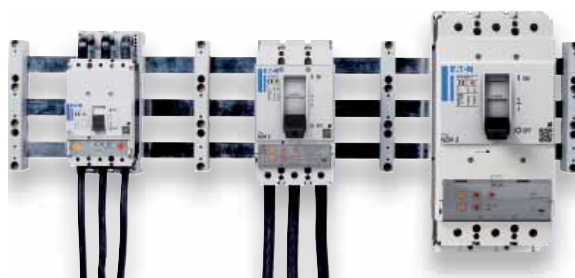

Thanks to their space-saving contacts, the busbar adapters can be installed even in applications where space is limited. They are suitable for universal use on any 60 mm busbar system. They are compatible with three different frame sizes, for 160 A, 250 A and 550 A.

## Releases and auxiliary contacts

Multi-purpose elements for easy handling

---



### Identical function and assembly of accessories

Assembly and function are identical for all accessories, independent of frame size. This makes handling considerably easier, enabling you to save time while reducing installation and maintenance costs.

### Push-in: Quick and safe connection

Both the new undervoltage and shunt releases up to 250 V and the relay modules now come with push-in terminals. This not only reduces the likelihood of errors, but also simplifies preparation and wiring while ensuring that your installation concept meets the highest safety requirements.



### The relay modules allow for automated signaling and responses

The relay modules are available for voltages up to 230 V AC and 24 V DC. Combinations with a shunt release or undervoltage release, or with an optional early-make auxiliary contact, are also possible. If you do not require any additional functions, configurations with two relays will suffice. The modules can be activated in the event of certain alerts, statuses or functions. In addition, it is also possible to control a remote operator or a motor-starter combination, or to set up alert and status signaling to the PLC.

### Simplified ordering thanks to the RMQ-Titan® contact elements

Like all standard auxiliary contacts in the 22-mm range, the trip-indicating switches use contact elements from the RMQ-Titan® range of control devices. The contact elements can simply be snapped on at the front. You can therefore choose from a wide range of auxiliary contacts, which are not only universally applicable, but also extremely robust and inexpensive. This simplifies the processes related to ordering and also reduces storage costs.

## The position determines the function

Whether it's signaling contacts or trip-indicating auxiliary contacts – all contacts as well as releases are also available with screw terminals. This ensures quick wiring of the circuit breakers and switch-disconnectors. The double contacts allow for twice as many auxiliary and signaling contacts in the same space. They are equipped with spring-loaded cage clamps.

## Flexible options for safety and locking tasks

Shunt or undervoltage releases are a sophisticated option for a wide range of applications – especially in combination with early-make auxiliary contacts, for example in interlocking or load-shedding circuits.



## Voltage releases for a variety of tasks

Voltage releases are available for the following applications: as undervoltage releases (with or without early-make auxiliary contacts) for main switch applications in accordance with EN 60204; as shunt releases for remote release; and as mesh-network circuit breakers for increased trip reliability.

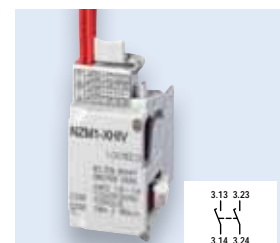

## A special case: Mesh-network circuit breakers

Eaton offers two options for mesh-network circuit breakers: a shunt release that functions as intended in the range from 10 % to 110 % of the control voltage, and a special shunt release that ensures trip reliability up to 12 hours after a power failure, provided it is used in conjunction with a capacitor unit.

## Variable operation

Toggle, turn, switch automatically

### Door-coupling rotary handles – ergonomic switching

Shafts that can be cut to different lengths allow for installation in control panels and enclosures with depths up to 600 mm. A cost-effective and easy-to-install option is also available for tight installations where the switch is located directly on the inside of the cover.

### Consistent and flexible

All door-coupling rotary handles have the same drilling template. This consistency contributes to a faster installation process. The switches can be installed either vertically or horizontally inside the control panel.



### Toggle or turn

The new circuit breaker series comes with the proven toggle lever as standard. The three switching positions ON, OFF and "TRIPPED" indicate the status of the device. For typical isolator applications where a voltage release is not required, Eaton offers the cost-effective PN switch-disconnector with the switch position indicators 0 and I. Depending on the individual requirements, the toggle mechanism can be converted to rotary action by means of a rotary drive. If a main switch or emergency power-off switch is used with a rotary handle, the latter can be locked with up to three padlocks. For the emergency power-off function, the rotary handles are also available in red/yellow.

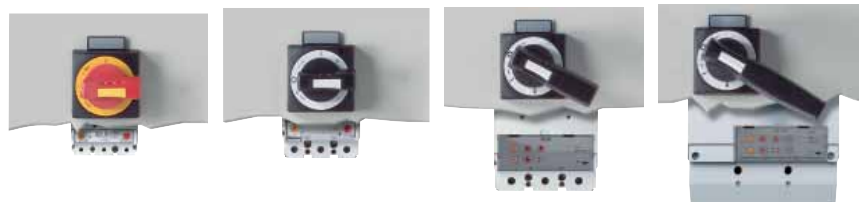

### Application-specific connections

For greater flexibility, the door-coupling rotary handle is available in various versions. The standard handle allows for automatic locking of the handle position, so that the control-panel doors can be conveniently closed even at different switching positions. The second version can be locked by means of padlocks, which will lock the doors automatically when closed. In the third version, an additional locking mechanism is available directly at the switch. In a large distribution board, for example, the switches can thus be individually locked. For the emergency-stop function, the handles are also available in contrasting red/yellow.

## Rotary handles

For switches and various types of interlocks



### Key locks for NZM circuit breakers

This function prevents the corresponding circuit breaker or switch-disconnector from being opened, and ensures the isolating condition for the OFF position in accordance with IEC/EN 60947-1. In this version, a cylinder lock combines with our proven rotary handles and door-coupling rotary handles and acts directly on the switch. To activate the lock, the circuit breaker or switch-disconnector must be first switched off. The safety key can only be removed in the "OFF" position. Once the machine has been switched off, operators can easily and safely work on it. They will also be able to lock multiple switches securely against one another.

## IEC and NA door-coupling rotary handles

Enhanced security by means of an additional handle on the switch



### Door-coupling rotary handle for North America in accordance with NFPA79 and UL508A

The North American user guidelines stipulate that the actuator must always be connected to the switch. This also applies when the control panel door is open. The door-coupling rotary handle with additional handle on the switch fulfills this condition. The handle complies with the latest NFPA79 and UL508A regulations for "deliberate action". Deliberate action is ensured by the fact that the additional handle must first be moved by approximately 20° before being simultaneously pressed (2) and turned (3) to turn on the switch. All essential safety features, such as the means of actuation, the switch position indication and the locking capability, are present twice, i.e. both on the outside of the door-coupling rotary handle and on the inside of the switch. The rotary handle for North American standards is available for frame sizes 1, 2, 3, and 4.

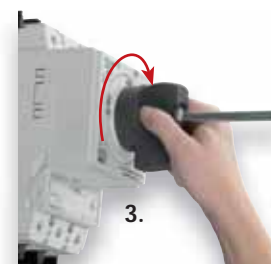
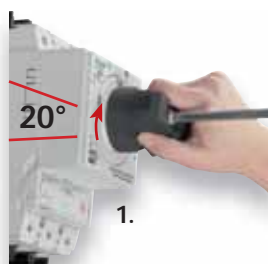

## Main switch assembly kits

### Operators and accessories

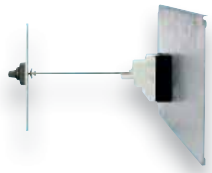

#### Flange operator

For applications up to 1,600 A, the flange operator allows the switch to be operated from the right or left hand side, as desired. With the optional addition of our mounting bracket for frame sizes 1 and 2, the space inside the control panel can be optimally used. The mounting plate can thus be used for other machine control elements.



#### Side-mounted handle

In UL applications, the side-mounted handle can be used for different frame sizes and for complete sets as well as for different degrees of protection and Bowden cable lengths. Caution: The side-mounted handle does not have IEC approval.



#### Rear operator

The innovative rear operators for circuit breakers and switch-disconnectors of frame sizes 1 and 2 offer an inexpensive and compact option for installing the switch and the door handle as a single unit in the enclosure doors or side panels. Typical applications include main switches with rated currents up to 250 A, for example in processing machines where space is limited (with or without emergency power-off function).

In addition to the optical benefits of this type of externally visible mounting, it also provides simple and fast access to the terminals, setting buttons, voltage releases and auxiliary contacts. Thanks to the UL/CSA approvals, the devices are suitable for global use, including North America. All circuit breakers and switch-disconnectors from the NZM1 and NZM2 range can be fitted with a rear operator. The compact mechanism and the solid rotary handle allow for quick installation and easy operation.



#### Accessories

A wide range of accessories, such as covers, locking devices, bezels and spacers etc., are available for all rotary handles and operators.

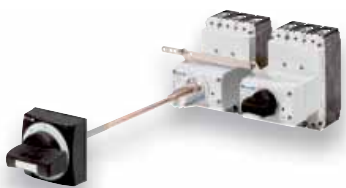
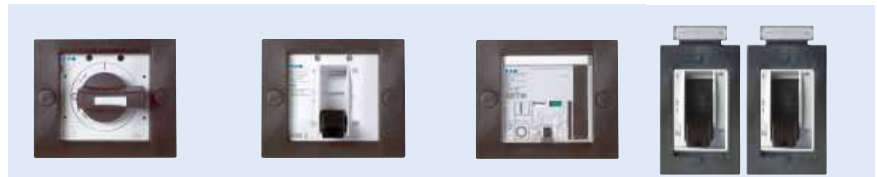

#### Paralling mechanism

The sophisticated paralling mechanism for disconnectors (PN) up to 630 A enables the simultaneous switching of multiple devices with just one movement. In a processing machine, for example, both the main and the auxiliary circuits can thus be safely switched at the same time.

## Remote operators

A consistent functional concept for simplified operation

It is in Eaton's nature to move things forward, as proven by our efforts to continuously optimize the accessories of the NZM product family. For example, the remote operators have now been equipped with a new control-circuit terminal, in which the plug can be firmly screwed to the pin header. An additional advantage: The terminal system comes with time-saving push-in terminals as a standard.



### The economic NZM2 remote operator for standard tasks with rated currents up to 300 A

The switching time of the new NZM2 remote operator is max. 170 ms, and it can therefore be used for automated or remote energy control in standard applications. The retractable mounting plate allows for quick checking of the built-in auxiliary contacts and voltage releases. Thanks to its slim design, the remote operator does not require any additional mounting surface. It has been equipped with a selector switch to ensure safe differentiation between the various operating positions. In addition, the switches can be securely locked in the 0 position by means of padlocks.

### The convenient remote operator for synchronization tasks of the NZM2 to NZM4 series

The spring-loaded operator enables fast switch-on times of 60 ms or 100 ms, making it suitable for use with synchronization tasks. Short function sequences and the small number of parts ensure a high degree of stability and a long service life. The possibility to seal the auto function and the option of locking the remote operator with a padlock are further important contributions to safety.



## Mechanical interlocks With Bowden cable

Mechanical lock modules allow for the locking of two or three switches (of identical or different frame sizes), which can either be equipped with rotary handles (a) or remote operators (b). The use of the Bowden cable makes it possible to mount the switches freely in various positions. The switches may be arranged up to 1 m apart – for example in separate enclosures.

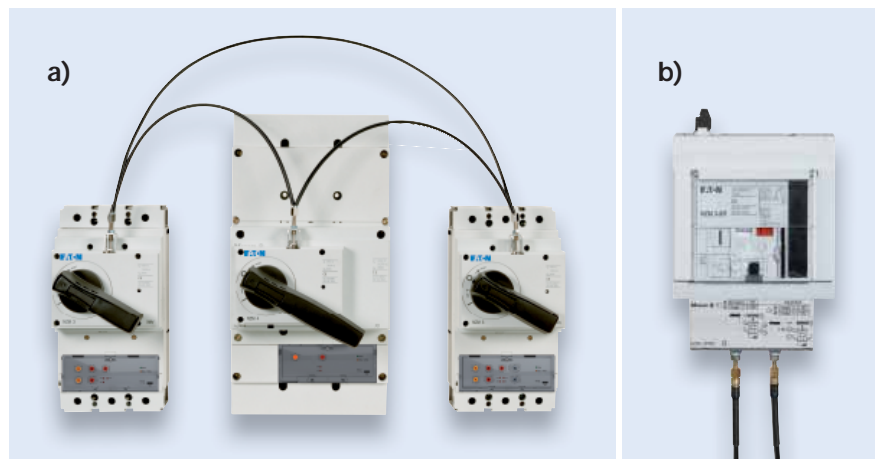



## Mounting tools

Save time and money



### Spacers

All switches, including their accessories, have been designed on a grid with the spacer as the base unit. Different switch depths can be easily compensated with the quick addition of inexpensive spacers. If the circuit breaker is to be externally operated, this option offers a cost-effective alternative to the door-coupling rotary handle with shaft extension. This brand new technology thus results in significant time and cost savings.

### Bezels

Whether the switch is equipped with a toggle lever, a rotary operator or a remote operator, the bezel will always fit. There is thus no need to keep various types of bezels in stock. This is a low-cost option for operating switches from the outside when the control panel door is closed. The bezel has IP40 degree of protection, and the inscription labels can be simply snapped on.

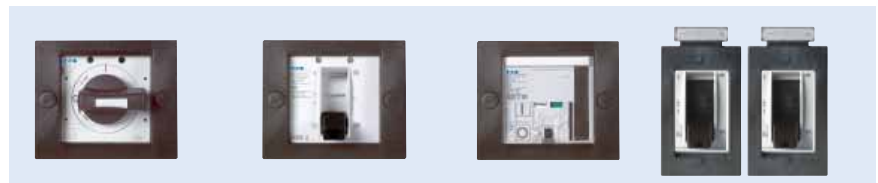

### Top-hat rail mounting

The top-hat rail mounting saves time thanks to the use of clip plates for NZM1 and NZM2. Simply attach the clip plate to the circuit breaker at the rear and then clip it onto the top-hat rail. A tiresome drilling of holes in the mounting plate is no longer necessary. A special advantage of the small NZM1: Thanks to the standardized front dimensions, add-on configurations (e.g. with narrow circuit breakers) are possible inside the distribution board.

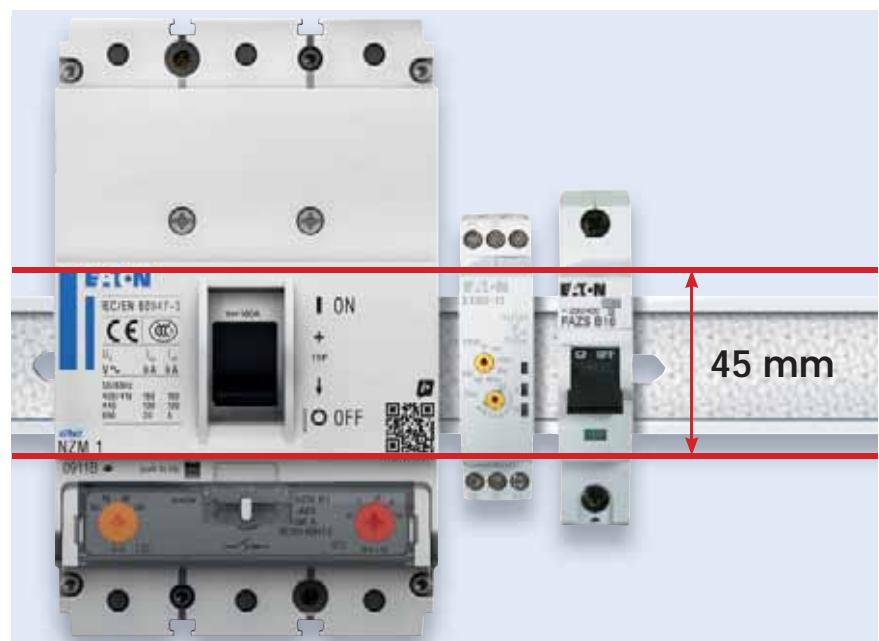

# 1.1

## Compact circuit breakers, switch disconnectors

Circuit breakers, thermomagnetic releases, 3 pole  
NZM...A

Switching capacity 400/415V 50/60 Hz	Rated current = Rated uninterrupted current	Setting range		Fixed mounting with screw terminals	
		Overload releases	Short-circuit releases Non-delayed	Part no.	Article no.
$I_{cu}$ kA	$I_n = I_u$ A	$I_r = I_n \times \dots$ A	$I_s = I_n \times \dots$		

### System and cable protection

- IEC/EN 60947-2

#### Basic switching capacity

1230PIC-785 Symbolphoto



25	20	15 - 20	350 A fixed	Screw terminals as accessories	
	25	20 - 25	350 A fixed		
	32	25 - 32	350 A fixed		
	40	32 - 40	8 - 10		
	50	40 - 50	6 - 10		
	63	50 - 63	6 - 10		
	80	63 - 80	6 - 10		
	100	80 - 100	6 - 10		
	125	100 - 125	6 - 10		
	160	125 - 160	1280 A fixed		

1230PIC-802 Symbolphoto



125	100 - 125	6 - 10	NZMB2-A125	259087
160	125 - 160	6 - 10	NZMB2-A160	259088
200	160 - 200	6 - 10	NZMB2-A200	259089
250	200 - 250	6 - 10	NZMB2-A250	259090
300	240 - 300	5 - 8.3	NZMB2-A300	107518

#### Comfort switching capacity

1230PIC-785 Symbolphoto



36	20	15 - 20	350 A fixed	Screw terminals as accessories	
	25	20 - 25	350 A fixed		
	32	25 - 32	350 A fixed		
	40	32 - 40	8 - 10		
	50	40 - 50	6 - 10		
	63	50 - 63	6 - 10		
	80	63 - 80	6 - 10		
	100	80 - 100	6 - 10		
	125	100 - 125	6 - 10		
	160	125 - 160	1280 A fixed		

1230PIC-802 Symbolphoto



125	100 - 125	6 - 10	NZMC2-A125	271420
160	125 - 160	6 - 10	NZMC2-A160	271421
200	160 - 200	6 - 10	NZMC2-A200	271422
250	200 - 250	6 - 10	NZMC2-A250	271423
300	240 - 300	5 - 8.3	NZMC2-A300	107519

1230PIC-703 Symbolphoto



250	200 - 250	6 - 10	NZMC3-A250	109664
320	250 - 320	6 - 10	NZMC3-A320	109665
400	320 - 400	6 - 10	NZMC3-A400	109666
500	400 - 500	6 - 10	NZMC3-A500	109667

# Compact circuit breakers, switch disconnectors

Circuit breakers, thermomagnetic releases, 3 pole  
NZM...A

# 1.1

## Fixed mounting with box terminals

Part no. Article no.

## Plug-in/withdrawable units

Part no. Article no. Std. pack

Order base separately

For further terminal types  
see accessories

NZMB1-A20	280987	NZMB1-A20-SVE	112733	1 Off
NZMB1-A25	280988	NZMB1-A25-SVE	112734	
NZMB1-A32	280989	NZMB1-A32-SVE	112735	
NZMB1-A40	259075	NZMB1-A40-SVE	112703	
NZMB1-A50	259076	NZMB1-A50-SVE	112704	
NZMB1-A63	259077	NZMB1-A63-SVE	112705	
NZMB1-A80	259078	NZMB1-A80-SVE	112706	
NZMB1-A100	259079	NZMB1-A100-SVE	112707	
NZMB1-A125	259080	NZMB1-A125-SVE	112708	
NZMB1-A160	281230	-		

Terminals as accessory		NZMB2-A125-SVE	113192	
NZMB2-A160-BT	110215	NZMB2-A160-SVE	113193	
NZMB2-A200-BT	110216	NZMB2-A200-SVE	113194	
NZMB2-A250-BT	110217	NZMB2-A250-SVE	113195	
NZMB2-A300-BT	110214	-		

NZMC1-A20	283293	NZMC1-A20-SVE	112753	1 Off
NZMC1-A25	283294	NZMC1-A25-SVE	112754	
NZMC1-A32	283295	NZMC1-A32-SVE	112755	
NZMC1-A40	271392	NZMC1-A40-SVE	112737	
NZMC1-A50	271393	NZMC1-A50-SVE	112738	
NZMC1-A63	271394	NZMC1-A63-SVE	112739	
NZMC1-A80	271395	NZMC1-A80-SVE	112740	
NZMC1-A100	271396	NZMC1-A100-SVE	112741	
NZMC1-A125	271397	NZMC1-A125-SVE	112742	
NZMC1-A160	283296	-		



Terminals as accessory		NZMC2-A125-SVE	113219	1 Off
NZMC2-A160-BT	110219	NZMC2-A160-SVE	113220	
NZMC2-A200-BT	110280	NZMC2-A200-SVE	113221	
NZMC2-A250-BT	110281	NZMC2-A250-SVE	113222	
NZMC2-A300-BT	110218	-		

Terminals as accessory		-		
NZMC3-A320-BT	110299	NZMC3-A320-SVE	168450	
-		NZMC3-A320-AVE	113509	
NZMC3-A400-BT	110300	NZMC3-A400-SVE	168451	
-		NZMC3-A400-AVE	113510	
NZMC3-A500-BT	110301	NZMC3-A500-SVE	168452	
-		NZMC3-A500-AVE	113511	

# 1.1

## Compact circuit breakers, switch disconnectors

Circuit breakers, thermomagnetic releases, 3 pole  
NZM...A

Switching capacity 400/415V 50/60 Hz	Rated current = Rated uninterrupted current	Setting range		Fixed mounting with screw terminals	
		Overload releases	Short-circuit releases Non-delayed	Part no.	Article no.
$I_{cu}$ kA	$I_n = I_u$ A	$I_r = I_n \times \dots$ A	$I_s = I_n \times \dots$		
					

### System and cable protection

- IEC/EN 60947-2

#### Normal switching capacity

1230PIC-785 Symbolphoto



50	20	15 - 20	350 A fixed	Screw terminals as accessories	
	25	20 - 25	350 A fixed		
	32	25 - 32	350 A fixed		
	40	32 - 40	8 - 10		
	50	40 - 50	6 - 10		
	63	50 - 63	6 - 10		
	80	63 - 80	6 - 10		
	100	80 - 100	6 - 10		
	125	100 - 125	6 - 10		
	160	125 - 160	1280 A fixed		

1230PIC-802 Symbolphoto



125	100 - 125	6 - 10	NZMN2-A125	259091
160	125 - 160	6 - 10	NZMN2-A160	259092
200	160 - 200	6 - 10	NZMN2-A200	259093
250	200 - 250	6 - 10	NZMN2-A250	259094
300	240 - 300	5 - 8.3	NZMN2-A300	107580

1230PIC-703 Symbolphoto



250	125 - 250	6 - 10	NZMN3-A250	109668
320	250 - 320	6 - 10	NZMN3-A320	109669
400	320 - 400	6 - 10	NZMN3-A400	109670
500	400 - 500	6 - 10	NZMN3-A500	109671

# Compact circuit breakers, switch disconnectors

Circuit breakers, thermomagnetic releases, 3 pole  
NZM...A

# 1.1

## Fixed mounting with box terminals

Part no. Article no.

## Plug-in/withdrawable units

Part no. Article no. Std. pack

Order base separately

For further terminal types  
see accessories

NZMN1-A20	281231	NZMN1-A20-SVE	112776	1 Off
NZMN1-A25	281232	NZMN1-A25-SVE	112777	
NZMN1-A32	281233	NZMN1-A32-SVE	112778	
NZMN1-A40	259081	NZMN1-A40-SVE	112757	
NZMN1-A50	259082	NZMN1-A50-SVE	112758	
NZMN1-A63	259083	NZMN1-A63-SVE	112759	
NZMN1-A80	259084	NZMN1-A80-SVE	112760	
NZMN1-A100	259085	NZMN1-A100-SVE	112761	
NZMN1-A125	259086	NZMN1-A125-SVE	112762	
NZMN1-A160	281234	-		

Terminals as accessory		NZMN2-A125-SVE	113243	
NZMN2-A160-BT	110283	NZMN2-A160-SVE	113244	
NZMN2-A200-BT	110284	NZMN2-A200-SVE	113245	
NZMN2-A250-BT	110285	NZMN2-A250-SVE	113246	
NZMN2-A300-BT	110282	-		



Terminals as accessory		-		
NZMN3-A320-BT	110302	NZMN3-A320-SVE	168486	
-		NZMN3-A320-AVE	110858	
NZMN3-A400-BT	110303	NZMN3-A400-SVE	168487	
-		NZMN3-A400-AVE	110859	
NZMN3-A500-BT	110304	NZMN3-A500-SVE	168488	
-		NZMN3-A500-AVE	110860	



# 1.1

## Compact circuit breakers, switch disconnectors

Circuit breakers, thermomagnetic releases, 3 pole  
NZM...A

Switching capacity 400/415V 50/60 Hz	Rated current = Rated uninterrupted current	Setting range		Fixed mounting with screw terminals	
		Overload releases	Short-circuit releases Non-delayed	Part no.	Article no.
$I_{cu}$ kA	$I_n = I_u$ A	$I_r = I_n \times \dots$ A	$I_s = I_n \times \dots$		
					

### System and cable protection

- IEC/EN 60947-2

#### Strong switching capacity

1230PIC-785 Symbolphoto



70	20	15 - 20	350 A fixed	Screw terminals as accessories	
	25	20 - 25	350 A fixed		
	32	25 - 32	350 A fixed		
	40	32 - 40	8 - 10		
	50	40 - 50	6 - 10		
	63	50 - 63	6 - 10		
	80	63 - 80	6 - 10		
	100	80 - 100	6 - 10		
	125	100 - 125	6 - 10		
	160	125 - 160	1280 A fixed		

1230PIC-802 Symbolphoto



20	15 - 20	350 A fixed	NZMS2-A20	192020
32	25 - 32	350 A fixed	NZMS2-A32	192022
40	32 - 40	8 - 10	NZMS2-A40	109958
50	40 - 50	6 - 10	NZMS2-A50	109959
63	50 - 63	6 - 10	NZMS2-A63	109960
80	63 - 80	6 - 10	NZMS2-A80	109961
100	80 - 100	6 - 10	NZMS2-A100	109962
125	100 - 125	6 - 10	NZMS2-A125	109963
160	125 - 160	6 - 10	NZMS2-A160	109964
200	160 - 200	6 - 10	NZMS2-A200	109965
250	200 - 250	6 - 10	NZMS2-A250	109966
300	150 - 300	5 - 8.3	NZMS2-A300	109967

1230PIC-703 Symbolphoto



250	200 - 250	6 - 10	NZMS3-A250	192023
320	250 - 320	6 - 10	NZMS3-A320	192024
400	320 - 400	6 - 10	NZMS3-A400	192025
500	400 - 500	6 - 10	NZMS3-A500	192026

# Compact circuit breakers, switch disconnectors

Circuit breakers, thermomagnetic releases, 3 pole  
NZM...A

# 1.1

**Fixed mounting with box terminals**  
Part no.

Article no.

**Plug-in/withdrawable units**  
Part no.

Article no.

Std. pack

Order base separately

For further terminal types  
see accessories

NZMS1-A20	109933		NZMS1-A20-SVE	112780	1 Off
NZMS1-A25	109934		NZMS1-A25-SVE	112781	
NZMS1-A32	109935		NZMS1-A32-SVE	112782	
NZMS1-A40	109936		NZMS1-A40-SVE	112783	
NZMS1-A50	109937		NZMS1-A50-SVE	112784	
NZMS1-A63	109938		NZMS1-A63-SVE	112785	
NZMS1-A80	109939		NZMS1-A80-SVE	112786	
NZMS1-A100	109940		NZMS1-A100-SVE	112787	
NZMS1-A125	109941		NZMS1-A125-SVE	112788	
NZMS1-A160	109942		-		



Terminals as accessory	_____		-		
	_____		-		
	_____		NZMS2-A40-SVE	113283	
	_____		NZMS2-A50-SVE	113284	
	_____		NZMS2-A63-SVE	113285	
	_____		NZMS2-A80-SVE	113286	
	_____		NZMS2-A100-SVE	113287	
	_____		NZMS2-A125-SVE	113288	
	_____		NZMS2-A160-SVE	113289	
	_____		NZMS2-A200-SVE	113290	
	_____	NZMS2-A250-SVE	113291		
	_____	-			

Terminals as accessory	_____	-		
	_____	-		
	_____	-		
	_____	-		

# 1.1

## Compact circuit breakers, switch disconnectors

Circuit breakers, thermomagnetic releases, 3 pole  
NZM...A

Switching capacity 400/415V 50/60 Hz	Rated current = Rated uninterrupted current	Setting range		Fixed mounting with screw terminals	
		Overload releases	Short-circuit releases Non-delayed	Part no.	Article no.
$I_{cu}$ kA	$I_n = I_u$ A	$I_r = I_n \times \dots$ A	$I_s = I_n \times \dots$		
					

### System and cable protection

- IEC/EN 60947-2

#### High switching capacity

1230PIC-785 Symbolphoto



100	20	15 - 20	350 A fixed	Screw terminals as accessories	
	25	20 - 25	350 A fixed		
	32	25 - 32	350 A fixed		
	40	32 - 40	8 - 10		
	50	40 - 50	6 - 10		
	63	50 - 63	6 - 10		
	80	63 - 80	6 - 10		
	100	80 - 100	6 - 10		
	125	100 - 125	6 - 10		
	160	125 - 160	1280 A fixed		

1230PIC-802 Symbolphoto



150	20	15 - 20	350 A fixed	NZMH2-A20	281281
	25	20 - 25	350 A fixed	NZMH2-A25	281282
	32	25 - 32	350 A fixed	NZMH2-A32	281283
	40	32 - 40	8 - 10	NZMH2-A40	259095
	50	40 - 50	6 - 10	NZMH2-A50	259096
	63	50 - 63	6 - 10	NZMH2-A63	259097
	80	63 - 80	6 - 10	NZMH2-A80	259098
	100	80 - 100	6 - 10	NZMH2-A100	259099
	125	100 - 125	6 - 10	NZMH2-A125	259100
	160	125 - 160	6 - 10	NZMH2-A160	259101
	200	160 - 200	6 - 10	NZMH2-A200	259102
	250	200 - 250	6 - 10	NZMH2-A250	259103
	300	240 - 300	5 - 8.3	NZMH2-A300	107581

1230PIC-703 Symbolphoto



	250	200 - 250	6 - 10	NZMH3-A250	109672
	320	250 - 320	6 - 10	NZMH3-A320	109673
	400	400 - 500	6 - 10	NZMH3-A400	109674
	500	400 - 500	6 - 10	NZMH3-A500	109675



# Compact circuit breakers, switch disconnectors

Circuit breakers, thermomagnetic releases, 3 pole  
NZM...A

# 1.1

### Fixed mounting with box terminals

Part no. Article no.

### Plug-in/withdrawable units

Part no. Article no. Std. pack

Order base separately

For further terminal types  
see accessories

NZMH1-A20	284376
NZMH1-A25	284377
NZMH1-A32	284378
NZMH1-A40	284379
NZMH1-A50	284410
NZMH1-A63	284411
NZMH1-A80	284412
NZMH1-A100	284413
NZMH1-A125	284414
NZMH1-A160	284415



NZMH1-A20-SVE	112795	1 Off
NZMH1-A25-SVE	112796	
NZMH1-A32-SVE	112797	
NZMH1-A40-SVE	112798	
NZMH1-A50-SVE	112799	
NZMH1-A63-SVE	112800	
NZMH1-A80-SVE	112801	
NZMH1-A100-SVE	112802	
NZMH1-A125-SVE	112803	
-	-	

NZMH2-A20-BT	110296
NZMH2-A25-BT	110297
NZMH2-A32-BT	110298
NZMH2-A40-BT	110287
NZMH2-A50-BT	110288
NZMH2-A63-BT	110289
NZMH2-A80-BT	110290
NZMH2-A100-BT	110291
NZMH2-A125-BT	110292
NZMH2-A160-BT	110293
NZMH2-A200-BT	110294
NZMH2-A250-BT	110295
NZMH2-A300-BT	110286



NZMH2-A20-SVE	113351
NZMH2-A25-SVE	113352
NZMH2-A32-SVE	113353
NZMH2-A40-SVE	113328
NZMH2-A50-SVE	113329
NZMH2-A63-SVE	113330
NZMH2-A80-SVE	113331
NZMH2-A100-SVE	113332
NZMH2-A125-SVE	113333
NZMH2-A160-SVE	113334
NZMH2-A200-SVE	113335
NZMH2-A250-SVE	113336
-	-

Terminals as accessory	
NZMH3-A320-BT	110305
-	
NZMH3-A400-BT	110306
-	
NZMH3-A500-BT	110307
-	





-	
NZMH3-A320-SVE	168913
NZMH3-A320-AVE	110861
NZMH3-A400-SVE	168914
NZMH3-A400-AVE	110862
NZMH3-A500-SVE	168915
NZMH3-A500-AVE	110863

# 1.1

## Compact circuit breakers, switch disconnectors

Circuit breakers, thermomagnetic releases, 3 pole  
NZM...M

### Fixed mounting with screw terminals

Switching capacity 400/415V 50/60 Hz	Rated current = Rated uninterrupted current	Setting range		Rated operational power 50/60 Hz 400 V P kW	Rated operational current 400 V $I_e$ A	Part no.	Article no.
		Overload releases	Short-circuit releases Non-delayed				
$I_{cu}$ kA	$I_n = I_u$ A	$I_r = I_n \times \dots$ A	$I_s = I_n \times \dots$				
							

### Motor protection

- NZM...1-M...: with phase-failure sensitivity
- Tripping class 10 A
- IEC/EN 60947-2

### High switching capacity

1230PIC-786 Symbolphoto



25	40	32 - 40	8 - 14	18.5	36	Screw terminals as accessories	
	50	40 - 50	8 - 14	22	41		
	63	40 - 63	8 - 14	30	55		
	80	63 - 80	8 - 14	37	68		
	100	80 - 100	8 - 12.5	45	81		

1230PIC-803 Symbolphoto



125	100 - 125	8 - 14	55	99	NZMB2-M125	265715
160	125 - 160	8 - 14	75	134	NZMB2-M160	265716
200	160 - 200	8 - 14	110	196	NZMB2-M200	265717

### Comfort switching capacity

1230PIC-786 Symbolphoto



36	40	32 - 40	8 - 14	18.5	36	Screw terminals as accessories	
	50	40 - 50	8 - 14	22	41		
	63	50 - 63	8 - 14	30	55		
	80	63 - 80	8 - 14	37	68		
	100	80 - 100	8 - 12.5	45	99		

1230PIC-803 Symbolphoto



125	100 - 125	8 - 14	55	99	NZMC2-M125	271424
160	125 - 160	8 - 14	75	134	NZMC2-M160	271425
200	160 - 200	8 - 14	110	196	NZMC2-M200	271426

# Compact circuit breakers, switch disconnectors

# 1.1

## Circuit breakers, thermomagnetic releases, 3 pole NZM...M

Fixed mounting with box terminals  
Part no.

Article no.

Plug-in units  
Part no.

Article no.

Std. pack

Order base separately

For further terminal types  
see accessories

NZMB1-M40	265710
NZMB1-M50	265711
NZMB1-M63	265712
NZMB1-M80	265713
NZMB1-M100	265714



NZMB1-M40-SVE	112709	1 Off
NZMB1-M50-SVE	112720	
NZMB1-M63-SVE	112721	
NZMB1-M80-SVE	112722	
NZMB1-M100-SVE	112723	

NZMB2-M125-BT	115260
Terminals as accessory	



NZMB2-M125-SVE	113196
NZMB2-M160-SVE	113197
NZMB2-M200-SVE	113198

NZMC1-M40	271398
NZMC1-M50	271399
NZMC1-M63	271400
NZMC1-M80	271401
NZMC1-M100	271402



NZMC1-M40-SVE	112743	1 Off
NZMC1-M50-SVE	112744	
NZMC1-M63-SVE	112745	
NZMC1-M80-SVE	112746	
NZMC1-M100-SVE	112747	

Terminals as accessory	





NZMC2-M125-SVE	113223
NZMC2-M160-SVE	113224
NZMC2-M200-SVE	113225

# 1.1

## Compact circuit breakers, switch disconnectors

Circuit breakers, thermomagnetic releases, 3 pole  
NZM...M

Fixed mounting with screw terminals

Switching capacity 400/415V 50/60 Hz	Rated current = Rated uninterrupted current	Setting range		Rated operational power 50/60 Hz 400 V P kW	Rated operational current 400 V I <sub>e</sub> A	Part no.	Article no.
		Overload releases	Short-circuit releases Non-delayed				
I <sub>cu</sub> kA	I <sub>n</sub> = I <sub>u</sub> A	I <sub>r</sub> = I <sub>n</sub> x... A	I <sub>s</sub> = I <sub>n</sub> x... A				
							

### Motor protection

- NZM...1-M...: with phase-failure sensitivity
- Tripping class 10 A
- IEC/EN 60947-2

### Normal switching capacity

50	40	32 - 40	8 - 14	18.5	36	Screw terminals as accessories	
	50	40 - 50	8 - 14	22	41		
	63	50 - 63	8 - 14	30	55		
	80	63 - 80	8 - 14	37	68		
	100	80 - 100	8 - 12.5	45	99		
	125	100 - 125	8 - 14	55	99	NZMN2-M125	265723
	160	125 - 160	8 - 14	75	134	NZMN2-M160	265724
	200	160 - 200	8 - 14	110	196	NZMN2-M200	265725

1230PIC-786 Symbolphoto



1230PIC-803 Symbolphoto



### Strong switching capacity

70	20	15 - 20	350 A fixed	7.5	16	NZMS2-M20	109968
	25	20 - 25	350 A fixed	11	21.7	NZMS2-M25	109969
	32	25 - 32	350 A fixed	15	29.3	NZMS2-M32	109970
	40	32 - 40	8 - 14	18.5	36	NZMS2-M40	109971
	50	40 - 50	8 - 14	22	41	NZMS2-M50	109972
	63	50 - 63	8 - 14	30	55	NZMS2-M63	109973
	80	63 - 80	8 - 14	37	68	NZMS2-M80	109974
	100	80 - 100	8 - 14	55	81	NZMS2-M100	109975
	125	100 - 125	8 - 14	55	100	NZMS2-M125	109976
	160	125 - 160	8 - 14	75	134	NZMS2-M160	109977
	200	160 - 200	8 - 14	110	196	NZMS2-M200	109978

1230PIC-803 Symbolphoto



# Compact circuit breakers, switch disconnectors

# 1.1

## Circuit breakers, thermomagnetic releases, 3 pole NZM...M

Fixed mounting with box terminals  
Part no.

Article no.

Plug-in units  
Part no.

Article no.

Std. pack

Order base separately

For further terminal types  
see accessories

NZMN1-M40	265718
NZMN1-M50	265719
NZMN1-M63	265720
NZMN1-M80	265721
NZMN1-M100	265722



NZMN1-M40-SVE	112763	1 Off
NZMN1-M50-SVE	112764	
NZMN1-M63-SVE	112765	
NZMN1-M80-SVE	112766	
NZMN1-M100-SVE	112767	

Terminals as accessory	_____
	_____



NZMN2-M125-SVE	113250
NZMN2-M160-SVE	113251
NZMN2-M200-SVE	113252

Terminals as accessory	_____
	_____
	_____
	_____
	_____
	_____
	_____
	_____
	_____
	_____





NZMS2-M20-SVE	113293	1 Off
NZMS2-M25-SVE	113294	
NZMS2-M32-SVE	113295	
NZMS2-M40-SVE	113296	
NZMS2-M50-SVE	113297	
NZMS2-M63-SVE	113298	
NZMS2-M80-SVE	113299	
NZMS2-M100-SVE	113300	
NZMS2-M125-SVE	113301	
NZMS2-M160-SVE	113302	
NZMS2-M200-SVE	113303	

# 1.1

## Compact circuit breakers, switch disconnectors

Circuit breakers, thermomagnetic releases, 3 pole  
NZM...M

Switching capacity 400/415V 50/60 Hz	Rated current = Rated uninterrupted current	Setting range		Rated operational power AC-3 50/60 Hz 400 V P kW	Rated operational current 400 V $I_e$ A	Part no.	Article no.
		Overload releases	Short-circuit releases Non-delayed				
$I_{cu}$ kA	$I_n = I_u$ A	$I_r = I_n \times \dots$ A	$I_j = I_n \times \dots$				
							

### Motor protection

- NZM...1-M...: with phase-failure sensitivity
- Tripping class 10 A
- IEC/EN 60947-2

### High switching capacity

1230PIC-786 Symbolphoto



100	40	32-40	8 - 14	18.5	36	Screw terminals as accessories	
	50	40-50	8 - 14	22	41		
	63	50-63	8 - 14	30	55		
	80	63-80	8 - 14	37	68		
	100	80-100	8 - 12.5	45	99		

1230PIC-803 Symbolphoto



25	20-25	350 A fixed	11	21.7	NZMH2-M25	281300
32	25-32	350 A fixed	15	29.3	NZMH2-M32	281301
40	32-40	8 - 14	18.5	36	NZMH2-M40	281302
50	40-50	8 - 14	22	41	NZMH2-M50	281303
63	50-63	8 - 14	30	55	NZMH2-M63	281304
80	63-80	8 - 14	37	68	NZMH2-M80	281305
100	80-100	8 - 14	45	99	NZMH2-M100	281306
125	100-125	8 - 14	55	99	NZMH2-M125	281307
160	125-160	8 - 14	75	134	NZMH2-M160	281308
200	160-200	8 - 14	110	196	NZMH2-M200	281309

# Compact circuit breakers, switch disconnectors

# 1.1

## Circuit breakers, thermomagnetic releases, 3 pole NZM...M

**Fixed mounting with box terminals**  
Part no.

Article no.

**Plug-in units**  
Part no.

Article no.

Std. pack

Order base separately

For further terminal types  
see accessories

NZMH1-M40	115450		NZMH1-M40-SVE	115790	1 Off
NZMH1-M50	115451		NZMH1-M50-SVE	115791	
NZMH1-M63	115452		NZMH1-M63-SVE	115792	
NZMH1-M80	115453		NZMH1-M80-SVE	115793	
NZMH1-M100	115454		NZMH1-M100-SVE	115794	

Terminals as accessory

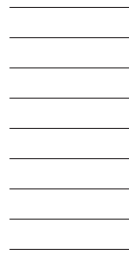

NZMH2-M25-SVE	113355
NZMH2-M32-SVE	113356
NZMH2-M40-SVE	113357
NZMH2-M50-SVE	113358
NZMH2-M63-SVE	113359
NZMH2-M80-SVE	113360
NZMH2-M100-SVE	113361
NZMH2-M125-SVE	113362
NZMH2-M160-SVE	113363
NZMH2-M200-SVE	113364

# 1.2

## Compact circuit breakers, switch disconnectors

Circuit breakers, magnetic short-circuit releases, 3 pole  
NZM...S

Switching capacity 400/415V 50/60 Hz	Rated current = Rated uninterrupted current	Setting range Short-circuit releases Non-delayed	Rated operational power AC-3 50/60 Hz 400 V P kW	Rated operational current AC-3 50/60 Hz 400 V I <sub>e</sub> A	Fixed mounting with screw terminals	
					Part no.	Article no.
	I <sub>cu</sub> kA	I <sub>n</sub> = I <sub>u</sub> A	I <sub>1</sub> = I <sub>n</sub> × ...			



### Short-circuit protection

Motor protection in conjunction with overload relay

- With short-circuit releases
- Without overload releases I<sub>r</sub> = I<sub>n</sub> × ...
- IEC/EN 60947-2

### Basic switching capacity

1230PIC-787 Symbolphoto



25	40	8 - 14	18.5	36	Screw terminals as accessories	
	50	8 - 14	22	41		
	63	8 - 14	30	55		
	80	8 - 14	37	68		
	100	8 - 12.5	45	81		

1230PIC-804 Symbolphoto



125	8 - 14	45	99	NZMB2-S125	265736
160	8 - 14	75	134	NZMB2-S160	265737
200	8 - 12.5	110	196	NZMB2-S200	265738

### Comfort switching capacity

1230PIC-787 Symbolphoto



36	40	8 - 14	18.5	36	Screw terminals as accessories	
	50	8 - 14	22	41		
	63	8 - 14	30	55		
	80	8 - 14	37	68		
	100	8 - 12.5	45	81		

1230PIC-804 Symbolphoto



125	8 - 14	45	99	NZMC2-S125	271427
160	8 - 14	75	134	NZMC2-S160	271428
200	8 - 12.5	110	196	NZMC2-S200	271429

1230PIC-881 Symbolphoto



250	8 - 14	132	231	NZMC3-S250	109676
320	8 - 14	160	279	NZMC3-S320	109677
400	7 - 12.5	200	349	NZMC3-S400	109678
500	6 - 10	250	437	NZMC3-S500	109679



# Compact circuit breakers, switch disconnectors

# 1.2

## Circuit breakers, magnetic short-circuit releases, 3 pole NZM...S

### Fixed mounting with box terminals

Part no. Article no.

### Plug-in/withdrawable units

Part no. Article no. Std. pack

Order base separately

For further terminal types  
see accessories

NZMB1-S40	265726		NZMB1-S40-SVE	112724	1 Off
NZMB1-S50	265727		NZMB1-S50-SVE	112725	
NZMB1-S63	265728		NZMB1-S63-SVE	112726	
NZMB1-S80	265729		NZMB1-S80-SVE	112727	
NZMB1-S100	265730		NZMB1-S100-SVE	112728	

Terminals as accessory	_____		NZMB2-S125-SVE	113199	
	_____		NZMB2-S160-SVE	113200	
	_____		NZMB2-S200-SVE	113201	

NZMC1-S40	271403		NZMC1-S40-SVE	112748	1 Off
NZMC1-S50	271404		NZMC1-S50-SVE	112749	
NZMC1-S63	271405		NZMC1-S63-SVE	112750	
NZMC1-S80	271406		NZMC1-S80-SVE	112751	
NZMC1-S100	271407		NZMC1-S100-SVE	112752	

Terminals as accessory	_____		NZMC2-S125-SVE	113226	
	_____		NZMC2-S160-SVE	113227	
	_____		NZMC2-S200-SVE	113228	

Terminals as accessory	_____		NZMC3-S250-SVE	168453	
	_____		NZMC3-S250-AVE	113512	
	_____		NZMC3-S320-SVE	168454	
	_____		NZMC3-S320-AVE	113513	
	_____		NZMC3-S400-SVE	168455	
	_____		NZMC3-S400-AVE	113514	
	_____		NZMC3-S500-SVE	168456	
	_____	NZMC3-S500-AVE	113515		

# 1.2

## Compact circuit breakers, switch disconnectors

Circuit breakers, magnetic short-circuit releases, 3 pole  
NZM...S

Switching capacity 400/415V 50/60 Hz	Rated current = Rated uninterrupted current	Setting range Short-circuit releases Non-delayed	Rated operational power AC-3 50/60 Hz 400 V P kW	Rated operational current AC-3 50/60 Hz 400 V I <sub>e</sub> A	Fixed mounting with screw terminals	
					Part no.	Article no.
I <sub>cu</sub> kA	I <sub>n</sub> = I <sub>u</sub> A	I <sub>i</sub> = I <sub>n</sub> x... A				



### Short-circuit protection

Motor protection in conjunction with overload relay

- With short-circuit releases
- Without overload releases I<sub>r</sub> = I<sub>n</sub>x...
- IEC/EN 60947-2

### Normal switching capacity

1230PIC-787 Symbolphoto



50	40	8 - 14	18.5	36	Screw terminals as accessories	
	50	8 - 14	22	41		
	63	8 - 14	30	55		
	80	8 - 14	37	68		
	100	8 - 12.5	45	81		

1230PIC-804 Symbolphoto



125	8 - 14	45	99	NZMN2-S125	265739
160	8 - 14	75	134	NZMN2-S160	265740
200	8 - 12.5	110	196	NZMN2-S200	265741

1230PIC-881 Symbolphoto



250	8 - 14	132	231	NZMN3-S250	109680
320	8 - 14	160	279	NZMN3-S320	109681
400	7 - 12.5	200	349	NZMN3-S400	109682
500	6 - 10	250	437	NZMN3-S500	109683

### Strong switching capacity

1230PIC-787 Symbolphoto



70	40	8 - 14	18.5	36	Screw terminals as accessories	
	50	8 - 14	22	41		
	63	8 - 14	30	55		
	80	8 - 14	37	68		
	100	8 - 12.5	45	99		

1230PIC-804 Symbolphoto



125	8 - 14	45	99	NZMS2-S125	109979
160	8 - 14	75	134	NZMS2-S160	109980
200	8 - 12.5	110	196	NZMS2-S200	109981

# Compact circuit breakers, switch disconnectors

# 1.2

## Circuit breakers, magnetic short-circuit releases, 3 pole NZM...S

### Fixed mounting with box terminals

Part no.

Article no.

### Plug-in/withdrawable units

Part no.

Article no.

Std. pack

Order base separately

For further terminal types  
see accessories

NZMN1-S40	265731		NZMN1-S40-SVE	112768	1 Off
NZMN1-S50	265732		NZMN1-S50-SVE	112769	
NZMN1-S63	265733		NZMN1-S63-SVE	112770	
NZMN1-S80	265734		NZMN1-S80-SVE	112771	
NZMN1-S100	265735		NZMN1-S100-SVE	112772	

Terminals as accessory	_____		NZMN2-S125-SVE	113253	
	_____		NZMN2-S160-SVE	113254	
	_____		NZMN2-S200-SVE	113255	

Terminals as accessory	_____		NZMN3-S250-SVE	168489	
	_____		NZMN3-S250-AVE	113523	
	_____		NZMN3-S320-SVE	168490	
	_____		NZMN3-S320-AVE	113524	
	_____		NZMN3-S400-SVE	168491	
	_____		NZMN3-S400-AVE	113525	
	_____		NZMN3-S500-SVE	168492	
	_____		NZMN3-S500-AVE	113526	

NZMS1-S40	109943		NZMS1-S40-SVE	112790	1 Off
NZMS1-S50	109944		NZMS1-S50-SVE	112791	
NZMS1-S63	109945		NZMS1-S63-SVE	112792	
NZMS1-S80	109946		NZMS1-S80-SVE	112793	
NZMS1-S100	109947		NZMS1-S100-SVE	112794	

Terminals as accessory	_____		NZMS2-S125-SVE	113304	
	_____		NZMS2-S160-SVE	113305	
	_____		NZMS2-S200-SVE	113306	

# 1.2

## Compact circuit breakers, switch disconnectors

Circuit breakers, magnetic short-circuit releases, 3 pole  
NZM...S

Switching capacity 400/415V 50/60 Hz	Rated current = Rated uninterrupted current	Setting range Short-circuit releases Non-delayed	Rated operational power 50/60 Hz 400 V P kW	Rated operational current AC-3 50/60 Hz 400 V I <sub>e</sub> A	Fixed mounting with screw terminals	
					Part no.	Article no.
I <sub>cu</sub> kA	I <sub>n</sub> = I <sub>u</sub> A	I <sub>i</sub> = I <sub>n</sub> x... A				



### Short-circuit protection

Motor protection in conjunction with overload relay

- With short-circuit releases
- Without overload releases I<sub>r</sub> = I<sub>n</sub>x...
- IEC/EN 60947-2

### High switching capacity

1230PIC-787 Symbolphoto



100	40	8 - 14	18.5	36	Screw terminals as accessories	
	50	8 - 14	22	41		
	63	8 - 14	30	55		
	80	8 - 14	37	68		
	100	8 - 12.5	45	81		

1230PIC-804 Symbolphoto



150	40	8 - 14	22	41	NZMH2-S40	265742
	50	8 - 14	30	55	NZMH2-S50	265743
	63	8 - 14	37	68	NZMH2-S63	265744
	80	8 - 14	45	99	NZMH2-S80	265745
	100	8 - 14	45	99	NZMH2-S100	265746
	125	8 - 14	75	134	NZMH2-S125	265747
	160	8 - 12.5	110	196	NZMH2-S160	265748
200	8 - 12.5	110	196	NZMH2-S200	265749	

1230PIC-881 Symbolphoto



250	8 - 14	132	231	NZMH3-S250	109684	
	320	8 - 14	160	279	NZMH3-S320	109685
	400	7 - 12.5	200	349	NZMH3-S400	109686
	500	6 - 10	250	437	NZMH3-S500	109687
					-	

# Compact circuit breakers, switch disconnectors

# 1.2

## Circuit breakers, magnetic short-circuit releases, 3 pole NZM...S

**Fixed mounting with box terminals**  
Part no.

Article no.

**Plug-in/withdrawable units**  
Part no.

Article no.

Std. pack

Order base separately

For further terminal types  
see accessories

NZMH1-S40	284436		NZMH1-S40-SVE	112805	1 Off
NZMH1-S50	284437		NZMH1-S50-SVE	112806	
NZMH1-S63	284438		NZMH1-S63-SVE	112807	
NZMH1-S80	284439		NZMH1-S80-SVE	112808	
NZMH1-S100	284440		NZMH1-S100-SVE	112809	



Terminals as accessory	_____		NZMH2-S40-SVE	113340	
	_____		NZMH2-S50-SVE	113341	
	_____		NZMH2-S63-SVE	113342	
	_____		NZMH2-S80-SVE	113343	
	_____		NZMH2-S100-SVE	113344	
	_____		NZMH2-S125-SVE	113345	
	_____		NZMH2-S160-SVE	113346	
	_____	NZMH2-S200-SVE	113347		

Terminals as accessory	_____		NZMH3-S250-SVE	168916	
	_____		NZMH3-S250-AVE	113566	
	_____		NZMH3-S320-SVE	168917	
	_____		NZMH3-S320-AVE	113567	
	_____		NZMH3-S400-SVE	168918	
	_____		NZMH3-S400-AVE	113568	
	_____		NZMH3-S500-SVE	168919	
	_____	NZMH3-S500-AVE	113569		

# 1.3

## Compact circuit breakers, switch disconnectors

Circuit breakers IEC, electronic releases, 3 pole  
NZM...AX

Switching capacity 400/415V 50/60 Hz	Rated current = Rated uninterrupted current	Setting range		Fixed mounting with screw terminals	
		Overload releases	Short-circuit releases Non-delayed	Part no.	Article no.
$I_{cu}$ kA	$I_n = I_u$ A	$I_r = I_n \times \dots$ A	$I_s = I_n \times \dots$		
					

### System and cable protection

- IEC/EN 60947-2

#### Normal switching capacity

wa\_ren\_00418\_r Symbolphoto



50	40	20 - 40	2 - 12	NZMN2-AX40	192001
	63	25 - 63	2 - 12	NZMN2-AX63	192002
	100	40 - 100	2 - 12	NZMN2-AX100	192003
	160	64 - 160	2 - 12	NZMN2-AX160	192004
	350	100 - 250	2 - 12	NZMN2-AX250	192005

wa\_ren\_00918\_r Symbolphoto



250	100 - 250	2 - 11	NZMN3-AX250	191599
400	160 - 400	2 - 11	NZMN3-AX400	191600
630	252 - 630	2 - 8	NZMN3-AX630	191601

wa\_ren\_01418\_r Symbolphoto



630	252 - 630	2 - 12	NZMN4-AX630	191418
800	320 - 800	2 - 12	NZMN4-AX800	191419
1000	400 - 1000	2 - 12	NZMN4-AX1000	191420
1250	500 - 1250	2 - 12	NZMN4-AX1250	191421
1600	640 - 1600	2 - 12	NZMN4-AX1600	191422

#### Strong switching capacity

wa\_ren\_00418\_r Symbolphoto



70	40	20 - 40	12 - 12	NZMS2-AX40	192028
	63	25 - 63	12 - 12	NZMS2-AX63	192029
	100	40 - 100	12 - 12	NZMS2-AX100	192030
	160	64 - 160	12 - 12	NZMS2-AX160	192031
	250	100 - 250	12 - 12	NZMS2-AX250	192032

wa\_ren\_00918\_r Symbolphoto



250	100 - 250	2 - 11	NZMS3-AX250	192033
400	160 - 400	2 - 11	NZMS3-AX400	191494
630	252 - 630	2 - 8	NZMS3-AX630	191495

# Compact circuit breakers, switch disconnectors

# 1.3

Circuit breakers IEC, electronic releases, 3 pole  
NZM...AX

**Fixed mounting with box terminals**  
Part no.

Article no.

**Withdrawable units**  
Part no.

Article no.

Std. pack

Order base separately

For further terminal types  
see accessories

Terminals as accessory \_\_\_\_\_ - \_\_\_\_\_ 1 Off

\_\_\_\_\_  
\_\_\_\_\_  
\_\_\_\_\_

\_\_\_\_\_  
\_\_\_\_\_  
\_\_\_\_\_

Terminals as accessory \_\_\_\_\_  
NZMN3-AX400-BT 191586 \_\_\_\_\_  
NZMN3-AX630-BT 191587 \_\_\_\_\_



NZMN3-AX250-AVE 191574 \_\_\_\_\_  
NZMN3-AX400-AVE 191575 \_\_\_\_\_  
NZMN3-AX630-AVE 191576 \_\_\_\_\_

- \_\_\_\_\_ Withdrawable units as accessory \_\_\_\_\_  
\_\_\_\_\_  
\_\_\_\_\_  
\_\_\_\_\_  
\_\_\_\_\_

Terminals as accessory \_\_\_\_\_ - \_\_\_\_\_ 1 Off

\_\_\_\_\_  
\_\_\_\_\_  
\_\_\_\_\_

\_\_\_\_\_  
\_\_\_\_\_  
\_\_\_\_\_

Terminals as accessory \_\_\_\_\_  
\_\_\_\_\_



- \_\_\_\_\_  
NZMS3-AX400-AVE 191503 \_\_\_\_\_  
NZMS3-AX630-AVE 191504 \_\_\_\_\_

# 1.3

## Compact circuit breakers, switch disconnectors

Circuit breakers IEC, electronic releases, 3 pole  
NZM...AX

Switching capacity 400/415V 50/60 Hz	Rated current = Rated uninterrupted current	Setting range		Fixed mounting with screw terminals	
		Overload releases	Short-circuit releases Non-delayed	Part no.	Article no.
$I_{cu}$ kA	$I_n = I_u$ A	$I_r = I_n \times \dots$ A	$I_s = I_n \times \dots$		

### System and cable protection

- IEC/EN 60947-2

#### High switching capacity

wa\_ren\_00418\_r Symbolphoto



150	40	20 - 40	2 - 12	NZMH2-AX40	192007
	63	25 - 63	2 - 12	NZMH2-AX63	192008
	100	40 - 100	2 - 12	NZMH2-AX100	192009
	160	64 - 160	2 - 12	NZMH2-AX160	192010
	250	100 - 250	2 - 12	NZMH2-AX250	192011

wa\_ren\_00918\_r Symbolphoto



250	100 - 250	2 - 11	NZMH3-AX250	191346	
	400	160 - 400	2 - 11	NZMH3-AX400	191347
	630	252 - 630	2 - 8	NZMH3-AX630	191348

wa\_ren\_01418\_r Symbolphoto



85	630	252 - 630	2 - 12	NZMH4-AX630	191447
	800	320 - 800	2 - 12	NZMH4-AX800	191448
	1000	400 - 1000	2 - 12	NZMH4-AX1000	191449
	1250	500 - 1250	2 - 12	NZMH4-AX1250	191450
	1600	640 - 1600	2 - 12	NZMH4-AX1600	191451

#### Limiter switching capacity

wa\_ren\_01418\_r Symbolphoto



100	630	252 - 630	2 - 12	NZML4-AX630	191363
	800	320 - 800	2 - 12	NZML4-AX800	191364
	1000	400 - 1000	2 - 12	NZML4-AX1000	191365
	1250	500 - 1250	2 - 12	NZML4-AX1250	191366
	1600	640 - 1600	2 - 12	NZML4-AX1600	191322



# Compact circuit breakers, switch disconnectors

Circuit breakers IEC, electronic releases, 3 pole  
NZM...AX

# 1.3

**Fixed mounting with box terminals**  
Part no.

Article no.

**Withdrawable units**  
Part no.

Article no.

Std. pack

Order base separately

For further terminal types  
see accessories

Terminals as accessory	_____	-	_____	1 Off
------------------------	-------	---	-------	-------

Terminals as accessory	_____		NZMH3-AX2500-AVE	191545
	_____		NZMH3-AX400-AVE	191546
	_____		NZMH3-AX630-AVE	191547

-	_____		Withdrawable units as accessory	_____
	_____			_____
	_____			_____
	_____			_____

-	_____		Withdrawable units as accessory	1 Off
	_____			_____
	_____			_____
	_____			_____

# 1.3

## Compact circuit breakers, switch disconnectors

Circuit breakers IEC, electronic releases, 3 pole  
NZM...MX

Switching capacity 400/415V 50/60 Hz	Rated current = Setting range			Rated operational power AC-3 50/60 Hz		Rated operational current AC-3 50/60 Hz		Fixed mounting with screw terminals	
	Rated uninterrupted current	Overload releases	Short-circuit releases Non-delayed	400 V P kW	690 V P kW	400 V $I_e$ A	690 V $I_e$ A	Part no.	Article no.
$I_{cu}$ kA	$I_n = I_u$ A	$I_r = I_n \times \dots$ A	$I_s = I_n \times \dots$						

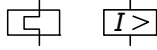

### Motor protection

- IEC/EN 60947-2

#### Normal switching capacity

wa\_ren\_00518\_r Symbolphoto



50	90	36 - 90	2 - 18	45	75	81	78	NZMN2-MX90	191631
	140	56 - 140	2 - 18	75	132	134	134	NZMN2-MX140	191632
	220	88 - 220	2 - 14	110	200	196	202	NZMN2-MX220	191633

wa\_ren\_01018\_r Symbolphoto



220	88 - 220	2 - 18	110	200	196	202	-	NZMN3-MX220	191605
	350	140 - 350	2 - 15	200	315	349	316	NZMN3-MX350	191606
	450	180 - 450	2 - 12	250	450	437	446	NZMN3-MX450	191607

wa\_ren\_01518\_r Symbolphoto



550	275 - 550	2 - 18	315	560	544	550	-	NZMN4-MX550	191428
	875	438 - 875	2 - 18	500	800	846	785	NZMN4-MX875	191429
	1400	560 - 1400	2 - 14	800	1400	1354	1374	NZMN4-MX1400	191430

#### Strong switching capacity

wa\_ren\_00518\_r Symbolphoto



70	90	36 - 90	2 - 18	45	75	81	78	NZMS2-MX90	191650
	140	56 - 140	2 - 18	75	132	134	134	NZMS2-MX140	191651
	220	88 - 220	2 - 14	110	200	196	202	NZMS2-MX220	191652

wa\_ren\_01018\_r Symbolphoto



220	88 - 220	2 - 18	110	200	196	202	-	NZMS3-MX220	191498
	350	140 - 350	2 - 15	200	315	349	316	NZMS3-MX350	191499
	450	180 - 450	2 - 12	250	450	437	446	NZMS3-MX450	191500

# Compact circuit breakers, switch disconnectors

# 1.3

## Circuit breakers IEC, electronic releases, 3 pole NZM...MX

Fixed mounting with box terminals  
Part no.

Article no.

Plug-in/withdrawable units  
Part no.

Article no.

Std. pack

Order base separately

For further terminal types  
see accessories

Terminals as accessory



NZMN2-MX90-SVE	191622	1 Off
NZMN2-MX140-SVE	191623	
NZMN2-MX220-SVE	191624	

Terminals as accessory



NZMN3-MX220-SVE	191596
NZMN3-MX220-AVE	191580
NZMN3-MX350-SVE	191597
NZMN3-MX350-AVE	191581
NZMN3-MX450-SVE	191598
NZMN3-MX450-AVE	191582

Terminals as accessory

Withdrawable units as accessory

Terminals as accessory



NZMS2-MX90-SVE	191656	1 Off
NZMS2-MX140-SVE	191657	
NZMS2-MX220-SVE	191658	

Terminals as accessory



NZMS3-MX220-SVE	191514
NZMS3-MX220-AVE	191507
NZMS3-MX350-SVE	191515
NZMS3-MX350-AVE	191508
NZMS3-MX450-SVE	191516
NZMS3-MX450-AVE	191509

# 1.3

## Compact circuit breakers, switch disconnectors

Circuit breakers IEC, electronic releases, 3 pole  
NZM...MX

Switching capacity 400/415V 50/60 Hz	Rated current = Setting range			Rated operational power		Rated operational current		Fixed mounting with screw terminals	
	Rated uninterrupted current	Overload releases	Short-circuit releases Non-delayed	AC-3 50/60 Hz	AC-3 50/60 Hz			Part no.	Article no.
$I_{cu}$ kA	$I_n = I_u$ A	$I_r = I_n \times \dots$ A	$I_s = I_n \times \dots$	400 V P kW	690 V P kW	400 V $I_e$ A	690 V $I_e$ A		

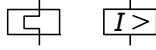

### Motor protection

- IEC/EN 60947-2

### High switching capacity

wa\_ren\_00518\_r Symbolphoto



150	90	36 - 90	2 - 18	45	75	81	78	NZMH2-MX90	191681
	140	56 - 140	2 - 18	75	132	134	134	NZMH2-MX140	191682
	220	88 - 220	2 - 14	110	200	196	202	NZMH2-MX220	191683

wa\_ren\_01018\_r Symbolphoto



220	88 - 220	2 - 18	110	200	196	202	-	NZMH3-MX220	191352
	350	140 - 350	2 - 15	200	315	349	316	NZMH3-MX350	191367
	450	180 - 450	2 - 12	250	450	437	446	NZMH3-MX450	191368

wa\_ren\_01518\_r Symbolphoto



85	550	275 - 550	2 - 18	315	560	544	550	NZMH4-MX550	191457
	875	438 - 875	2 - 18	500	800	846	785	NZMH4-MX875	191458
	1400	560 - 1400	2 - 14	800	1400	1354	1374	NZMH4-MX1400	191459

### Limiter switching capacity

wa\_ren\_01518\_r Symbolphoto



100	550	275 - 550	2 - 18	315	560	544	550	NZML4-MX550	191328
	875	438 - 875	2 - 18	500	800	846	785	NZML4-MX875	191329
	1400	560 - 1400	2 - 14	800	1400	1354	1374	NZML4-MX1400	191330

# Compact circuit breakers, switch disconnectors

# 1.3

## Circuit breakers IEC, electronic releases, 3 pole NZM...MX

**Fixed mounting with box terminals**  
Part no.

Article no.

**Plug-in/withdrawable units**  
Part no.

Article no.

Std. pack

Order base separately

For further terminal types  
see accessories

Terminals as accessory



NZMH2-MX90-SVE	191675	1 Off
NZMH2-MX140-SVE	191676	
NZMH2-MX220-SVE	191677	

Terminals as accessory



NZMH3-MX220-SVE	191372
NZMH3-MX220-AVE	191551
NZMH3-MX350-SVE	191373
NZMH3-MX350-AVE	191552
NZMH3-MX450-SVE	191374
NZMH3-MX450-AVE	191553

Terminals as accessory

Withdrawable units as accessory

\_\_\_\_\_  
\_\_\_\_\_

Terminals as accessory

Withdrawable units as accessory

\_\_\_\_\_ 1 Off  
\_\_\_\_\_

# 1.3

## Compact circuit breakers, switch disconnectors

Circuit breakers IEC, electronic releases, 3 pole  
NZM...VX

Switching capacity 400/415V 50/60 Hz	Rated current = Rated uninterrupted current	Setting range			Fixed mounting with screw terminals	
		Overload releases	Short-circuit releases delayed	Short-circuit releases Non-delayed	Part no.	Article no.
$I_{cu}$ kA	$I_n = I_u$ A	$I_r = I_n \times \dots$ A	$I_{sd} = I_n \times \dots$	$I_r = I_n \times \dots$		

### System and cable protection, selectivity and generator protection

- IEC/EN 60947-2

#### Normal switching capacity

wa\_ren\_00618\_r Symbolphoto



50	40	20 - 40	2 - 10	2 - 18	NZMN2-VX40	192013
	63	25 - 63	2 - 10	2 - 18	NZMN2-VX63	192014
	100	40 - 100	2 - 10	2 - 18	NZMN2-VX100	191628
	160	64 - 160	2 - 10	2 - 18	NZMN2-VX160	191629
	250	100 - 250	2 - 10	2 - 12	NZMN2-VX250	191630

wa\_ren\_01118\_r Symbolphoto



250	100 - 250	2 - 10	2 - 18	NZMN3-VX250	191602	
	400	160 - 400	2 - 10	2 - 12	NZMN3-VX400	191603
	630	252 - 630	1.5 - 7	2 - 8	NZMN3-VX630	191604

wa\_ren\_01618\_r Symbolphoto



630	252 - 630	2 - 10	2 - 18	NZMN4-VX630	191423	
	800	320 - 800	2 - 10	2 - 18	NZMN4-VX800	191424
	1000	400 - 1000	2 - 10	2 - 18	NZMN4-VX1000	191425
	1250	500 - 1250	2 - 10	2 - 15	NZMN4-VX1250	191426
	1600	640 - 1600	2 - 10	2 - 12	NZMN4-VX1600	191427

#### Strong switching capacity

wa\_ren\_00618\_r Symbolphoto



70	40	20 - 40	2 - 10	2 - 18	NZMS2-VX40	192035
	63	25 - 63	2 - 10	2 - 18	NZMS2-VX63	192036
	100	40 - 100	2 - 10	2 - 18	NZMS2-VX100	191647
	160	64 - 160	2 - 10	2 - 18	NZMS2-VX160	191648
	250	100 - 250	2 - 10	2 - 12	NZMS2-VX250	191649

wa\_ren\_01118\_r Symbolphoto



250	125 - 250	2 - 10	2 - 18	NZMS3-VX250	192037	
	400	160 - 400	2 - 10	2 - 12	NZMS3-VX400	191496
	630	252 - 630	1.5 - 7	2 - 8	NZMS3-VX630	191497

# Compact circuit breakers, switch disconnectors

Circuit breakers IEC, electronic releases, 3 pole  
NZM...VX

# 1.3

**Fixed mounting with box terminals**  
Part no.

Article no.

**Plug-in/withdrawable units**  
Part no.

Article no.

Std. pack

Order base separately

For further terminal types  
see accessories

Terminals as accessory \_\_\_\_\_ 1 Off

NZMN2-VX100-BT 191625  
NZMN2-VX160-BT 191626  
NZMN2-VX250-BT 191627



NZMN2-VX100-SVE 191619  
NZMN2-VX160-SVE 191620  
NZMN2-VX250-SVE 191621

Terminals as accessory \_\_\_\_\_

NZMN3-VX400-BT 191588  
Terminals as accessory  
NZMN3-VX630-BT 191589  
Terminals as accessory



NZMN3-VX250-SVE 191593  
NZMN3-VX250-AVE 191577  
NZMN3-VX400-SVE 191594  
NZMN3-VX400-AVE 191578  
NZMN3-VX630-SVE 191595  
NZMN3-VX630-AVE 191579

\_\_\_\_\_  
\_\_\_\_\_  
\_\_\_\_\_  
\_\_\_\_\_  
\_\_\_\_\_



NZMN4-VX630-AVE 191413  
NZMN4-VX800-AVE 191414  
NZMN4-VX1000-AVE 191415  
NZMN4-VX1250-AVE 191416  
NZMN4-VX1600-AVE 191417

Terminals as accessory \_\_\_\_\_

Terminals as accessory \_\_\_\_\_



NZMS2-VX100-SVE 191653  
NZMS2-VX160-SVE 191654  
NZMS2-VX250-SVE 191655



NZMS3-VX400-SVE 191512  
NZMS3-VX400-AVE 191505  
NZMS3-VX630-SVE 191513  
NZMS3-VX630-AVE 191506

# 1.3

## Compact circuit breakers, switch disconnectors

Circuit breakers IEC, electronic releases, 3 pole  
NZM...VX

Switching capacity 400/415V 50/60 Hz	Rated current = Rated uninterrupted current	Setting range			Fixed mounting with screw terminals	
		Overload releases	Short-circuit releases delayed	Short-circuit releases Non-delayed	Part no.	Article no.
$I_{cu}$ kA	$I_n = I_u$ A	$I_r = I_n \times \dots$ A	$I_{sd} = I_r \times \dots$	$I_r = I_n \times \dots$		

### System and cable protection, selectivity and generator protection

- IEC/EN 60947-2

#### High switching capacity

wa\_ren\_00618\_r Symbolphoto



150	40	20 - 40	2 - 10	2 - 18	NZMH2-VX40	192017
	63	25 - 63	2 - 10	2 - 18	NZMH2-VX63	192018
	100	40 - 100	2 - 10	2 - 18	NZMH2-VX100	191678
	160	64 - 160	2 - 10	2 - 18	NZMH2-VX160	191679
	250	100 - 250	2 - 10	2 - 12	NZMH2-VX250	191680

wa\_ren\_01118\_r Symbolphoto



250	100 - 250	2 - 10	2 - 18	NZMH3-VX250	191349	
	400	160 - 400	2 - 10	2 - 12	NZMH3-VX400	191350
	630	252 - 630	1.5 - 7	2 - 8	NZMH3-VX630	191351

wa\_ren\_01618\_r Symbolphoto



85	630	252 - 630	2 - 10	2 - 18	NZMH4-VX630	191452
	800	320 - 800	2 - 10	2 - 18	NZMH4-VX800	191453
	1000	400 - 1000	2 - 10	2 - 18	NZMH4-VX1000	191454
	1250	500 - 1250	2 - 10	2 - 15	NZMH4-VX1250	191455
	1600	640 - 1600	2 - 10	2 - 12	NZMH4-VX1600	191456

#### Limiter switching capacity

wa\_ren\_01618\_r Symbolphoto



100	630	252 - 630	2 - 10	2 - 18	NZML4-VX630	191323
	800	320 - 800	2 - 10	2 - 18	NZML4-VX800	191324
	1000	400 - 1000	2 - 10	2 - 18	NZML4-VX1000	191325
	1250	500 - 1250	2 - 10	2 - 15	NZML4-VX1250	191326
	1600	640 - 1600	2 - 10	2 - 12	NZML4-VX1600	191327



# Compact circuit breakers, switch disconnectors

# 1.3

Circuit breakers IEC, electronic releases, 3 pole  
NZM...VX

**Fixed mounting with box terminals**  
Part no.

Article no.

**Plug-in/withdrawable units**  
Part no.

Article no.

Std. pack

Order base separately

For further terminal types  
see accessories

Terminals as accessory \_\_\_\_\_ 1 Off

\_\_\_\_\_  
\_\_\_\_\_  
\_\_\_\_\_



NZMH2-VX100-SVE	191672
NZMH2-VX160-SVE	191673
NZMH2-VX250-SVE	191674

Terminals as accessory \_\_\_\_\_

- \_\_\_\_\_

NZMH3-VX400-BT 191557 \_\_\_\_\_

- \_\_\_\_\_

NZMH3-VX630-BT 191558 \_\_\_\_\_

- \_\_\_\_\_



NZMH3-VX250-SVE	191369
NZMH3-VX250-AVE	191548
NZMH3-VX400-SVE	191370
NZMH3-VX400-AVE	191549
NZMH3-VX630-SVE	191371
NZMH3-VX630-AVE	191550

- \_\_\_\_\_

\_\_\_\_\_  
\_\_\_\_\_  
\_\_\_\_\_



NZMH4-VX630-AVE	193328
NZMH4-VX800-AVE	193329
NZMH4-VX1000-AVE	193330
NZMH4-VX1250-AVE	193331
NZMH4-VX1600-AVE	193332

- \_\_\_\_\_ Withdrawable units as accessory \_\_\_\_\_ 1 Off

\_\_\_\_\_  
\_\_\_\_\_  
\_\_\_\_\_

\_\_\_\_\_  
\_\_\_\_\_  
\_\_\_\_\_

# 1.3

## Compact circuit breakers, switch disconnectors

Circuit breakers, electronic releases, 3 pole  
NZM...VX...-T

Switching capacity 400/415V 50/60 Hz	Rated current = Rated uninterrupted current	Setting range				Fixed mounting with screw terminals	
		Overload releases	Short-circuit releases delayed	Short-circuit releases Non-delayed	Earth-fault release	Part no.	Article no.
$I_{cu}$ kA	$I_n = I_u$ A	$I_r = I_n \times \dots$ A	$I_{sd} = I_r \times \dots$	$I_i = I_r \times \dots$	$I_g = I_r \times \dots$		

### System and cable protection, selectivity, generator and earth fault protection

• IEC/EN 60947-2

#### Normal switching capacity

wa\_ren\_00218\_r Symbolphoto



50	40	20 - 40	2 - 10	2 - 18	20 - 40	NZMN2-VX40-T	193287
	63	25 - 63	2 - 10	2 - 18	20 - 63	NZMN2-VX63-T	193288
	100	40 - 100	2 - 10	2 - 18	20 - 100	NZMN2-VX100-T	193289
	160	64 - 160	2 - 10	2 - 18	32 - 160	NZMN2-VX160-T	193290
	250	100 - 250	2 - 10	2 - 12	50 - 250	NZMN2-VX250-T	193291

wa\_ren\_01218\_r Symbolphoto



250	100 - 250	2 - 10	2 - 18	50 - 250	NZMN3-VX250-T	191583
400	160 - 400	2 - 10	2 - 12	80 - 400	NZMN3-VX400-T	191584
630	252 - 630	1.5 - 7	2 - 8	125 - 630	NZMN3-VX630-T	191585

wa\_ren\_01718\_r Symbolphoto



630	315 - 630	2 - 10	2 - 18	125 - 630	NZMN4-VX630-T	193310
800	400 - 800	2 - 10	2 - 18	160 - 800	NZMN4-VX800-T	193311
1000	500 - 1000	2 - 10	2 - 18	200 - 1000	NZMN4-VX1000-T	193312
1250	630 - 1250	2 - 10	2 - 15	250 - 1250	NZMN4-VX1250-T	193313
1600	800 - 1600	2 - 10	2 - 12	320 - 1600	NZMN4-VX1600-T	193314

# Compact circuit breakers, switch disconnectors

# 1.3

Circuit breakers, electronic releases, 3 pole  
 NZM...VX...-T

**Fixed mounting with box terminals**  
 Part no.

Article no.

**Withdrawable units**  
 Part no.

Article no.

Std. pack

Order base separately

For further terminal types  
 see accessories

Terminals as accessory	_____	-	_____	1 Off
	_____		_____	
	_____		_____	
	_____		_____	

Terminals as accessory	_____		NZMN3-VX250-T-AVE	191590	1 Off
	_____		NZMN3-VX400-T-AVE	191591	
			NZMN3-VX630-T-AVE	191592	

-	_____		Withdrawable units as accessory	_____	1 Off
	_____			_____	
	_____			_____	
	_____			_____	

# 1.3

## Compact circuit breakers, switch disconnectors

Circuit breakers, electronic releases, 3 pole  
NZM...VX...-T

Switching capacity 400/415V 50/60 Hz	Rated current = Rated uninterrupted current	Setting range				Fixed mounting with screw terminals	
		Overload releases	Short-circuit releases delayed	Short-circuit releases Non-delayed	Earth-fault release Alarm or trip	Part no.	Article no.
$I_{cu}$ kA	$I_n = I_u$ A	$I_r = I_n \times \dots$ A	$I_{sd} = I_p \times \dots$	$I_i = I_p \times \dots$	$I_g = I_p \times \dots$		

### System and cable protection, selectivity, generator and earth fault protection

• IEC/EN 60947-2

#### Strong switching capacity

wa\_ren\_01218\_r Symbolphoto



70	400	160 - 400	2 - 10	2 - 12	80 - 400	NZMS3-VX400-T	191501
	630	252 - 630	1.5 - 7	2 - 8	126 - 630	NZMS3-VX630-T	191502

#### High switching capacity

wa\_ren\_00218\_r Symbolphoto



150	40	20 - 40	2 - 10	2 - 18	20 - 40	NZMH2-VX40-T	193293
	63	25 - 63	2 - 10	2 - 18	20 - 63	NZMH2-VX63-T	193294
	100	40 - 100	2 - 10	2 - 18	20 - 100	NZMH2-VX100-T	193295
	160	64 - 160	2 - 10	2 - 18	32 - 160	NZMH2-VX160-T	193296
	250	100 - 250	2 - 10	2 - 12	50 - 250	NZMH2-VX250-T	193297

wa\_ren\_01218\_r Symbolphoto



250	100 - 250	2 - 10	2 - 18	50 - 250	NZMH3-VX250-T	191554	
	400	160 - 400	2 - 10	2 - 12	80 - 400	NZMH3-VX400-T	191555
	630	252 - 630	1.5 - 7	2 - 8	126 - 630	NZMH3-VX630-T	191556

wa\_ren\_01718\_r Symbolphoto



85	630	252 - 630	2 - 10	2 - 18	125 - 630	NZMH4-VX630-T	193315
	800	320 - 800	2 - 10	2 - 18	160 - 800	NZMH4-VX800-T	193316
	1000	400 - 1000	2 - 10	2 - 18	200 - 1000	NZMH4-VX1000-T	193317
	1250	500 - 1250	2 - 10	2 - 15	250 - 1250	NZMH4-VX1250-T	193318
	1600	640 - 1600	2 - 10	2 - 12	320 - 1600	NZMH4-VX1600-T	193319

# Compact circuit breakers, switch disconnectors

# 1.3

## Circuit breakers, electronic releases, 3 pole NZM...VX...-T

**Fixed mounting with box terminals**  
Part no.

Article no.

**Withdrawable units**  
Part no.

Article no.

Std. pack

Order base separately

For further terminal types  
see accessories

Terminals as accessory	_____	NZMS3-VX400-T-AVE	191510	1 Off
		NZMS3-VX630-T-AVE	191511	

Terminals as accessory	_____	_____	_____	1 Off
	_____	_____	_____	
	_____	_____	_____	
	_____	_____	_____	



Terminals as accessory	_____		NZMH3-VX250-T-AVE	191559	1 Off
	_____		NZMH3-VX400-T-AVE	191560	
			NZMH3-VX630-T-AVE	191561	

-	_____	Withdrawable units as accessory	_____	1 Off
	_____		_____	
	_____		_____	
	_____		_____	

# 1.4

## Compact circuit breakers, switch disconnectors

Circuit breakers IEC, electronic releases with energy meter function, 3 pole NZM...PMX

Switching capacity 400/415V 50/60 Hz	Rated current = Rated uninterrupted current	Setting range		Fixed mounting with screw terminals	
		Overload releases	Short-circuit releases Non-delayed	Part no.	Article no.
$I_{cu}$ kA	$I_n = I_u$ A	$I_r = I_n \times \dots$ A	$I_s = I_n \times \dots$		
					

### Motor protection

- Energy metering class I up to IEC61557-12
- With phase-failure sensitivity
- IEC/EN 60947-2

### Normal switching capacity

wa\_ren\_00318\_r Symbolphoto



50	40	20 - 40	2 - 18	NZMN2-PMX40	192104
	63	25 - 63	2 - 18	NZMN2-PMX63	192105
	100	40 - 100	2 - 18	NZMN2-PMX100	192106
	160	64 - 160	2 - 18	NZMN2-PMX160	192107
	220	88 - 220	2 - 14	NZMN2-PMX220	192108

wa\_ren\_00818\_r Symbolphoto



250	100 - 250	2 - 18	NZMN3-PMX250	192322
	-	-	-	-
	350	140 - 350	2 - 15	NZMN3-PMX350
450	180 - 450	2 - 12	NZMN3-PMX450	192324
	-	-	-	-

wa\_ren\_01818\_r Symbolphoto



550	220 - 550	2 - 18	NZMN4-PMX550	189681	
	875	350 - 875	2 - 18	NZMN4-PMX875	189682
	1400	560 - 1400	2 - 14	NZMN4-PMX1400	189683

# Compact circuit breakers, switch disconnectors

# 1.4

Circuit breakers IEC, electronic releases with energy meter function, 3 pole  
NZM...PMX

**Fixed mounting with box terminals**  
Part no.

Article no.

**Plug-in/withdrawable units**  
Part no.

Article no.

Std. pack

Order base separately

For further terminal types  
see accessories

Terminals as accessory

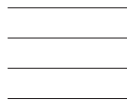

NZMN2-PMX40-SVE	192116	1 Off
NZMN2-PMX63-SVE	192117	
NZMN2-PMX100-SVE	192118	
NZMN2-PMX160-SVE	192119	
NZMN2-PMX220-SVE	192120	

Terminals as accessory

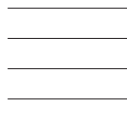

NZMN3-PMX250-SVE	192328	
NZMN3-PMX250-AVE	192334	
NZMN3-PMX350-SVE	192329	
NZMN3-PMX350-AVE	192335	
NZMN3-PMX450-SVE	192330	
NZMN3-PMX450-AVE	192336	

-





NZMN4-PMX550-AVE	189687	
NZMN4-PMX875-AVE	189688	
NZMN4-PMX1400-AVE	189689	

# 1.4

## Compact circuit breakers, switch disconnectors

Circuit breakers IEC, electronic releases with energy meter function, 3 pole NZM...PMX

Switching capacity 400/415V 50/60 Hz	Rated current = Rated uninterrupted current	Setting range		Fixed mounting with screw terminals	
		Overload releases	Short-circuit releases Non-delayed	Part no.	Article no.
$I_{cu}$ kA	$I_n = I_u$ A	$I_r = I_n \times \dots$ A	$I_s = I_n \times \dots$		
					

### Motor protection

- Energy metering class I up to IEC61557-12
- With phase-failure sensitivity
- IEC/EN 60947-2

### High switching capacity

wa\_ren\_00318\_r Symbolphoto



150	40	20 - 40	2 - 18	NZMH2-PMX40	192110
	63	25 - 63	2 - 18	NZMH2-PMX63	192111
	100	40 - 100	2 - 18	NZMH2-PMX100	192112
	160	64 - 160	2 - 18	NZMH2-PMX160	192113
	220	88 - 220	2 - 14	NZMH2-PMX220	192114

wa\_ren\_00818\_r Symbolphoto



250	100 - 250	2 - 18	NZMH3-PMX250	192325	
	350	140 - 350	2 - 15	NZMH3-PMX350	192326
	450	180 - 450	2 - 12	NZMH3-PMX450	192327

wa\_ren\_01818\_r Symbolphoto



85	550	220 - 550	2 - 18	NZMH4-PMX550	189684
	875	350 - 875	2 - 18	NZMH4-PMX875	189685
	1400	560 - 1400	2 - 14	NZMH4-PMX1400	189686

### Limiter switching capacity

wa\_ren\_01818\_r Symbolphoto



100	550	220 - 550	2 - 18	NZML4-PMX550	189706
	875	350 - 875	2 - 18	NZML4-PMX875	189707
	1400	560 - 1400	2 - 14	NZML4-PMX1400	189708



# Compact circuit breakers, switch disconnectors

# 1.4

Circuit breakers IEC, electronic releases with energy meter function, 3 pole  
NzM...PMX

Fixed mounting with box terminals  
Part no.

Article no.

Plug-in/withdrawable units  
Part no.

Article no.

Std. pack

Order base separately

For further terminal types  
see accessories

Terminals as accessory

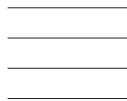

NZMH2-PMX40-SVE	192122	1 Off
NZMH2-PMX63-SVE	192123	
NZMH2-PMX100-SVE	192124	
NZMH2-PMX160-SVE	192125	
NZMH2-PMX220-SVE	192126	

Terminals as accessory

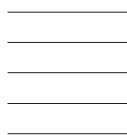

NZMH3-PMX250-SVE	192331	
NZMH3-PMX250-AVE	192337	
NZMH3-PMX350-SVE	192332	
NZMH3-PMX350-AVE	192338	
NZMH3-PMX450-SVE	192333	
NZMH3-PMX450-AVE	192339	

-



NZMH4-PMX550-AVE	189690	
NZMH4-PMX875-AVE	189691	
NZMH4-PMX1400-AVE	189692	

1 Off

# 1.4

## Compact circuit breakers, switch disconnectors

Circuit breakers IEC, electronic releases with energy meter function, 3 pole NZM...PX

Switching capacity 400/415V 50/60 Hz	Rated current = Rated uninterrupted current	Setting range			Fixed mounting with screw terminals	
		Overload releases	Short-circuit releases delayed	Short-circuit releases Non-delayed	Part no.	Article no.
$I_{cu}$ kA	$I_n = I_u$ A	$I_r = I_n \times \dots$ A	$I_{sd} = I_r \times \dots$	$I_r = I_n \times \dots$		

### System and cable protection, selectivity and generator protection

- Energy metering class I up to IEC61557-12
- IEC/EN 60947-2

### Normal switching capacity

wa\_ren\_00318\_r Symbolphoto



50	40	20 - 40	2 - 10	2 - 18	NZMN2-PX40	192237
	63	25 - 63	2 - 10	2 - 18	NZMN2-PX63	192238
	100	40 - 100	2 - 10	2 - 18	NZMN2-PX100	192239
	160	64 - 160	2 - 10	2 - 18	NZMN2-PX160	192240
	250	100 - 250	2 - 10	2 - 12	NZMN2-PX250	192241

wa\_ren\_00818\_r Symbolphoto



250	100 - 250	2 - 10	2 - 18	NZMN3-PX250	192354	
	400	160 - 400	2 - 10	2 - 12	NZMN3-PX400	192355
	630	252 - 630	1.5 - 7	2 - 8	NZMN3-PX630	192356

wa\_ren\_01818\_r Symbolphoto



630	252 - 630	2 - 10	2 - 18	NZMN4-PX630	189601	
	800	320 - 800	2 - 10	2 - 18	NZMN4-PX800	189602
	1000	400 - 1000	2 - 10	2 - 18	NZMN4-PX1000	189603
	1250	500 - 1250	2 - 10	2 - 15	NZMN4-PX1250	189604
	1600	640 - 1600	2 - 10	2 - 12	NZMN4-PX1600	189605

# Compact circuit breakers, switch disconnectors

# 1.4

Circuit breakers IEC, electronic releases with energy meter function, 3 pole  
NZM...PX

### Fixed mounting with box terminals

Part no. Article no.

### Plug-in/withdrawable units

Part no. Article no. Std. pack

Order base separately

For further terminal types  
see accessories

NZMN2-PX40-BT	192046		NZMN2-PX40-SVE	192162	1 Off
NZMN2-PX63-BT	192047		NZMN2-PX63-SVE	192163	
NZMN2-PX100-BT	192048		NZMN2-PX100-SVE	192164	
NZMN2-PX160-BT	192049		NZMN2-PX160-SVE	192165	
NZMN2-PX250-BT	192050		NZMN2-PX250-SVE	192166	

NZMN3-PX250-BT	192363		NZMN3-PX250-SVE	192264	
-			NZMN3-PX250-AVE	192348	
NZMN3-PX400-BT	192364		NZMN3-PX400-SVE	192340	
-			NZMN3-PX400-AVE	192349	
NZMN3-PX630-BT	192365		NZMN3-PX630-SVE	192341	

-			NZMN4-PX630-AVE	189621	
			NZMN4-PX800-AVE	189622	
			NZMN4-PX1000-AVE	189623	
			NZMN4-PX1250-AVE	189624	
			NZMN4-PX1600-AVE	189625	

# 1.4

## Compact circuit breakers, switch disconnectors

Circuit breakers IEC, electronic releases with energy meter function, 3 pole NZM...PX

Switching capacity 400/415V 50/60 Hz	Rated current = Rated uninterrupted current	Setting range			Fixed mounting with screw terminals	
		Overload releases	Short-circuit releases delayed	Short-circuit releases Non-delayed	Part no.	Article no.
$I_{cu}$ kA	$I_n = I_u$ A	$I_r = I_n \times \dots$ A	$I_{sf} = I_r \times \dots$	$I_r = I_n \times \dots$		

### System and cable protection, selectivity and generator protection

- Energy metering class I up to IEC61557-12
- IEC/EN 60947-2

#### Strong switching capacity

wa\_ren\_00318\_r Symbolphoto



70	40	20 - 40	2 - 10	2 - 18	NZMS2-PX40	192244
	63	25 - 63	2 - 10	2 - 18	NZMS2-PX63	192245
	100	40 - 100	2 - 10	2 - 18	NZMS2-PX100	192246
	160	64 - 160	2 - 10	2 - 18	NZMS2-PX160	192247
	250	100 - 250	2 - 10	2 - 12	NZMS2-PX250	192248

wa\_ren\_00818\_r Symbolphoto



250	100 - 250	2 - 10	2 - 18	NZMS3-PX250	192357	
	400	160 - 400	2 - 10	2 - 12	NZMS3-PX400	192358
	630	252 - 630	1.5 - 7	2 - 8	NZMS3-PX630	192359

#### High switching capacity

wa\_ren\_00318\_r Symbolphoto



150	40	20 - 40	2 - 10	2 - 18	NZMH2-PX40	192039
	63	25 - 63	2 - 10	2 - 18	NZMH2-PX63	192040
	100	40 - 100	2 - 10	2 - 18	NZMH2-PX100	192041
	160	64 - 160	2 - 10	2 - 18	NZMH2-PX160	192042
	250	100 - 250	2 - 10	2 - 12	NZMH2-PX250	192043

wa\_ren\_00818\_r Symbolphoto



250	100 - 250	2 - 10	2 - 18	NZMH3-PX250	192360	
	400	160 - 400	2 - 10	2 - 12	NZMH3-PX400	192361
	630	252 - 630	1.5 - 7	2 - 8	NZMH3-PX630	192362

wa\_ren\_01818\_r Symbolphoto



85	630	315 - 630	2 - 10	2 - 18	NZMH4-PX630	189606
	800	400 - 800	2 - 10	2 - 18	NZMH4-PX800	189607
	1000	500 - 1000	2 - 10	2 - 18	NZMH4-PX1000	189608
	1250	630 - 1250	2 - 10	2 - 15	NZMH4-PX1250	189609
	1600	800 - 1600	2 - 10	2 - 12	NZMH4-PX1600	189610

# Compact circuit breakers, switch disconnectors

# 1.4

Circuit breakers IEC, electronic releases with energy meter function, 3 pole  
NZM...PX

### Fixed mounting with box terminals

Part no. Article no.

### Plug-in/withdrawable units

Part no. Article no. Std. pack

Order base separately

For further terminal types  
see accessories

NZMS2-PX40-BT	192127
NZMS2-PX63-BT	192128
NZMS2-PX100-BT	192129
NZMS2-PX160-BT	192130
NZMS2-PX250-BT	192131



NZMS2-PX40-SVE	192169	1 Off
NZMS2-PX63-SVE	192170	
NZMS2-PX100-SVE	192171	
NZMS2-PX160-SVE	192172	
NZMS2-PX250-SVE	192173	

NZMS3-PX250-BT	192366
-	
NZMS3-PX400-BT	192367
-	
NZMS3-PX630-BT	192251
-	



NZMS3-PX250-SVE	192342
NZMS3-PX250-AVE	192351
NZMS3-PX400-SVE	192343
NZMS3-PX400-AVE	192352
NZMS3-PX630-SVE	192344
NZMS3-PX630-AVE	192353

NZMH2-PX40-BT	192134
NZMH2-PX63-BT	192135
NZMH2-PX100-BT	192136
NZMH2-PX160-BT	192137
NZMH2-PX250-BT	192138



NZMH2-PX40-SVE	192176	1 Off
NZMH2-PX63-SVE	192177	
NZMH2-PX100-SVE	192178	
NZMH2-PX160-SVE	192179	
NZMH2-PX250-SVE	192180	

NZMH3-PX250-BT	192252
-	
NZMH3-PX400-BT	192253
-	
NZMH3-PX630-BT	192254
-	



NZMH3-PX250-SVE	192345
NZMH3-PX250-AVE	192265
NZMH3-PX400-SVE	192346
NZMH3-PX400-AVE	192266
NZMH3-PX630-SVE	192347
NZMH3-PX630-AVE	192267

-	
-	
-	
-	



NZMH4-PX630-AVE	189626
NZMH4-PX800-AVE	189627
NZMH4-PX1000-AVE	189628
NZMH4-PX1250-AVE	189629
NZMH4-PX1600-AVE	189630

# 1.4

## Compact circuit breakers, switch disconnectors

Circuit breakers IEC, electronic releases with energy meter function, 3 pole NZM...PX

Switching capacity 400/415V 50/60 Hz	Rated current = Rated uninterrupted current	Setting range			Fixed mounting with screw terminals		Std. pack
		Overload releases	Short-circuit releases delayed	Short-circuit releases Non-delayed	Part no.	Article no.	
$I_{cu}$ kA	$I_n = I_u$ A	$I_r = I_n \times \dots$ A	$I_{sd} = I_n \times \dots$	$I_i = I_n \times \dots$			

### System and cable protection, selectivity and generator protection

- Energy metering class I up to IEC61557-12
- IEC/EN 60947-2

### Limiting switching capacity

100	630	252 - 630	2 - 10	2 - 18	NZML4-PX630	189697	1 Off
	800	320 - 800	2 - 10	2 - 18	NZML4-PX800	189698	
	1000	400 - 1000	2 - 10	2 - 18	NZML4-PX1000	189699	
	1250	500 - 1250	2 - 10	2 - 15	NZML4-PX1250	189700	
	1600	640 - 1600	2 - 10	2 - 12	NZML4-PX1600	189701	

wa\_ren\_01818\_r Symbolphoto





# 1.4

## Compact circuit breakers, switch disconnectors

Circuit breakers IEC, electronic releases with energy meter function, 3 pole  
NZM...PX...-TZ, ...-TAZ

Switching capacity 400/415V 50/60 Hz	Rated current = Rated uninterrupted current	Setting range				Fixed mounting with screw terminals	
		Overload releases	Short-circuit releases delayed	Short-circuit releases Non-delayed	Earth-fault release	Part no.	Article no.
$I_{cu}$ kA	$I_n = I_u$ A	$I_r = I_n \times \dots$ A	$I_{sd} = I_r \times \dots$	$I_l = I_r \times \dots$	$I_G = I_n \times \dots$		

### System and cable protection, selectivity, generator and earth fault protection

- Energy metering class I up to IEC61557-12
- IEC/EN 60947-2
- NZM3, NZM4: with maintenance mode ARMs and zone-selective interlocking ZSI
- NZM2: with zone-selective interlocking ZSI

#### Normal switching capacity

wa\_ren\_00318\_r Symbolphoto



50	40	20 - 40	2 - 10	2 - 18	20 - 40	NZMN2-PX40-TZ	192141
	63	25 - 63	2 - 10	2 - 18	20 - 63	NZMN2-PX63-TZ	192142
	100	40 - 100	2 - 10	2 - 18	20 - 100	NZMN2-PX100-TZ	192143
	160	64 - 160	2 - 10	2 - 18	32 - 160	NZMN2-PX160-TZ	192144
	250	100 - 250	2 - 10	2 - 12	50 - 250	NZMN2-PX250-TZ	192145

wa\_ren\_00818\_r Symbolphoto



250	100 - 250	2 - 10	2 - 18	50 - 250	NZMN3-PX250-TAZ	192255
400	160 - 400	2 - 10	2 - 12	80 - 400	NZMN3-PX400-TAZ	192256
630	252 - 630	1.5 - 7	2 - 8	126 - 630	NZMN3-PX630-TAZ	192257

wa\_ren\_01818\_r Symbolphoto



630	252 - 630	2 - 10	2 - 18	126 - 630	NZMN4-PX630-TAZ	189611
800	320 - 800	2 - 10	2 - 18	160 - 800	NZMN4-PX800-TAZ	189612
1000	400 - 1000	2 - 10	2 - 18	200 - 1000	NZMN4-PX1000-TAZ	189613
1250	500 - 1250	2 - 10	2 - 15	250 - 1250	NZMN4-PX1250-TAZ	189614
1600	640 - 1600	2 - 10	2 - 12	320 - 1600	NZMN4-PX1600-TAZ	189615

#### Strong switching capacity

wa\_ren\_00318\_r Symbolphoto



70	40	20 - 40	2 - 10	2 - 18	20 - 40	NZMS2-PX40-TZ	192148
	63	25 - 63	2 - 10	2 - 18	20 - 63	NZMS2-PX63-TZ	192149
	100	40 - 100	2 - 10	2 - 18	20 - 100	NZMS2-PX100-TZ	192150
	160	64 - 160	2 - 10	2 - 18	32 - 160	NZMS2-PX160-TZ	192151
	250	100 - 250	2 - 10	2 - 12	50 - 250	NZMS2-PX250-TZ	192152

wa\_ren\_00818\_r Symbolphoto



250	100 - 250	2 - 10	2 - 18	50 - 250	NZMS3-PX250-TAZ	192258
400	160 - 400	2 - 10	2 - 12	80 - 400	NZMS3-PX400-TAZ	192259
630	252 - 630	1.5 - 7	2 - 8	126 - 630	NZMS3-PX630-TAZ	192260



# Compact circuit breakers, switch disconnectors

# 1.4

Circuit breakers IEC, electronic releases with energy meter function, 3 pole  
 NZM...PX...-TZ, ...-TAZ

Fixed mounting with box terminals  
 Part no.

Article no.

Plug-in/withdrawable units  
 Part no.

Article no.

Std. pack

Order base separately

For further terminal types  
 see accessories

Terminals as accessory

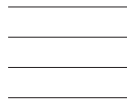

NZMN2-PX40-TZ-SVE	192183	1 Off
NZMN2-PX63-TZ-SVE	192184	
NZMN2-PX100-TZ-SVE	192185	
NZMN2-PX160-TZ-SVE	192186	
NZMN2-PX250-TZ-SVE	192187	

Terminals as accessory



NZMN3-PX250-TAZ-AVE	192268
NZMN3-PX400-TAZ-AVE	192269
NZMN3-PX630-TAZ-AVE	192270

-

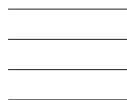

NZMN4-PX630-TAZ-AVE	189631
NZMN4-PX800-TAZ-AVE	189632
NZMN4-PX1000-TAZ-AVE	189633
NZMN4-PX1250-TAZ-AVE	189634
NZMN4-PX1600-TAZ-AVE	189635

Terminals as accessory

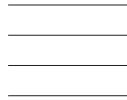

NZMS2-PX40-TZ-SVE	192190	1 Off
NZMS2-PX63-TZ-SVE	192191	
NZMS2-PX100-TZ-SVE	192192	
NZMS2-PX160-TZ-SVE	192193	
NZMS2-PX250-TZ-SVE	192194	

Terminals as accessory



NZMS3-PX250-TAZ-AVE	192271
NZMS3-PX400-TAZ-AVE	192272
NZMS3-PX630-TAZ-AVE	192273

# 1.4

## Compact circuit breakers, switch disconnectors

Circuit breakers IEC, electronic releases with energy meter function, 3 pole  
 NZM...PX...-TZ, ...-TAZ

Switching capacity 400/415V 50/60 Hz	Rated current = Rated uninterrupted current	Setting range				Fixed mounting with screw terminals	
		Overload releases	Short-circuit releases delayed	Short-circuit releases Non-delayed	Earth-fault release	Part no.	Article no.
$I_{cu}$ kA	$I_n = I_u$ A	$I_r = I_n \times \dots$ A	$I_{sd} = I_r \times \dots$	$I_l = I_n \times \dots$	$I_G = I_n \times \dots$		

### System and cable protection, selectivity, generator and earth fault protection

- Energy metering class I up to IEC61557-12
- IEC/EN 60947-2
- NZM3, NZM4: with maintenance mode ARMs and zone-selective interlocking ZSI
- NZM2: with zone-selective interlocking ZSI

#### High switching capacity

sg04718\_r Symbolphoto



150	40	20 - 40	2 - 10	2 - 18	20 - 40	NZMH2-PX40-TZ	192155
	63	25 - 63	2 - 10	2 - 18	20 - 63	NZMH2-PX63-TZ	192156
	100	40 - 100	2 - 10	2 - 18	20 - 100	NZMH2-PX100-TZ	192157
	160	64 - 160	2 - 10	2 - 18	32 - 160	NZMH2-PX160-TZ	192158
	250	100 - 250	2 - 10	2 - 12	50 - 250	NZMH2-PX250-TZ	192159

wa\_ren\_00818\_r Symbolphoto



250	100 - 250	2 - 10	2 - 18	50 - 250	NZMH3-PX250-TAZ	192261
400	160 - 400	2 - 10	2 - 12	80 - 400	NZMH3-PX400-TAZ	192262
630	252 - 630	1.5 - 7	2 - 8	126 - 630	NZMH3-PX630-TAZ	192263

wa\_ren\_01818\_r Symbolphoto



85	630	252 - 630	2 - 10	2 - 18	126 - 630	NZMH4-PX630-TAZ	189616
	800	320 - 800	2 - 10	2 - 18	160 - 800	NZMH4-PX800-TAZ	189617
	1000	400 - 1000	2 - 10	2 - 18	200 - 1000	NZMH4-PX1000-TAZ	189618
	1250	500 - 1250	2 - 10	2 - 15	250 - 1250	NZMH4-PX1250-TAZ	189619
	1600	640 - 1600	2 - 10	2 - 12	320 - 1600	NZMH4-PX1600-TAZ	189620

# Compact circuit breakers, switch disconnectors

# 1.4

Circuit breakers IEC, electronic releases with energy meter function, 3 pole  
 NZM...PX...-TZ, ...-TAZ

Fixed mounting with box terminals  
 Part no.

Article no.

Withdrawable units  
 Part no.

Article no.

Std. pack

Order base separately

For further terminal types  
 see accessories

Terminals as accessory

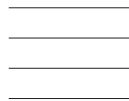

NZMH2-PX40-TZ-SVE	192197	1 Off
NZMH2-PX63-TZ-SVE	192198	
NZMH2-PX100-TZ-SVE	192199	
NZMH2-PX160-TZ-SVE	192200	
NZMH2-PX250-TZ-SVE	192201	

Terminals as accessory



NZMH3-PX250-TAZ-AVE	192274
NZMH3-PX400-TAZ-AVE	192275
NZMH3-PX630-TAZ-AVE	192276





NZMH4-PX630-TAZ-AVE	189636
NZMH4-PX800-TAZ-AVE	189637
NZMH4-PX1000-TAZ-AVE	189638
NZMH4-PX1250-TAZ-AVE	189639
NZMH4-PX1600-TAZ-AVE	189640

# 1.5

## Compact circuit breakers, switch disconnectors

Circuit breakers IEC, thermomagnetic releases, 4 pole  
NZM...-4-A

Switching capacity 400/415V 50/60 Hz	Rated current = Rated uninterrupted current		Setting range		Fixed mounting with screw terminals	
	Phase conductor $I_n = I_u$	Neutral conductor $I_n = I_r \times \dots \times$ % of phase conductor	Overload releases $I_r = I_r \times \dots$	Short-circuit releases Non-delayed $I_s = I_s \times \dots$	Part no.	Article no.
$I_{cu}$	A	%	A			
kA						

### System and cable protection

- IEC/EN 60947-2

#### Basic switching capacity

1230PIC-784 Symbolphoto



25	20	100	15 - 20	350 A fixed	Screw terminals as accessories
	25	100	20 - 25	350 A fixed	
	32	100	25 - 32	350 A fixed	
	40	100	32 - 40	8 - 10	
	50	100	40 - 50	6 - 10	
	63	100	50 - 63	6 - 10	
	80	100	63 - 80	6 - 10	
	100	100	80 - 100	6 - 10	
	125	100	100 - 125	6 - 10	
	160	100	125 - 160	1280 A fixed	

1230PIC-801 Symbolphoto



125	100	100 - 125	6 - 10	NZMB2-4-A125	265847
	60	125 - 160	6 - 10	NZMB2-4-A160/100	265849
160	100	125 - 160	6 - 10	NZMB2-4-A160/100	265850
	60	160 - 200	6 - 10	NZMB2-4-A200/125	265852
200	100	160 - 200	6 - 10	NZMB2-4-A200	265853
	60	160 - 200	6 - 10	NZMB2-4-A200/125	265855
250	100	200 - 250	6 - 10	NZMB2-4-A250	265856
	60	200 - 250	6 - 10	NZMB2-4-A250/160	107582
300	100	240 - 300	5 - 8.3	NZMB2-4-A300	107583
	60	240 - 300	5 - 8.3	NZMB2-4-A300/200	

# Compact circuit breakers, switch disconnectors

# 1.5

Circuit breakers IEC, thermomagnetic releases, 4 pole  
NZM...-4-A

Fixed mounting with box terminals  
Part no.

Article no.

Plug-in units  
Part no.

Article no.

Std. pack

Order base separately

For further terminal types  
see accessories

NZMB1-4-A20	281237	-	1 Off
NZMB1-4-A25	281239		
NZMB1-4-A32	281241		
NZMB1-4-A40	265799		
NZMB1-4-A50	265801		
NZMB1-4-A63	265803		
NZMB1-4-A80	265805		
NZMB1-4-A100	265807		
NZMB1-4-A125	265809		
NZMB1-4-A160	281243		

Terminals as accessory





NZMB2-4-A125-SVE	113207
NZMB2-4-A160-SVE	113209
NZMB2-4-A160/100-SVE	113210
NZMB2-4-A200-SVE	113212
NZMB2-4-A200/125-SVE	113213
NZMB2-4-A250-SVE	113215
NZMB2-4-A250/160-SVE	113216
-	
-	

# 1.5

## Compact circuit breakers, switch disconnectors

Circuit breakers IEC, thermomagnetic releases, 4 pole  
NZM...-4-A

Switching capacity 400/415V 50/60 Hz	Rated current = Rated uninterrupted current		Setting range		Fixed mounting with screw terminals	
	Phase conductor $I_n = I_u$	Neutral conductor $I_n = I_p \times \dots \times$ % of phase conductor	Overload releases	Short-circuit releases	Part no.	Article no.
			Non-delayed			
$I_{cu}$	A	%	$I_r = I_p \times \dots$	$I_r = I_p \times \dots$		
kA			A			
						

### System and cable protection

- IEC/EN 60947-2

#### Comfort switching capacity

1230PIC-784 Symbolphoto



36	20	100	15 - 20	350 A fixed	Screw terminals as accessories	
	25	100	20 - 25	350 A fixed		
	32	100	25 - 32	350 A fixed		
	40	100	32 - 40	8 - 10		
	50	100	40 - 50	6 - 10		
	63	100	50 - 63	6 - 10		
	80	100	63 - 80	6 - 10		
	100	100	80 - 100	6 - 10		
	125	100	100 - 125	6 - 10		
160	100	125 - 160	1280 A fixed			

1230PIC-801 Symbolphoto



125	100	100 - 125	6 - 10	NZMC2-4-A125	271430
160	100	125 - 160	6 - 10	NZMC2-4-A160	271432
	60	125 - 160	6 - 10	NZMC2-4-A160/100	271433
200	100	160 - 200	6 - 10	NZMC2-4-A200	271435
	60	160 - 200	6 - 10	NZMC2-4-A200/125	271436
250	100	200 - 250	6 - 10	NZMC2-4-A250	271438
	60	200 - 250	6 - 10	NZMC2-4-A250/160	271439
300	100	240 - 300	5 - 8.3	NZMC2-4-A300	107584
	60	240 - 300	5 - 8.3	NZMC2-4-A300/200	107585

1230PIC-702 Symbolphoto



320	100	250 - 320	6 - 10	-	
	60	250 - 320	6 - 10	-	
	100	250 - 320	6 - 10	NZMC3-4-A320	109688
	60	250 - 320	6 - 10	NZMC3-4-A320/200	109689
400	100	320 - 400	6 - 10	-	
	60	320 - 400	6 - 10	-	
	100	320 - 400	6 - 10	NZMC3-4-A400	109690
500	60	320 - 400	6 - 10	NZMC3-4-A400/250	109691
	100	400 - 500	6 - 10	-	
	60	400 - 500	6 - 10	-	
	100	400 - 500	6 - 10	NZMC3-4-A500	109692
	60	400 - 500	6 - 10	NZMC3-4-A500/320	109693

# Compact circuit breakers, switch disconnectors

# 1.5

Circuit breakers IEC, thermomagnetic releases, 4 pole  
NZM...-4-A

Fixed mounting with box terminals  
Part no.

Article no.

Plug-in/withdrawable units  
Part no.

Article no.

Std. pack

Order base separately

For further terminal types  
see accessories

NZMC1-4-A20	283300	-	1 Off
NZMC1-4-A25	283302	-	
NZMC1-4-A32	283304	-	
NZMC1-4-A40	271408	-	
NZMC1-4-A50	271410	-	
NZMC1-4-A63	271412	-	
NZMC1-4-A80	271414	-	
NZMC1-4-A100	271416	-	
NZMC1-4-A125	271418	-	
NZMC1-4-A160	283306	-	

Terminals as accessory

_____
_____
_____
_____
_____
_____
_____
_____
_____
_____



NZMC2-4-A125-SVE	113231
NZMC2-4-A160-SVE	113233
NZMC2-4-A160/100-SVE	113234
NZMC2-4-A200-SVE	113236
NZMC2-4-A200/125-SVE	113237
NZMC2-4-A250-SVE	113239
NZMC2-4-A250/160-SVE	113240
-	
-	

Terminals as accessory

_____
_____
_____
_____
_____
_____
_____
_____
_____
_____



NZMC3-4-A320-SVE	168464
NZMC3-4-A320/200-SVE	168465
NZMC3-4-A320-AVE	113516
NZMC3-4-A320/200-AVE	113517
NZMC3-4-A400-SVE	168466
NZMC3-4-A400/250-SVE	168467
NZMC3-4-A400-AVE	113518
NZMC3-4-A400/250-AVE	113519
NZMC3-4-A500-SVE	168468
NZMC3-4-A500/320-SVE	168469
NZMC3-4-A500-AVE	113520
NZMC3-4-A500/320-AVE	113521

# 1.5

## Compact circuit breakers, switch disconnectors

Circuit breakers IEC, thermomagnetic releases, 4 pole  
NZM...-4-A

Switching capacity 400/415V 50/60 Hz	Rated current = Rated uninterrupted current		Setting range		Fixed mounting with screw terminals	
	Phase conductor $I_n = I_u$	Neutral conductor $I_n = I_n \times \dots \times$ % of phase conductor	Overload releases	Short-circuit releases	Part no.	Article no.
			Non-delayed			
$I_{cu}$	$I_n = I_u$	$I_n = I_n \times \dots \times$ % of phase conductor	$I_r = I_r \times \dots$	$I_r = I_r \times \dots$		
kA	A	%	A			



### System and cable protection

- IEC/EN 60947-2

#### Normal switching capacity

1230PIC-784 Symbolphoto



50	20	100	15 - 20	350 A fixed	Screw terminals as accessories	
	25	100	20 - 25	350 A fixed		
	32	100	25 - 32	350 A fixed		
	40	100	32 - 40	8 - 10		
	50	100	40 - 50	6 - 10		
	63	100	50 - 63	6 - 10		
	80	100	63 - 80	6 - 10		
	100	100	80 - 100	6 - 10		
	125	100	100 - 125	6 - 10		
	160	100	125 - 160	1280 A fixed		

1230PIC-801 Symbolphoto



125	100	100 - 125	6 - 10	NZMN2-4-A125	265858	
	160	100	125 - 160	6 - 10	NZMN2-4-A160	265860
	60	125 - 160	6 - 10	NZMN2-4-A160/100	265861	
		160 - 200	6 - 10	NZMN2-4-A200	265863	
	200	60	160 - 200	6 - 10	NZMN2-4-A200/125	265864
		100	200 - 250	6 - 10	NZMN2-4-A250	265866
	250	60	200 - 250	6 - 10	NZMN2-4-A250/160	265867
		100	240 - 300	5 - 8.3	NZMN2-4-A300	107586
	300	60	240 - 300	5 - 8.3	NZMN2-4-A300/200	107587

1230PIC-702 Symbolphoto



320	100	250 - 320	6 - 10	-	
	60	250 - 320	6 - 10	-	
	100	250 - 320	6 - 10	NZMN3-4-A320	109694
	60	250 - 320	6 - 10	NZMN3-4-A320/200	109695
400	100	320 - 400	6 - 10	-	
	60	320 - 400	6 - 10	-	
	100	320 - 400	6 - 10	NZMN3-4-A400	109696
	60	320 - 400	6 - 10	NZMN3-4-A400/250	109697
500	100	400 - 500	6 - 10	-	
	60	400 - 500	6 - 10	-	
	100	400 - 500	6 - 10	NZMN3-4-A500	109698
	60	400 - 500	6 - 10	NZMN3-4-A500/320	109699



# Compact circuit breakers, switch disconnectors

# 1.5

Circuit breakers IEC, thermomagnetic releases, 4 pole  
NZM...-4-A

Fixed mounting with box terminals  
Part no.

Article no.

Withdrawable units  
Part no.

Article no.

Std. pack

Order base separately

For further terminal types  
see accessories

NZMN1-4-A20	281245	-	1 Off
NZMN1-4-A25	281247	-	
NZMN1-4-A32	281249	-	
NZMN1-4-A40	265811	-	
NZMN1-4-A50	265813	-	
NZMN1-4-A63	265815	-	
NZMN1-4-A80	265817	-	
NZMN1-4-A100	265819	-	
NZMN1-4-A125	265821	-	
NZMN1-4-A160	281251	-	

Terminals as accessory	
NZMN2-4-A160-BT	147393
Terminals as accessory	
NZMN2-4-A200-BT	147394
Terminals as accessory	
NZMN2-4-A250-BT	147395
Terminals as accessory	



NZMN2-4-A125-SVE	113264
NZMN2-4-A160-SVE	113266
NZMN2-4-A160/100-SVE	113267
NZMN2-4-A200-SVE	113269
NZMN2-4-A200/125-SVE	113270
NZMN2-4-A250-SVE	113272
NZMN2-4-A250/160-SVE	113273
-	
-	

Terminals as accessory	



NZMN3-4-A320-SVE	168508
NZMN3-4-A320/200-SVE	168509
NZMN3-4-A320-AVE	113532
NZMN3-4-A320/200-AVE	113533
NZMN3-4-A400-SVE	168510
NZMN3-4-A400/250-SVE	168511
NZMN3-4-A400-AVE	113534
NZMN3-4-A400/250-AVE	113535
NZMN3-4-A500-SVE	168512
NZMN3-4-A500/320-SVE	168513
NZMN3-4-A500-AVE	113536
NZMN3-4-A500/320-AVE	113537

# 1.5

## Compact circuit breakers, switch disconnectors

Circuit breakers IEC, thermomagnetic releases, 4 pole  
NZM...-4-A

Switching capacity 400/415V 50/60 Hz	Rated current = Rated uninterrupted current		Setting range		Fixed mounting with screw terminals	Article no.
	Phase conductor $I_n = I_u$	Neutral conductor $I_n = I_r \times \dots \times$ % of phase conductor	Overload releases $I_r = I_r \times \dots$	Short-circuit releases Non-delayed $I_t = I_t \times \dots$	Part no.	
$I_{cu}$	A	%	A			
kA						



### System and cable protection

- IEC/EN 60947-2

#### Strong switching capacity

1230PIC-784 Symbolphoto



70	20	100	16 - 20	350 A fixed	Screw terminals as accessories	
	25	100	20 - 25	350 A fixed		
	32	100	25 - 32	350 A fixed		
	40	100	32 - 40	8 - 10		
	50	100	40 - 50	6 - 10		
	63	100	50 - 63	6 - 10		
	80	100	63 - 80	6 - 10		
	100	100	80 - 100	6 - 10		
	125	100	100 - 125	6 - 10		
	160	100	125 - 160	1280 A fixed		

1230PIC-801 Symbolphoto



125	100	100 - 125	6 - 10	NZMS2-4-A125	109988
160	100	125 - 160	6 - 10	NZMS2-4-A160	109989
160	60	125 - 160	6 - 10	NZMS2-4-A160/100	109990
200	100	160 - 200	6 - 10	NZMS2-4-A200	109991
200	60	160 - 200	6 - 10	NZMS2-4-A200/125	109992
250	100	200 - 250	6 - 10	NZMS2-4-A250	109993
250	60	200 - 250	6 - 10	NZMS2-4-A250/160	109994
300	100	240 - 300	5 - 8.3	NZMS2-4-A300	110205
300	60	240 - 300	5 - 8.3	NZMS2-4-A300/200	110206

# Compact circuit breakers, switch disconnectors

# 1.5

Circuit breakers IEC, thermomagnetic releases, 4 pole  
NZM...-4-A

**Fixed mounting with box terminals**  
Part no.

Article no.

**Plug-in units**  
Part no.

Article no.

Std. pack

Order base separately

For further terminal types  
see accessories

NZMS1-4-A20	109948	-	1 Off
NZMS1-4-A25	109949		
NZMS1-4-A32	109950		
NZMS1-4-A40	109951		
NZMS1-4-A50	109952		
NZMS1-4-A63	109953		
NZMS1-4-A80	109954		
NZMS1-4-A100	109955		
NZMS1-4-A125	109956		
NZMS1-4-A160	109957		

Terminals as accessory





NZMS2-4-A125-SVE	113313
NZMS2-4-A160-SVE	113314
NZMS2-4-A160/100-SVE	113315
NZMS2-4-A200-SVE	113316
NZMS2-4-A200/125-SVE	113317
NZMS2-4-A250-SVE	113318
NZMS2-4-A250/160-SVE	113319
-	
-	

# 1.5

## Compact circuit breakers, switch disconnectors

Circuit breakers IEC, thermomagnetic releases, 4 pole  
NZM...-4-A

Switching capacity 400/415V 50/60 Hz	Rated current = Rated uninterrupted current		Setting range		Fixed mounting with screw terminals	Article no.
	Phase conductor $I_n = I_u$	Neutral conductor $I_n = I_p \times \dots \times$ % of phase conductor	Overload releases $I_r = I_p \times \dots$	Short-circuit releases Non-delayed $I_s = I_p \times \dots$	Part no.	
$I_{cu}$	A	%	A			
kA						

### System and cable protection

- IEC/EN 60947-2

#### High switching capacity

1230PIC-784 Symbolphoto



100	20	100	15 - 20	350 A fixed	Screw terminals as accessories	
	25	100	20 - 25	350 A fixed		
	32	100	25 - 32	350 A fixed		
	40	100	32 - 40	8 - 10		
	50	100	40 - 50	6 - 10		
	63	100	50 - 63	6 - 10		
	80	100	63 - 80	6 - 10		
	100	100	80 - 100	6 - 10		
	125	100	100 - 125	6 - 10		
160	100	125 - 160	1280 A fixed			

1230PIC-801 Symbolphoto



150	20	100	15 - 20	350 A fixed	NZMH2-4-A20	281287
	25	100	20 - 25	350 A fixed	NZMH2-4-A25	281289
	32	100	25 - 32	350 A fixed	NZMH2-4-A32	281291
	40	100	32 - 40	8 - 10	NZMH2-4-A40	265823
	50	100	40 - 50	6 - 10	NZMH2-4-A50	265825
	63	100	50 - 63	6 - 10	NZMH2-4-A63	265827
	80	100	63 - 80	6 - 10	NZMH2-4-A80	265829
	100	100	80 - 100	6 - 10	NZMH2-4-A100	265831
	125	100	100 - 125	6 - 10	NZMH2-4-A125	265833
	160	100	125 - 160	6 - 10	NZMH2-4-A160	265871
		60	125 - 160	6 - 10	NZMH2-4-A160/100	265872
	200	100	160 - 200	6 - 10	NZMH2-4-A200	265874
		60	160 - 200	6 - 10	NZMH2-4-A200/125	265875
	250	100	200 - 250	6 - 10	NZMH2-4-A250	265877
		60	200 - 250	6 - 10	NZMH2-4-A250/160	265878
300	100	240 - 300	5 - 8.3	NZMH2-4-A300	107588	
	60	240 - 300	5 - 8.3	NZMH2-4-A300/200	107589	

1230PIC-702 Symbolphoto



320	100	250 - 320	6 - 10	NZMH3-4-A320	109700
	60	250 - 320	6 - 10	NZMH3-4-A320/200	109701
	100	250 - 320	6 - 10	-	
	60	250 - 320	6 - 10	-	
400	100	320 - 400	6 - 10	NZMH3-4-A400	109702
	60	320 - 400	6 - 10	NZMH3-4-A400/250	109703
	100	320 - 400	6 - 10	-	
	60	320 - 400	6 - 10	-	
500	100	400 - 500	6 - 10	NZMH3-4-A500	109704
	60	400 - 500	6 - 10	NZMH3-4-A500/320	109705
	100	400 - 500	6 - 10	-	
	60	400 - 500	6 - 10	-	

# Compact circuit breakers, switch disconnectors

# 1.5

Circuit breakers IEC, thermomagnetic releases, 4 pole  
NZM...-4-A

Fixed mounting with box terminals  
Part no.

Article no.

Withdrawable units  
Part no.

Article no.

Std. pack

Order base separately

For further terminal types  
see accessories

NZMH1-4-A20	284416	-	1 Off
NZMH1-4-A25	284418		
NZMH1-4-A32	284420		
NZMH1-4-A40	284422		
NZMH1-4-A50	284424		
NZMH1-4-A63	284426		
NZMH1-4-A80	284428		
NZMH1-4-A100	284430		
NZMH1-4-A125	284432		
NZMH1-4-A160	284434		

Terminals as accessory



NZMH2-4-A20-SVE	113396
NZMH2-4-A25-SVE	113398
NZMH2-4-A32-SVE	113400
NZMH2-4-A40-SVE	113367
NZMH2-4-A50-SVE	113369
NZMH2-4-A63-SVE	113371
NZMH2-4-A80-SVE	113373
NZMH2-4-A100-SVE	113375
NZMH2-4-A125-SVE	113377
NZMH2-4-A160-SVE	113379
NZMH2-4-A160/100-SVE	113380
NZMH2-4-A200-SVE	113382
NZMH2-4-A200/125-SVE	113383
NZMH2-4-A250-SVE	113385
NZMH2-4-A250/160-SVE	113386
-	
-	

Terminals as accessory





NZMH3-4-A320-SVE	168889
NZMH3-4-A320/200-SVE	168890
NZMH3-4-A320-AVE	113578
NZMH3-4-A320/200-AVE	113579
NZMH3-4-A400-SVE	168891
NZMH3-4-A400/250-SVE	168892
NZMH3-4-A400-AVE	113580
NZMH3-4-A400/250-AVE	113581
NZMH3-4-A500-SVE	168893
NZMH3-4-A500/320-SVE	168894
NZMH3-4-A500-AVE	113582
NZMH3-4-A500/320-AVE	113583

# 1.6

## Compact circuit breakers, switch disconnectors

Circuit breakers IEC, electronic releases, 4 pole  
NZM...-4-AX

Switching capacity 400/415V 50/60 Hz	Rated current = Rated uninterrupted current	Neutral conductor $I_n$ x % of phase conductor %	Setting range		Fixed mounting with screw terminals	
			Overload releases	Short-circuit releases Non-delayed	Part no.	Article no.
$I_{cu}$ kA	$I_n = I_u$ A		$I_r = I_n \times \dots$ A	$I_s = I_n \times \dots$ A		
						

### System and cable protection

- IEC/EN 60947-2

#### Normal switching capacity

wa\_ren\_00418\_r Symbolphoto



$I_{cu}$ (kA)	Rated current (A)	$I_n$ x % of phase conductor (%)	Overload releases	Short-circuit releases (A)	Part no.	Article no.
50	40	100	20 - 40	2 - 12	NZMN2-4-AX40	193357
	63	100	25 - 63	2 - 12	NZMN2-4-AX63	193358
	100	100	40 - 100	2 - 12	NZMN2-4-AX100	193359
	160	100	64 - 160	2 - 12	NZMN2-4-AX160	193360
	250	100	100 - 250	2 - 12	NZMN2-4-AX250	193361

wa\_ren\_00918\_r Symbolphoto



400	100	100	160 - 400	2 - 11	NZMN3-4-AX400	191486
	0.60, 100	100	160 - 400	2 - 11	NZMN3-4-AX400/VAR	191487
630	100	100	252 - 630	2 - 8	NZMN3-4-AX630	191488
	0.60, 100	100	252 - 630	2 - 8	NZMN3-4-AX630/VAR	191489

wa\_ren\_01418\_r Symbolphoto



800	100	100	320 - 800	2 - 12	NZMN4-4-AX800	191431
	0.60, 100	100	320 - 800	2 - 12	NZMN4-4-AX800/VAR	191432
1000	100	100	400 - 1000	2 - 12	NZMN4-4-AX1000	191433
	0.60, 100	100	400 - 1000	2 - 12	NZMN4-4-AX1000/VAR	191434
1250	100	100	500 - 1250	2 - 12	NZMN4-4-AX1250	191435
	0.60, 100	100	500 - 1250	2 - 12	NZMN4-4-AX1250/VAR	191436
1600	100	100	640 - 1600	2 - 12	NZMN4-4-AX1600	191437
	0.60, 100	100	640 - 1600	2 - 12	NZMN4-4-AX1600/VAR	191438

#### Strong switching capacity

wa\_ren\_00418\_r Symbolphoto



$I_{cu}$ (kA)	Rated current (A)	$I_n$ x % of phase conductor (%)	Overload releases	Short-circuit releases (A)	Part no.	Article no.
70	40	100	20 - 40	2 - 12	NZMS2-4-AX40	193371
	63	100	25 - 63	2 - 12	NZMS2-4-AX63	193372
	100	100	40 - 100	2 - 12	NZMS2-4-AX100	193373
	160	100	64 - 160	2 - 12	NZMS2-4-AX160	193374
	250	100	100 - 250	2 - 12	NZMS2-4-AX250	193375

wa\_ren\_00918\_r Symbolphoto



400	100	100	160 - 400	2 - 11	NZMS3-4-AX400	191517
	0.60, 100	100	160 - 400	2 - 11	NZMS3-4-AX400/VAR	191518
630	100	100	252 - 630	2 - 8	NZMS3-4-AX630	191519
	0.60, 100	100	252 - 630	2 - 8	NZMS3-4-AX630/VAR	191520

# Compact circuit breakers, switch disconnectors

# 1.6

Circuit breakers IEC, electronic releases, 4 pole  
NZM...-4-AX

**Fixed mounting with box terminals**  
Part no.

Article no.

**Withdrawable units**  
Part no.

Article no.

Std. pack

Order base separately

For further terminal types  
see accessories

Terminals as accessory \_\_\_\_\_ 1 Off

NZMN3-4-AX400-BT	191612
Terminals as accessory	
NZMN3-4-AX630-BT	191613
Terminals as accessory	



NZMN3-4-AX400-AVE	191608
NZMN3-4-AX400/VAR-AVE	191614
NZMN3-4-AX630-AVE	191609
NZMN3-4-AX630/VAR-AVE	191615

Terminals as accessory	_____
	_____
	_____
	_____
	_____
	_____

Withdrawable units as accessory	_____
	_____
	_____
	_____
	_____
	_____

Terminals as accessory \_\_\_\_\_ 1 Off

Terminals as accessory	_____
	_____
	_____





NZMS3-4-AX400-AVE	191529
NZMS3-4-AX400/VAR-AVE	191530
NZMS3-4-AX630-AVE	191531
NZMS3-4-AX630/VAR-AVE	191532

# 1.6

## Compact circuit breakers, switch disconnectors

Circuit breakers IEC, electronic releases, 4 pole  
NZM...-4-AX

Switching capacity 400/415V 50/60 Hz	Rated current = Rated uninterrupted current	Neutral conductor $I_n \times \%$ of phase conductor %	Setting range		Fixed mounting with screw terminals	
			Overload releases	Short-circuit releases Non-delayed	Part no.	Article no.
$I_{cu}$ kA	$I_n = I_u$ A		$I_r = I_n \times \dots$ A	$I_s = I_n \times \dots$ A		
						

### System and cable protection

- IEC/EN 60947-2

#### High switching capacity

wa\_ren\_00418\_r Symbolphoto



150	40	100	20 - 40	2 - 12	NZMH2-4-AX40	193364
	63	100	25 - 63	2 - 12	NZMH2-4-AX63	193365
	100	100	40 - 100	2 - 12	NZMH2-4-AX100	193366
	160	100	64 - 160	2 - 12	NZMH2-4-AX160	193367
	250	100	100 - 250	2 - 12	NZMH2-4-AX250	193368

wa\_ren\_00918\_r Symbolphoto



400	100	160 - 400	2 - 11	NZMH3-4-AX400	191387	
	0.60, 100	160 - 400	2 - 11	NZMH3-4-AX400/VAR	191388	
	630	100	252 - 630	2 - 8	NZMH3-4-AX630	191389
	0.60, 100	252 - 630	2 - 8	NZMH3-4-AX630/VAR	191390	

wa\_ren\_01418\_r Symbolphoto



85	800	100	320 - 800	2 - 12	NZMH4-4-AX800	191473
	0.60, 100	320 - 800	2 - 12	NZMH4-4-AX800/VAR	191474	
	1000	100	400 - 1000	2 - 12	NZMH4-4-AX1000	191475
	0.60, 100	400 - 1000	2 - 12	NZMH4-4-AX1000/VAR	191476	
	1250	100	500 - 1250	2 - 12	NZMH4-4-AX1250	191477
	0.60, 100	500 - 1250	2 - 12	NZMH4-4-AX1250/VAR	191478	
	1600	100	640 - 1600	2 - 12	NZMH4-4-AX1600	191353
	0.60, 100	640 - 1600	2 - 12	NZMH4-4-AX1600/VAR	191354	

#### Limiting switching capacity

wa\_ren\_01418\_r Symbolphoto



100	800	100	320 - 800	2 - 12	NZML4-4-AX800	191331
	0.60, 100	320 - 800	2 - 12	NZML4-4-AX800/VAR	191332	
	1000	100	400 - 1000	2 - 12	NZML4-4-AX1000	191333
	0.60, 100	400 - 1000	2 - 12	NZML4-4-AX1000/VAR	191334	
	1250	100	500 - 1250	2 - 12	NZML4-4-AX1250	191335
	0.60, 100	500 - 1250	2 - 12	NZML4-4-AX1250/VAR	191336	
	1600	100	640 - 1600	2 - 12	NZML4-4-AX1600	191337
	0.60, 100	640 - 1600	2 - 12	NZML4-4-AX1600/VAR	191338	



# Compact circuit breakers, switch disconnectors

# 1.6

Circuit breakers IEC, electronic releases, 4 pole  
NZM...-4-AX

Fixed mounting with box terminals  
Part no.

Article no.

Withdrawable units  
Part no.

Article no.

Std. pack

Order base separately

For further terminal types  
see accessories

Terminals as accessory	_____	_____	1 Off
------------------------	-------	-------	-------

_____
_____
_____
_____

_____
_____
_____
_____

Terminals as accessory	_____		NZMH3-4-AX400-AVE	191375
	_____		NZMH3-4-AX400/VAR-AVE	191379
	_____		NZMH3-4-AX630-AVE	191376
	_____		NZMH3-4-AX630/VAR-AVE	191380

_____
_____
_____
_____
_____
_____
_____

_____
_____
_____
_____
_____
_____
_____

_____	_____	Withdrawable units as accessory	1 Off
-------	-------	---------------------------------	-------

_____
_____
_____
_____
_____
_____
_____

_____
_____
_____
_____
_____
_____
_____

# 1.6

## Compact circuit breakers, switch disconnectors

Circuit breakers IEC, electronic releases, 4 pole  
NZM...-4-VX

Switching capacity 400/415V 50/60 Hz	Rated current = Rated uninterrupted current	Neutral conductor $I_n$ x % of phase conductor %	Setting range			Fixed mounting with screw terminals	
			Overload releases	Short-circuit releases delayed	Short-circuit releases Non-delayed	Part no.	Article no.
$I_{cu}$ kA	$I_n = I_u$ A		$I_r = I_n \times \dots$ A	$I_{sd} = I_n \times \dots$	$I_i = I_n \times \dots$		

### System and cable protection, selectivity and generator protection

• IEC/EN 60947-2

#### Normal switching capacity

wa\_ren\_00618\_r Symbolphoto



50	100	100	40 - 100	2 - 10	2 - 18	NZMN2-4-VX100	191642
	160	100	64 - 160	2 - 10	2 - 18	NZMN2-4-VX160	191643
250	0.60, 100	64 - 160	2 - 10	2 - 18	2 - 18	NZMN2-4-VX160/VAR	191644
	100	100 - 250	2 - 10	2 - 12	2 - 12	NZMN2-4-VX250	191645
	0.60, 100	100 - 250	2 - 10	2 - 12	2 - 12	NZMN2-4-VX250/VAR	191646

wa\_ren\_01118\_r Symbolphoto



400	100	160 - 400	2 - 10	2 - 12	2 - 12	NZMN3-4-VX400	191490
	100	160 - 400	2 - 10	2 - 12	-	-	-
	0.60, 100	160 - 400	2 - 10	2 - 12	2 - 12	NZMN3-4-VX400/VAR	191491
	0.60, 100	160 - 400	2 - 10	2 - 12	2 - 12	-	-
630	100	252 - 630	1.5 - 7	2 - 8	2 - 8	NZMN3-4-VX630	191492
	100	252 - 630	1.5 - 7	2 - 8	-	-	-
	0.60, 100	252 - 630	1.5 - 7	2 - 8	2 - 8	NZMN3-4-VX630/VAR	191493
	0.60, 100	252 - 630	1.5 - 7	2 - 8	2 - 8	-	-

wa\_ren\_01618\_r Symbolphoto



800	100	320 - 800	2 - 10	2 - 18	2 - 18	NZMN4-4-VX800	191439
	0.60, 100	320 - 800	2 - 10	2 - 18	2 - 18	NZMN4-4-VX800/VAR	191440
1000	100	400 - 1000	2 - 10	2 - 18	2 - 18	NZMN4-4-VX1000	191441
	0.60, 100	400 - 1000	2 - 10	2 - 18	2 - 18	NZMN4-4-VX1000/VAR	191442
1250	100	500 - 1250	2 - 10	2 - 15	2 - 15	NZMN4-4-VX1250	191443
	0.60, 100	500 - 1250	2 - 10	2 - 15	2 - 15	NZMN4-4-VX1250/VAR	191444
1600	100	640 - 1600	2 - 10	2 - 12	2 - 12	NZMN4-4-VX1600	191445
	0.60, 100	640 - 1600	2 - 10	2 - 12	2 - 12	NZMN4-4-VX1600/VAR	191446

# Compact circuit breakers, switch disconnectors

# 1.6

## Switch disconnectors IEC, electronic releases, 4 pole NZM...-4-VX

**Fixed mounting with box terminals**  
Part no.

Article no.

**Withdrawable units**  
Part no.

Article no.

Std. pack

Order base separately

For further terminal types  
see accessories

NZMN2-4-VX100-BT	191639
NZMN2-4-VX160-BT	191640
Terminals as accessory	
NZMN2-4-VX250-BT	191641
Terminals as accessory	



NZMN2-4-VX100-SVE	191634	1 Off
NZMN2-4-VX160-SVE	191635	
NZMN2-4-VX160/VAR-SVE	191636	
NZMN2-4-VX250-SVE	191637	
NZMN2-4-VX250/VAR-SVE	191638	

Terminals as accessory	



NZMN3-4-VX400-SVE	191482
NZMN3-4-VX400-AVE	191610
NZMN3-4-VX400/VAR-SVE	191484
NZMN3-4-VX400/VAR-AVE	191616
NZMN3-4-VX630-SVE	191483
NZMN3-4-VX630-AVE	191611
NZMN3-4-VX630/VAR-SVE	191485
NZMN3-4-VX630/VAR-AVE	191617



NZMN4-4-VX800-AVE	193333
Withdrawable units as accessory	
NZMN4-4-VX1000-AVE	193334
Withdrawable units as accessory	
NZMN4-4-VX1250-AVE	193335
Withdrawable units as accessory	
NZMN4-4-VX1600-AVE	193336
Withdrawable units as accessory	

# 1.6

## Compact circuit breakers, switch disconnectors

Circuit breakers IEC, electronic releases, 4 pole  
NZM...-4-VX

Switching capacity 400/415V 50/60 Hz	Rated current = Rated uninterrupted current	Neutral conductor $I_N \times \%$ of phase conductor %	Setting range			Fixed mounting with screw terminals	
			Overload releases	Short-circuit releases delayed	Short-circuit releases Non-delayed	Part no.	Article no.
$I_{cu}$ kA	$I_n = I_u$ A		$I_r = I_n \times \dots$ A	$I_{sd} = I_n \times \dots$	$I_i = I_n \times \dots$		

### System and cable protection, selectivity and generator protection

- IEC/EN 60947-2

#### Strong switching capacity

wa\_ren\_00618\_r Symbolphoto



70	100	100	40 - 100	2 - 10	2 - 18	NZMS2-4-VX100	191659
	160	100	64 - 160	2 - 10	2 - 18	NZMS2-4-VX160	191660
250	0.60, 100	64 - 160	2 - 10	2 - 18	2 - 18	NZMS2-4-VX160/VAR	191661
	100	100 - 250	2 - 10	2 - 12	2 - 12	NZMS2-4-VX250	191662
	0.60, 100	100 - 250	2 - 10	2 - 12	2 - 12	NZMS2-4-VX250/VAR	191663

wa\_ren\_01118\_r Symbolphoto



400	100	160 - 400	2 - 10	2 - 12	2 - 12	NZMS3-4-VX400	191521
	100	160 - 400	2 - 10	2 - 10	2 - 12	-	
	0.60, 100	160 - 400	2 - 10	2 - 10	2 - 12	NZMS3-4-VX400/VAR	191522
	0.60, 100	160 - 400	2 - 10	2 - 10	2 - 12	-	
630	100	252 - 630	1.5 - 7	2 - 8	2 - 8	NZMS3-4-VX630	191523
	100	252 - 630	1.5 - 7	2 - 8	2 - 8	-	
	0.60, 100	252 - 630	1.5 - 7	2 - 8	2 - 8	NZMS3-4-VX630/VAR	191524
	0.60, 100	252 - 630	1.5 - 7	2 - 8	2 - 8	-	

# Compact circuit breakers, switch disconnectors

# 1.6

## Circuit breakers IEC, electronic releases, 4 pole NZM...-4-VX

**Fixed mounting with box terminals**  
Part no.

Article no.

**Plug-in/withdrawable units**  
Part no.

Article no.

Std. pack

Order base separately

For further terminal types  
see accessories

Terminals as accessory

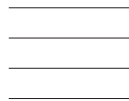

NZMS2-4-VX100-SVE	191664	1 Off
NZMS2-4-VX160-SVE	191665	
NZMS2-4-VX160/VAR-SVE	191666	
NZMS2-4-VX250-SVE	191667	
NZMS2-4-VX250/VAR-SVE	191668	

Terminals as accessory

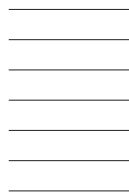

NZMS3-4-VX400-SVE	191541
NZMS3-4-VX400-AVE	191533
NZMS3-4-VX400/VAR-SVE	191542
NZMS3-4-VX400/VAR-AVE	191534
NZMS3-4-VX630-SVE	191543
NZMS3-4-VX630-AVE	191535
NZMS3-4-VX630/VAR-SVE	191544
NZMS3-4-VX630/VAR-AVE	191536

# 1.6

## Compact circuit breakers, switch disconnectors

Circuit breakers IEC, electronic releases, 4 pole  
NZM...-4-VX

Switching capacity 400/415V 50/60 Hz	Rated current = Rated uninterrupted current	Neutral conductor $I_N$ x % of phase conductor %	Setting range			Fixed mounting with screw terminals	
			Overload releases	Short-circuit releases delayed	Short-circuit releases Non-delayed	Part no.	Article no.
$I_{cu}$ kA	$I_n = I_u$ A		$I_r = I_p \times \dots$ A	$I_{sd} = I_p \times \dots$	$I_i = I_p \times \dots$		

### System and cable protection, selectivity and generator protection

- IEC/EN 60947-2

#### High switching capacity

wa\_ren\_00618\_r Symbolphoto



150	100	100	40 - 100	2 - 10	2 - 18	NZMH2-4-VX100	191689
	160	100	64 - 160	2 - 10	2 - 18	NZMH2-4-VX160	191690
250		0.60, 100	64 - 160	2 - 10	2 - 18	NZMH2-4-VX160/VAR	191691
		100	100 - 250	2 - 10	2 - 12	NZMH2-4-VX250	191692
		0.60, 100	100 - 250	2 - 10	2 - 12	NZMH2-4-VX250/VAR	191693

wa\_ren\_01118\_r Symbolphoto



400	100	160 - 400	2 - 10	2 - 12	NZMH3-4-VX400	191391
	100	160 - 400	2 - 10	2 - 12	-	
	0.60, 100	160 - 400	2 - 10	2 - 12	NZMH3-4-VX400/VAR	191392
	0.60, 100	160 - 400	2 - 10	2 - 12	-	
630	100	252 - 630	1.5 - 7	2 - 8	NZMH3-4-VX630	191393
	100	252 - 630	1.5 - 7	2 - 8	-	
	0.60, 100	252 - 630	1.5 - 7	2 - 8	NZMH3-4-VX630/VAR	191394
	0.60, 100	252 - 630	1.5 - 7	2 - 8	-	

wa\_ren\_01618\_r Symbolphoto



85	800	100	320 - 800	2 - 10	2 - 18	NZMH4-4-VX800	191355
		0.60, 100	320 - 800	2 - 10	2 - 18	NZMH4-4-VX800/VAR	191356
1000	100	400 - 1000	2 - 10	2 - 18	NZMH4-4-VX1000	191357	
		0.60, 100	400 - 1000	2 - 10	2 - 18	NZMH4-4-VX1000/VAR	191358
1250	100	500 - 1250	2 - 10	2 - 15	NZMH4-4-VX1250	191359	
		0.60, 100	500 - 1250	2 - 10	2 - 15	NZMH4-4-VX1250/VAR	191360
1600	100	640 - 1600	2 - 10	2 - 12	NZMH4-4-VX1600	191361	
		0.60, 100	640 - 1600	2 - 10	2 - 12	NZMH4-4-VX1600/VAR	191362

# Compact circuit breakers, switch disconnectors

# 1.6

Circuit breakers IEC, electronic releases, 4 pole  
NZM...-4-VX

Fixed mounting with box terminals  
Part no.

Article no.

Plug-in/withdrawable units  
Part no.

Article no.

Std. pack

Order base separately

For further terminal types  
see accessories

Terminals as accessory

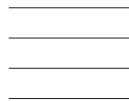

NZMH2-4-VX100-SVE	191684	1 Off
NZMH2-4-VX160-SVE	191685	
NZMH2-4-VX160/VAR-SVE	191686	
NZMH2-4-VX250-SVE	191687	
NZMH2-4-VX250/VAR-SVE	191688	

Terminals as accessory



NZMH3-4-VX400-SVE	191395
NZMH3-4-VX400-AVE	191377
NZMH3-4-VX400/VAR-SVE	191397
NZMH3-4-VX400/VAR-AVE	191381
NZMH3-4-VX630-SVE	191396
NZMH3-4-VX630-AVE	191378
NZMH3-4-VX630/VAR-SVE	191398
NZMH3-4-VX630/VAR-AVE	191382

-

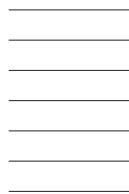



NZMH4-4-VX800-AVE	193337
Withdrawable units as accessory	
NZMH4-4-VX1000-AVE	193338
Withdrawable units as accessory	
NZMH4-4-VX1250-AVE	193339
Withdrawable units as accessory	
NZMH4-4-VX1600-AVE	193340
Withdrawable units as accessory	

# 1.6

## Compact circuit breakers, switch disconnectors

Circuit breakers IEC, electronic releases, 4 pole  
NZM...-4-VX...-T

Switching capacity 400/415V 50/60 Hz	Rated current = Rated uninterrupted current	Neutral conductor $I_N$ x % of phase conductor %	Setting range				Fixed mounting with screw terminals	
			Overload releases	Short-circuit releases delayed	Short-circuit releases Non-delayed	Earth-fault release	Part no.	Article no.
$I_{cu}$ kA	$I_n = I_u$ A		$I_r = I_n \times \dots$ A	$I_{sd} = I_r \times \dots$	$I_s = I_n \times \dots$	$I_G = I_n \times \dots$		
								

### System and cable protection, selectivity, generator and earth fault protection

• IEC/EN 60947-2

#### Normal switching capacity

wa\_ren\_00218\_r Symbolphoto



50	40	100	20 - 40	2 - 10	2 - 18	20 - 40	NZMN2-4-VX40-T	193299
	63	100	25 - 63	2 - 10	2 - 18	20 - 63	NZMN2-4-VX63-T	193300
	100	100	40 - 100	2 - 10	2 - 18	20 - 100	NZMN2-4-VX100-T	193301
	160	100	64 - 160	2 - 10	2 - 18	32 - 160	NZMN2-4-VX160-T	193302
	250	100	100 - 250	2 - 10	2 - 12	50 - 250	NZMN2-4-VX250-T	193303

wa\_ren\_01218\_r Symbolphoto



400	100	160 - 400	2 - 10	2 - 12	80 - 400	NZMN3-4-VX400-T	191480
630	100	252 - 630	1.5 - 7	2 - 8	126 - 630	NZMN3-4-VX630-T	191481

wa\_ren\_01718\_r Symbolphoto



800	100	320 - 800	2 - 10	2 - 18	160 - 800	NZMN4-4-VX800-T	193320
1000	100	400 - 1000	2 - 10	2 - 18	200 - 1000	NZMN4-4-VX1000-T	193321
1250	100	500 - 1250	2 - 10	2 - 15	250 - 1250	NZMN4-4-VX1250-T	193322
1600	100	640 - 1600	2 - 10	2 - 12	320 - 1600	NZMN4-4-VX1600-T	193323

#### Strong switching capacity

wa\_ren\_01218\_r Symbolphoto



70	400	100	160 - 400	2 - 10	2 - 12	80 - 400	NZMS3-4-VX400-T	191525
		0.60, 100	160 - 400	2 - 10	2 - 12	80 - 400	NZMS3-4-VX400/VAR-T	191526
630	100	252 - 630	1.5 - 7	2 - 8	126 - 630	NZMS3-4-VX630-T	191527	
		0.60, 100	252 - 630	1.5 - 7	2 - 8	126 - 630	NZMS3-4-VX630/VAR-T	191528



# Compact circuit breakers, switch disconnectors

# 1.6

Circuit breakers IEC, electronic releases, 4 pole  
NZM...-4-VX...-T

Fixed mounting with box terminals  
Part no.

Article no.

Plug-in/withdrawable units  
Part no.

Article no.

Std. pack

Order base separately

For further terminal types  
see accessories

Terminals as accessory	_____	-	_____	1 Off
	_____		_____	
	_____		_____	
	_____		_____	

Terminals as accessory	_____		NZMN3-4-VX400-T-AVE	191618	1 Off
	_____		NZMN3-4-VX630-T-AVE	191479	



-	_____	Withdrawable units as accessory	_____	1 Off
	_____		_____	
	_____		_____	

Terminals as accessory	_____		NZMS3-4-VX400-T-AVE	191537	1 Off
	_____		NZMS3-4-VX400/VAR-T-AVE	191538	
	_____		NZMS3-4-VX630-T-AVE	191539	
	_____		NZMS3-4-VX630/VAR-T-AVE	191540	

# 1.6

## Compact circuit breakers, switch disconnectors

Circuit breakers IEC, electronic releases, 4 pole  
NZM...-4-VX...-T

Switching capacity 400/415V 50/60 Hz	Rated current = Rated uninterrupted current	Neutral conductor $I_n$ x % of phase conductor %	Setting range				Fixed mounting with screw terminals	
			Overload releases	Short-circuit releases delayed	Short-circuit releases Non-delayed	Earth-fault release	Part no.	Article no.
$I_{cu}$ kA	$I_n = I_u$ A		$I_r = I_n \times \dots$ A	$I_{sd} = I_r \times \dots$	$I_s = I_r \times \dots$	$I_G = I_n \times \dots$		
								

### System and cable protection, selectivity, generator and earth fault protection

- IEC/EN 60947-2

#### High switching capacity

wa\_ren\_00218\_r Symbolphoto



150	40	100	20 - 40	2 - 10	2 - 18	20 - 40	NZMH2-4-VX40-T	193305
	63	100	25 - 63	2 - 10	2 - 18	20 - 63	NZMH2-4-VX63-T	193306
	100	100	40 - 100	2 - 10	2 - 18	20 - 100	NZMH2-4-VX100-T	193307
	160	100	64 - 160	2 - 10	2 - 18	32 - 160	NZMH2-4-VX160-T	193308
	250	100	100 - 250	2 - 10	2 - 12	50 - 250	NZMH2-4-VX250-T	193309

wa\_ren\_01218\_r Symbolphoto



400	100	160 - 400	2 - 10	2 - 12	80 - 400	NZMH3-4-VX400-T	191385
630	100	252 - 630	1.5 - 7	2 - 8	126 - 630	NZMH3-4-VX630-T	191386

wa\_ren\_01718\_r Symbolphoto



85	800	100	320 - 800	2 - 10	2 - 18	160 - 800	NZMH4-4-VX800-T	193324
	1000	100	400 - 1000	2 - 10	2 - 18	200 - 1000	NZMH4-4-VX1000-T	193325
	1250	100	500 - 1250	2 - 10	2 - 15	250 - 1250	NZMH4-4-VX1250-T	193326
	1600	100	640 - 1600	2 - 10	2 - 12	320 - 1600	NZMH4-4-VX1600-T	193327

# Compact circuit breakers, switch disconnectors

# 1.6

Circuit breakers IEC, electronic releases, 4 pole  
NZM...-4-VX...-T

**Fixed mounting with box terminals**  
Part no.

Article no.

**Plug-in/withdrawable units**  
Part no.

Article no. Std. pack

Order base separately

For further terminal types  
see accessories

Terminals as accessory	_____	-	_____	1 Off
	_____		_____	
	_____		_____	
	_____		_____	

Terminals as accessory	_____	NZMH3-4-VX400-T-AVE	191383	1 Off
		NZMH3-4-VX630-T-AVE	191384	



-	_____	Withdrawable units as accessory	_____	1 Off
	_____		_____	
	_____		_____	

# 1.7

## Compact circuit breakers, switch disconnectors

Circuit breakers IEC, electronic releases with energy meter function, 4 pole  
NZM...PX

Switching capacity 400/415V 50/60 Hz	Rated current = Rated uninterrupted current	Neutral conductor $I_N \times \%$ of phase conductor	Setting range			Fixed mounting with screw terminals	
			Overload releases	Short-circuit releases delayed	Short-circuit releases Non-delayed	Part no.	Article no.
$I_{cu}$ kA	$I_n = I_u$ A		$I_r = I_p \times \dots$ A	$I_{sd} = I_p \times \dots$	$I_s = I_p \times \dots$		

### System and cable protection

- IEC/EN 60947-2

#### Normal switching capacity

wa\_ren\_00318\_r Symbolphoto



50	40	0.60, 100	20 - 40	2 - 10	2 - 18	NZMN2-4-PX40/VAR	192204
	63	0.60, 100	25 - 63	2 - 10	2 - 18	NZMN2-4-PX63/VAR	192205
	100	0.60, 100	40 - 100	2 - 10	2 - 18	NZMN2-4-PX100/VAR	192206
	160	0.60, 100	64 - 160	2 - 10	2 - 18	NZMN2-4-PX160/VAR	192207
	250	0.60, 100	100 - 250	2 - 10	2 - 12	NZMN2-4-PX250/VAR	192208

wa\_ren\_00818\_r Symbolphoto



250	0.60, 100	100 - 250	2 - 10	2 - 18	NZMN3-4-PX250/VAR	192277
	0.60, 100	100 - 250	2 - 10	2 - 18	-	
400	0.60, 100	160 - 400	2 - 10	2 - 12	NZMN3-4-PX400/VAR	192278
	0.60, 100	160 - 400	2 - 10	2 - 12	-	
630	0.60, 100	252 - 630	1.5 - 7	2 - 8	NZMN3-4-PX630/VAR	192279
	0.60, 100	252 - 630	1.5 - 7	2 - 8	-	

wa\_ren\_01818\_r Symbolphoto



630	0.60, 100	252 - 630	2 - 10	2 - 12	NZMN4-4-PX630/VAR	189641
800	0.60, 100	320 - 800	2 - 10	2 - 18	NZMN4-4-PX800/VAR	189642
1000	0.60, 100	500 - 1000	2 - 10	2 - 12	NZMN4-4-PX1000/VAR	189643
1250	0.60, 100	630 - 1250	2 - 10	2 - 12	NZMN4-4-PX1250/VAR	189644
1600	0.60, 100	800 - 1600	2 - 10	2 - 12	NZMN4-4-PX1600/VAR	189645

#### Strong switching capacity

wa\_ren\_00318\_r Symbolphoto



70	40	0.60, 100	20 - 40	2 - 10	2 - 18	NZMS2-4-PX40/VAR	192211
	63	0.60, 100	25 - 63	2 - 10	2 - 18	NZMS2-4-PX63/VAR	192212
	100	0.60, 100	40 - 100	2 - 10	2 - 18	NZMS2-4-PX100/VAR	192213
	160	0.60, 100	64 - 160	2 - 10	2 - 18	NZMS2-4-PX160/VAR	192214
	250	0.60, 100	100 - 250	2 - 10	2 - 12	NZMS2-4-PX250/VAR	192215

wa\_ren\_00818\_r Symbolphoto



250	0.60, 100	100 - 250	2 - 10	2 - 18	NZMS3-4-PX250/VAR	192280
	0.60, 100	100 - 250	2 - 10	2 - 18	-	
400	0.60, 100	160 - 400	2 - 10	2 - 12	NZMS3-4-PX400/VAR	192281
	0.60, 100	160 - 400	2 - 10	2 - 12	-	
630	0.60, 100	252 - 630	1.5 - 7	2 - 8	NZMS3-4-PX630/VAR	192282
	0.60, 100	252 - 630	1.5 - 7	2 - 8	-	

# Compact circuit breakers, switch disconnectors

Circuit breakers IEC, electronic releases with energy meter function, 3 pole  
NZM...PX

# 1.7

Fixed mounting with box terminals  
Part no.

Article no.

Plug-in/withdrawable units  
Part no.

Article no.

Std. pack

Order base separately

For further terminal types  
see accessories

Terminals as accessory

\_\_\_\_\_

\_\_\_\_\_

\_\_\_\_\_

\_\_\_\_\_



NZMN2-4-PX40/VAR-SVE	192062	1 Off
NZMN2-4-PX63/VAR-SVE	192063	
NZMN2-4-PX100/VAR-SVE	192064	
NZMN2-4-PX160/VAR-SVE	192065	
NZMN2-4-PX250/VAR-SVE	192066	

Terminals as accessory

\_\_\_\_\_

\_\_\_\_\_

\_\_\_\_\_

\_\_\_\_\_



NZMN3-4-PX250/VAR-SVE	192295
NZMN3-4-PX250/VAR-AVE	192304
NZMN3-4-PX400/VAR-SVE	192296
NZMN3-4-PX400/VAR-AVE	192305
NZMN3-4-PX630/VAR-SVE	192297
NZMN3-4-PX630/VAR-AVE	192306

-

\_\_\_\_\_

\_\_\_\_\_

\_\_\_\_\_

\_\_\_\_\_



NZMN4-4-PX630/VAR-AVE	189661
NZMN4-4-PX800/VAR-AVE	189662
NZMN4-4-PX1000/VAR-AVE	189663
NZMN4-4-PX1250/VAR-AVE	189664
NZMN4-4-PX1600/VAR-AVE	189665

Terminals as accessory

\_\_\_\_\_

\_\_\_\_\_

\_\_\_\_\_

\_\_\_\_\_



NZMS2-4-PX40/VAR-SVE	192069	1 Off
NZMS2-4-PX63/VAR-SVE	192070	
NZMS2-4-PX100/VAR-SVE	192071	
NZMS2-4-PX160/VAR-SVE	192072	
NZMS2-4-PX250/VAR-SVE	192073	

Terminals as accessory

\_\_\_\_\_

\_\_\_\_\_

\_\_\_\_\_

\_\_\_\_\_



NZMS3-4-PX250/VAR-SVE	192298
NZMS3-4-PX250/VAR-AVE	192307
NZMS3-4-PX400/VAR-SVE	192299
NZMS3-4-PX400/VAR-AVE	192308
NZMS3-4-PX630/VAR-SVE	192300
NZMS3-4-PX630/VAR-AVE	192309

# 1.7

## Compact circuit breakers, switch disconnectors

Circuit breakers IEC, electronic releases with energy meter function, 3 pole NZM...PX

Switching capacity 400/415V 50/60 Hz	Rated current = Rated uninterrupted current	Neutral conductor $I_N \times \%$ of phase conductor %	Setting range			Fixed mounting with screw terminals	
			Overload releases	Short-circuit releases delayed	Short-circuit releases Non-delayed	Part no.	Article no.
$I_{cu}$ kA	$I_n = I_u$ A		$I_r = I_n \times \dots$ A	$I_{sd} = I_n \times \dots$	$I_s = I_n \times \dots$		

### System and cable protection, selectivity and generator protection

- IEC/EN 60947-2

#### High switching capacity

wa\_ren\_00318\_r Symbolphoto



150	40	0.60, 100	20 - 40	2 - 10	2 - 18	NZMH2-4-PX40/VAR	192218
	63	0.60, 100	25 - 63	2 - 10	2 - 18	NZMH2-4-PX63/VAR	192219
	100	0.60, 100	40 - 100	2 - 10	2 - 18	NZMH2-4-PX100/VAR	192220
	160	0.60, 100	64 - 160	2 - 10	2 - 18	NZMH2-4-PX160/VAR	192221
	250	0.60, 100	100 - 250	2 - 10	2 - 12	NZMH2-4-PX250/VAR	192222

wa\_ren\_00818\_r Symbolphoto



250	250	0.60, 100	100 - 250	2 - 10	2 - 18	NZMH3-4-PX250/VAR	192283
		0.60, 100	100 - 250	2 - 10	2 - 18	-	
	400	0.60, 100	160 - 400	2 - 10	2 - 12	NZMH3-4-PX400/VAR	192284
		0.60, 100	160 - 400	2 - 10	2 - 12	-	
630	630	0.60, 100	252 - 630	1.5 - 7	2 - 8	NZMH3-4-PX630/VAR	192285
		0.60, 100	252 - 630	1.5 - 7	2 - 8	-	

wa\_ren\_01818\_r Symbolphoto



85	630	0.60, 100	252 - 630	2 - 10	2 - 18	NZMH4-4-PX630/VAR	189646
	800	0.60, 100	320 - 800	2 - 10	2 - 18	NZMH4-4-PX800/VAR	189647
	1000	0.60, 100	500 - 1000	2 - 10	2 - 18	NZMH4-4-PX1000/VAR	189648
	1250	0.60, 100	630 - 1250	2 - 10	2 - 15	NZMH4-4-PX1250/VAR	189649
	1600	0.60, 100	800 - 1600	2 - 10	2 - 12	NZMH4-4-PX1600/VAR	189650

# Compact circuit breakers, switch disconnectors

# 1.7

Circuit breakers IEC, electronic releases with energy meter function, 3 pole  
NZM...PX

**Fixed mounting with box terminals**  
Part no.

Article no.

**Plug-in/withdrawable units**  
Part no.

Article no.

Std. pack

Order base separately

For further terminal types  
see accessories

Terminals as accessory

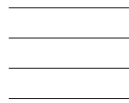

NZMH2-4-PX40/VAR-SVE	192076	1 Off
NZMH2-4-PX63/VAR-SVE	192077	
NZMH2-4-PX100/VAR-SVE	192078	
NZMH2-4-PX160/VAR-SVE	192079	
NZMH2-4-PX250/VAR-SVE	192080	

Terminals as accessory



NZMH3-4-PX250/VAR-SVE	192301
NZMH3-4-PX250/VAR-AVE	192310
NZMH3-4-PX400/VAR-SVE	192302
NZMH3-4-PX400/VAR-AVE	192311
NZMH3-4-PX630/VAR-SVE	192303
NZMH3-4-PX630/VAR-AVE	192312

-

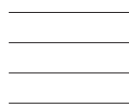

NZMH4-4-PX630/VAR-AVE	189666
NZMH4-4-PX800/VAR-AVE	189667
NZMH4-4-PX1000/VAR-AVE	189668
NZMH4-4-PX1250/VAR-AVE	189669
NZMH4-4-PX1600/VAR-AVE	189670

# 1.7

## Compact circuit breakers, switch disconnectors

Circuit breakers IEC, electronic releases with energy meter function, 3 pole NZM...PX...-TZ, ...-TAZ

Switching capacity 400/415V 50/60 Hz	Rated current = Rated uninterrupted current	Neutral conductor $I_N$ x % of phase conductor %	Setting range				Fixed mounting with screw terminals	
			Overload releases	Short-circuit releases delayed	Short-circuit releases Non-delayed	Earth-fault release	Part no.	Article no.
$I_{cu}$ kA	$I_n = I_u$ A		$I_r = I_n \times \dots$ A	$I_{sd} = I_r \times \dots$	$I_s = I_n \times \dots$	$I_G = I_n \times \dots$		

### System and cable protection, selectivity, generator and earth fault protection

- Energy metering class I up to IEC61557-12
- IEC/EN 60947-2
- NZM3, NZM4: with maintenance mode ARMs and zone-selective interlocking ZSI
- NZM2: with zone-selective interlocking ZSI

#### Normal switching capacity

wa\_ren\_00318\_r Symbolphoto



50	40	0.60, 100	20 - 40	2 - 10	2 - 18	20 - 40	NZMN2-4-PX40/VAR-TZ	192225
	63	0.60, 100	25 - 63	2 - 10	2 - 18	20 - 63	NZMN2-4-PX63/VAR-TZ	192226
	100	0.60, 100	40 - 100	2 - 10	2 - 18	20 - 100	NZMN2-4-PX100/VAR-TZ	192227
	160	0.60, 100	64 - 160	2 - 10	2 - 18	32 - 160	NZMN2-4-PX160/VAR-TZ	192228
	250	0.60, 100	100 - 250	2 - 10	2 - 12	50 - 250	NZMN2-4-PX250/VAR-TZ	192229

wa\_ren\_00818\_r Symbolphoto



250	0.60, 100	100 - 250	2 - 10	2 - 18	50 - 250	NZMN3-4-PX250/VAR-TAZ	192286
400	0.60, 100	160 - 400	2 - 10	2 - 12	80 - 400	NZMN3-4-PX400/VAR-TAZ	192287
630	0.60, 100	252 - 630	1.5 - 7	2 - 8	126 - 630	NZMN3-4-PX630/VAR-TAZ	192288

wa\_ren\_01818\_r Symbolphoto



630	0.60, 100	252 - 630	2 - 10	2 - 18	126 - 630	NZMN4-4-PX630/VAR-TAZ	189651
800	0.60, 100	320 - 800	2 - 10	2 - 18	160 - 800	NZMN4-4-PX800/VAR-TAZ	189652
1000	0.60, 100	400 - 1000	2 - 10	2 - 18	200 - 1000	NZMN4-4-PX1000/VAR-TAZ	189653
1250	0.60, 100	500 - 1250	2 - 10	2 - 15	250 - 1250	NZMN4-4-PX1250/VAR-TAZ	189654
1600	0.60, 100	640 - 1600	2 - 10	2 - 12	320 - 1600	NZMN4-4-PX1600/VAR-TAZ	189655

#### Strong switching capacity

wa\_ren\_00318\_r Symbolphoto



70	40	0.60, 100	20 - 40	2 - 10	2 - 18	20 - 40	NZMS2-4-PX40/VAR-TZ	192232
	63	0.60, 100	25 - 63	2 - 10	2 - 18	20 - 63	NZMS2-4-PX63/VAR-TZ	192233
	100	0.60, 100	40 - 100	2 - 10	2 - 18	20 - 100	NZMS2-4-PX100/VAR-TZ	192234
	160	0.60, 100	64 - 160	2 - 10	2 - 18	32 - 160	NZMS2-4-PX160/VAR-TZ	192235
	250	0.60, 100	100 - 250	2 - 10	2 - 12	50 - 250	NZMS2-4-PX250/VAR-TZ	192236

wa\_ren\_00818\_r Symbolphoto



250	0.60, 100	100 - 250	2 - 10	2 - 18	50 - 250	NZMS3-4-PX250/VAR-TAZ	192289
400	0.60, 100	160 - 400	2 - 10	2 - 12	80 - 400	NZMS3-4-PX400/VAR-TAZ	192290
630	0.60, 100	252 - 630	1.5 - 7	2 - 8	126 - 630	NZMS3-4-PX630/VAR-TAZ	192291



# Compact circuit breakers, switch disconnectors

# 1.7

Circuit breakers IEC, electronic releases with energy meter function, 3 pole  
 NZM...PX...-TZ, ...-TAZ

### Fixed mounting with box terminals

Part no.

Article no.

### Plug-in/withdrawable units

Part no.

Article no.

Std. pack

Order base separately

For further terminal types  
 see accessories

Terminals as accessory

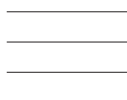

NZMN2-4-PX40/VAR-TZ-SVE	192083	1 Off
NZMN2-4-PX63/VAR-TZ-SVE	192084	
NZMN2-4-PX100/VAR-TZ-SVE	192085	
NZMN2-4-PX160/VAR-TZ-SVE	192086	
NZMN2-4-PX250/VAR-TZ-SVE	192087	

Terminals as accessory



NZMN3-4-PX250/VAR-TAZ-AVE	192313
NZMN3-4-PX400/VAR-TAZ-AVE	192314
NZMN3-4-PX630/VAR-TAZ-AVE	192315

-

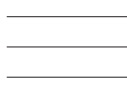

NZMN4-4-PX630/VAR-TAZ-AVE	189671
NZMN4-4-PX800/VAR-TAZ-AVE	189672
NZMN4-4-PX1000/VAR-TAZ-AVE	189673
NZMN4-4-PX1250/VAR-TAZ-AVE	189674
NZMN4-4-PX1600/VAR-TAZ-AVE	189675

Terminals as accessory

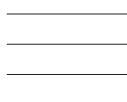

NZMS2-4-PX40/VAR-TZ-SVE	192090	1 Off
NZMS2-4-PX63/VAR-TZ-SVE	192091	
NZMS2-4-PX100/VAR-TZ-SVE	192092	
NZMS2-4-PX160/VAR-TZ-SVE	192093	
NZMS2-4-PX250/VAR-TZ-SVE	192094	

Terminals as accessory



NZMS3-4-PX250/VAR-TAZ-AVE	192316
NZMS3-4-PX400/VAR-TAZ-AVE	192317
NZMS3-4-PX630/VAR-TAZ-AVE	192318

# 1.7

## Compact circuit breakers, switch disconnectors

Circuit breakers IEC, electronic releases with energy meter function, 3 pole  
 NZM...PX...-TZ, ...-TAZ

Switching capacity 400/415V 50/60 Hz	Rated current = Rated uninterrupted current	Neutral conductor $I_N$ x % of phase conductor %	Setting range				Fixed mounting with screw terminals	
			Overload releases	Short-circuit releases delayed	Short-circuit releases Non-delayed	Earth-fault release	Part no.	Article no.
$I_{cu}$ kA	$I_n = I_u$ A		$I_r = I_n \times \dots$ A	$I_{sd} = I_r \times \dots$	$I_s = I_n \times \dots$	$I_G = I_n \times \dots$		

### System and cable protection, selectivity, generator and earth fault protection

- Energy metering class I up to IEC61557-12
- IEC/EN 60947-2
- NZM3, NZM4: with maintenance mode ARMs and zone-selective interlocking ZSI
- NZM2: with zone-selective interlocking ZSI

#### Normal switching capacity

wa\_ren\_00318\_r Symbolphoto



150	40	0.60, 100	20 - 40	2 - 10	2 - 18	20 - 40	NZMH2-4-PX40/VAR-TZ	192055
	63	0.60, 100	25 - 63	2 - 10	2 - 18	20 - 63	NZMH2-4-PX63/VAR-TZ	192056
	100	0.60, 100	40 - 100	2 - 10	2 - 18	20 - 100	NZMH2-4-PX100/VAR-TZ	192057
	160	0.60, 100	64 - 160	2 - 10	2 - 18	32 - 160	NZMH2-4-PX160/VAR-TZ	192058
	250	0.60, 100	100 - 250	2 - 10	2 - 12	50 - 250	NZMH2-4-PX250/VAR-TZ	192059

wa\_ren\_00818\_r Symbolphoto



250	0.60, 100	100 - 250	2 - 10	2 - 18	50 - 250	NZMH3-4-PX250/VAR-TAZ	192292
400	0.60, 100	160 - 400	2 - 10	2 - 12	80 - 400	NZMH3-4-PX400/VAR-TAZ	192293
630	0.60, 100	252 - 630	1.5 - 7	2 - 8	126 - 630	NZMH3-4-PX630/VAR-TAZ	192294

wa\_ren\_01818\_r Symbolphoto



85	630	0.60, 100	252 - 630	2 - 10	2 - 18	126 - 630	NZMH4-4-PX630/VAR-TAZ	189656
	800	0.60, 100	320 - 800	2 - 10	2 - 18	160 - 800	NZMH4-4-PX800/VAR-TAZ	189657
	1000	0.60, 100	400 - 1000	2 - 10	2 - 18	200 - 1000	NZMH4-4-PX1000/VAR-TAZ	189658
	1250	0.60, 100	500 - 1250	2 - 10	2 - 15	250 - 1250	NZMH4-4-PX1250/VAR-TAZ	189659
	1600	0.60, 100	640 - 1600	2 - 10	2 - 12	320 - 1600	NZMH4-4-PX1600/VAR-TAZ	189660

# Compact circuit breakers, switch disconnectors

# 1.7

Circuit breakers IEC, electronic releases with energy meter function, 3 pole

NZM...PX...-TZ, ...-TAZ

Fixed mounting with box terminals  
Part no.

Article no.

Plug-in/withdrawable units  
Part no.

Article no.

Std. pack

Order base separately

For further terminal types  
see accessories

Terminals as accessory

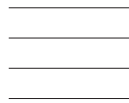

NZMH2-4-PX40/VAR-TZ-SVE	192097	1 Off
NZMH2-4-PX63/VAR-TZ-SVE	192098	
NZMH2-4-PX100/VAR-TZ-SVE	192099	
NZMH2-4-PX160/VAR-TZ-SVE	192100	
NZMH2-4-PX250/VAR-TZ-SVE	192101	

Terminals as accessory



NZMH3-4-PX250/VAR-TAZ-AVE	192319
NZMH3-4-PX400/VAR-TAZ-AVE	192320
NZMH3-4-PX630/VAR-TAZ-AVE	192321

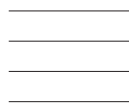



NZMH4-4-PX630/VAR-TAZ-AVE	189676
NZMH4-4-PX800/VAR-TAZ-AVE	189677
NZMH4-4-PX1000/VAR-TAZ-AVE	189678
NZMH4-4-PX1250/VAR-TAZ-AVE	189679
NZMH4-4-PX1600/VAR-TAZ-AVE	189680

# 1.8

## Compact circuit breakers, switch disconnectors

Compact circuit breakers IEC, thermomagnetic releases, 1 pole  
NZM...AF

Switching capacity 230V 50/60 Hz	Rated current = Rated uninterrupted current	Setting range		Fixed mounting with box terminals		
		Overload releases	Short-circuit releases Non-delayed	Part no.	Article no.	Std. pack
$I_{cu}$ kA	$I_n = I_u$ A	$I_r = I_n \times \dots$ A	$I_i$			
						

### System and cable protection

- IEC/EN 60947-2

#### Economy switching capacity

1230PIC-471 Symbolphoto



18						
	16	16 A fixed	320 A fixed	NZME1-1-AF16	152561	1 Off
	20	20 A fixed	320 A fixed	NZME1-1-AF20	152540	
	25	25 A fixed	320 A fixed	NZME1-1-AF25	152541	
	32	32 A fixed	340 A fixed	NZME1-1-AF32	152542	
	40	40 A fixed	340 A fixed	NZME1-1-AF40	152543	
	50	50 A fixed	600 A fixed	NZME1-1-AF50	152544	
	63	63 A fixed	600 A fixed	NZME1-1-AF63	152545	
	80	80 A fixed	1000 A fixed	NZME1-1-AF80	152546	
	100	100 A fixed	1000 A fixed	NZME1-1-AF100	152547	
	125	125 A fixed	1000 A fixed	NZME1-1-AF125	152548	

#### Basic switching capacity

1230PIC-471 Symbolphoto



25						
	16	16 A fixed	320 A fixed	NZMB1-1-AF16	152560	1 Off
	20	20 A fixed	320 A fixed	NZMB1-1-AF20	152531	
	25	25 A fixed	320 A fixed	NZMB1-1-AF25	152532	
	32	32 A fixed	340 A fixed	NZMB1-1-AF32	152533	
	40	40 A fixed	340 A fixed	NZMB1-1-AF40	152534	
	50	50 A fixed	600 A fixed	NZMB1-1-AF50	152535	
	63	63 A fixed	600 A fixed	NZMB1-1-AF63	152536	
	80	80 A fixed	1000 A fixed	NZMB1-1-AF80	152537	
	100	100 A fixed	1000 A fixed	NZMB1-1-AF100	152538	
	125	125 A fixed	1000 A fixed	NZMB1-1-AF125	152539	

Rated current = Rated uninter- rupted current	Short-circuit protection max. fuse gL- characteristic	Fixed mounting with screw terminals		Fixed mounting with box terminals		Std. pack
		Part no.	Article no.	Part no.	Article no.	
$I_n = I_u$ A	A gL					

### Switch disconnectors

- IEC/EN 60947-2

For further terminal types  
see accessories

#### 2 switch positions I, 0

1230PIC-752 Symbolphoto



63	125	-			PN1-63	259140	1 Off
100	125				PN1-100	259141	
125	125				PN1-125	259142	
160	160				PN1-160	281235	

1230PIC-796 Symbolphoto



160	250	PN2-160	266005	PN2-160-BT	110308	
200	250	PN2-200	266006	PN2-200-BT	110309	
250	250	PN2-250	266007	PN2-250-BT	110310	

1230PIC-671 Symbolphoto



400	630	PN3-400	266017	PN3-400-BT	110314	
630	630	PN3-630	266018	PN3-630-BT	110315	

# 1.9

## Compact circuit breakers, switch disconnectors

Switch disconnectors IEC, 3 pole  
PN..., N...

Rated current = Rated uninterrupted current	Short-circuit protection max. fuse gL-characteristic	Fixed mounting with screw terminals Part no.	Article no.
$I_n = I_u$ A	A gL		

### Switch disconnectors

- IEC/EN 60947-2

#### 3 switch positions I, +, 0

Can be remotely operated with shunt release XU/XA, remote operator XR  
Can be equipped with trip-indicating auxiliary contact M22-K..

1230PIC-752 Symbolphoto



63	125	Screw terminals	
100	125	as accessories	
125	125		
160	160		

1230PIC-796 Symbolphoto



160	250	N2-160	266008
200	250	N2-200	266009
250	250	N2-250	266010

1230PIC-671 Symbolphoto



400	630	N3-400	266019
630	630	N3-630	266020

1230PIC-674 Symbolphoto



800	1600	N4-800	266025
1000	1600	N4-1000	266026
1250	1600	N4-1250	266027
1600	1600	N4-1600	266028

# Compact circuit breakers, switch disconnectors

# 1.9

Switch disconnectors IEC, 3 pole  
PN..., N...

**Fixed mounting with box terminals**  
Part no.

Article no.

**Plug-in/withdrawable units**  
Part no.

Article no.

Std. pack

For further terminal types  
see accessories

N1-63	259143
N1-100	259144
N1-125	259145
N1-160	281236



N1-63-SVE	113729	1 Off
N1-100-SVE	113730	
N1-125-SVE	113731	
-		

N2-160-BT	110311
N2-200-BT	110312
N2-250-BT	110313



N2-160-SVE	113733
N2-200-SVE	113734
N2-250-SVE	113735

N3-400-BT	110316
-	
N3-630-BT	110317
-	



N3-400-SVE	168544
N3-400-AVE	110768
N3-630-SVE	168545
N3-630-AVE	110769

Withdrawable units as accessory

\_\_\_\_\_  
\_\_\_\_\_  
\_\_\_\_\_

\_\_\_\_\_  
\_\_\_\_\_  
\_\_\_\_\_

# 1.10

## Compact circuit breakers, switch disconnectors





Rated current = Rated uninter- rupted current	Short-circuit protection max. fuse gL- characteristic	Fixed mounting with screw terminals		Fixed mounting with box terminals		Std. pack
		Part no.	Article no.	Part no.	Article no.	
$I_n = I_u$ A	A gL					

### Switch disconnectors

- IEC/EN 60947-2

For further terminal types  
see accessories

#### 2 switch positions I, 0

1230PIC-751 Symbolphoto



63	125	-		PN1-4-63	265999	1 Off
100	125			PN1-4-100	266000	
125	125			PN1-4-125	266001	
160	160			PN1-4-160	281253	

1230PIC-797 Symbolphoto



160	250	PN2-4-160	266011	PN2-4-160-BT	118880	
200	250	PN2-4-200	266012	PN2-4-200-BT	118881	
250	250	PN2-4-250	266013	PN2-4-250-BT	118882	

1230PIC-672 Symbolphoto



400	630	PN3-4-400	266021	PN3-4-400-BT	111653	
630	630	PN3-4-630	266022	PN3-4-630-BT	111654	

# 1.10

## Compact circuit breakers, switch disconnectors

Switch disconnectors IEC, 4 pole  
PN...-4, N...-4

Rated current = Rated uninterrupted current	Short-circuit protection max. fuse gL-characteristic	<b>Fixed mounting with screw terminals</b> Part no.	Article no.
$I_n = I_u$ A	A gL		

### Switch disconnectors

- IEC/EN 60947-2

#### 3 switch positions I, +, 0

Can be remotely operated with shunt release XU/XA, remote operator XR  
Can be equipped with trip-indicating auxiliary contact M22-K..

1230PIC-751 Symbolphoto



63	125	N1-4-63	266002
100	125	N1-4-100	266003
125	125	N1-4-125	266004
160	160	N1-4-160	281254

1230PIC-797 Symbolphoto



160	250	N2-4-160	266014
200	250	N2-4-200	266015
250	250	N2-4-250	266016

1230PIC-672 Symbolphoto



400	630	N3-4-400	266023
	630	-	
630	630	N3-4-630	266024
	630	-	

1230PIC-673 Symbolphoto



800	1600	N4-4-800	266029
1000	1600	N4-4-1000	266030
1250	1600	N4-4-1250	266031
1600	1600	N4-4-1600	266032

# Compact circuit breakers, switch disconnectors

# 1.10

Switch disconnectors IEC, 4 pole  
PN...-4, N...-4

Fixed mounting with box terminals  
Part no.

Article no.

Plug-in/withdrawable units  
Part no.

Article no.

Std. pack

For further terminal types  
see accessories

Withdrawable units as accessory

\_\_\_\_\_  
\_\_\_\_\_  
\_\_\_\_\_

Withdrawable units as accessory

1 Off

\_\_\_\_\_  
\_\_\_\_\_  
\_\_\_\_\_

N2-4-160-BT	118883
N2-4-200-BT	118884
N2-4-250-BT	118885



N2-4-160-SVE	113736
N2-4-200-SVE	113737
N2-4-250-SVE	113738

N3-4-400-BT	111651
-	
N3-4-630-BT	111652
-	



N3-4-400-SVE	168470
N3-4-400-AVE	110872
N3-4-630-SVE	168471
N3-4-630-AVE	110873

\_\_\_\_\_  
\_\_\_\_\_  
\_\_\_\_\_

Withdrawable units as accessory

\_\_\_\_\_  
\_\_\_\_\_  
\_\_\_\_\_

# 2.1

## Compact circuit breakers, switch disconnectors

Circuit breakers UL/CSA, IEC, thermomagnetic releases, 3 pole  
NZM...A...NA

Switching capacity				Rated current = Rated uninterrupted current	Setting range		Fixed mounting Part no.	Article no.
SCCR 480Y/277 V 60 Hz	SCCR 480 V 60 Hz	SCCR 600Y/347 V 60 Hz	SCCR 600 V 60 Hz		Overload releases	Short-circuit releases Non-delayed		
$I_{cu}$ kA	$I_{cu}$ kA	$I_{cu}$ kA	$I_{cu}$ kA	$I_n = I_u$ A	$I_r$ A	$I_s = I_r \times \dots$		

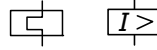

### System and cable protection

Fixed overload releases  $I_r$

#### Basic switching capacity

1230PIC-785 Symbolphoto



25	-	-	-	20	15 - 20	350 A fixed	Screw terminals as accessories	
				25	20 - 25	350 A fixed		
				32	25 - 32	350 A fixed		
				40	32 - 40	8 - 10		
				50	40 - 50	6 - 10		
				63	50 - 63	6 - 10		
				80	63 - 80	6 - 10		
				100	80 - 100	6 - 10		
			125	100 - 125	6 - 10			

1230PIC-802 Symbolphoto



25	25	18	-	20	15 - 20	350 A fixed	NZMB2-A20-NA	269206
				25	20 - 25	350 A fixed	NZMB2-A25-NA	269207
				32	25 - 32	350 A fixed	NZMB2-A32-NA	269208
				40	32 - 40	8 - 10	NZMB2-A40-NA	269209
				50	40 - 50	6 - 10	NZMB2-A50-NA	269210
				63	50 - 63	6 - 10	NZMB2-A63-NA	269211
				80	63 - 80	6 - 10	NZMB2-A80-NA	269212
				100	80 - 100	6 - 10	NZMB2-A100-NA	269213
				125	100 - 125	6 - 10	NZMB2-A125-NA	269214
				160	125 - 160	6 - 10	NZMB2-A160-NA	269215
				200	160 - 200	6 - 10	NZMB2-A200-NA	269216
				250	200 - 250	6 - 10	NZMB2-A250-NA	271105

#### Normal switching capacity

1230PIC-785 Symbolphoto



35	-	-	-	20	15 - 20	350 A fixed	Screw terminals as accessories	
				25	20 - 25	350 A fixed		
				32	25 - 32	350 A fixed		
				40	32 - 40	8 - 10		
				50	40 - 50	6 - 10		
				63	50 - 63	6 - 10		
				80	63 - 80	6 - 10		
				100	80 - 100	6 - 10		
			125	100 - 125	6 - 10			

1230PIC-802 Symbolphoto



35	35	25	-	20	15 - 20	350 A fixed	NZMN2-A20-NA	269217
				25	20 - 25	350 A fixed	NZMN2-A25-NA	269218
				32	25 - 32	350 A fixed	NZMN2-A32-NA	269219
				40	32 - 40	8 - 10	NZMN2-A40-NA	269220
				50	40 - 50	6 - 10	NZMN2-A50-NA	269221
				63	50 - 63	6 - 10	NZMN2-A63-NA	269222
				80	63 - 80	6 - 10	NZMN2-A80-NA	269223
				100	80 - 100	6 - 10	NZMN2-A100-NA	269224
				125	100 - 125	6 - 10	NZMN2-A125-NA	269225
				160	125 - 160	6 - 10	NZMN2-A160-NA	269226
				200	160 - 200	6 - 10	NZMN2-A200-NA	269227
				250	200 - 250	6 - 10	NZMN2-A250-NA	271106

# Compact circuit breakers, switch disconnectors

Circuit breakers UL/CSA, IEC, thermomagnetic releases, 3 pole  
NZM...A...NA

# 2.1

## Fixed mounting with box terminals







Part no.

Article no.

Std. pack

Information relevant for export to North America





NZMB1-A20-NA	281559	1 Off		Product Standards	UL 489; CSA-C22.2 No. 5-09; IEC 60947-2; CE marking
NZMB1-A25-NA	281560		 	UL File No.	E31593
NZMB1-A32-NA	281561			UL Category Control No.	DIVQ
NZMB1-A40-NA	272253			CSA File No.	022086
NZMB1-A50-NA	272254			CSA Class No.	1432-01
NZMB1-A63-NA	272255			North America Certification	UL listed, CSA certified
NZMB1-A80-NA	272256			Specially designed for NA	Yes
NZMB1-A100-NA	272258			Suitable for	Feeder circuits, branch circuits
NZMB1-A125-NA	281562			Current Limiting Circuit breaker	Yes
				Max. Voltage Rating	480Y/277 V
				Degree of Protection	IEC: IP20; UL/CSA Type: -
NZMB2-A20-BT-NA	107773	1 Off		Product Standards	UL 489; CSA-C22.2 No. 5-09; IEC 60947-2; CE marking
NZMB2-A25-BT-NA	107774		 	UL File No.	E31593
NZMB2-A32-BT-NA	107775			UL Category Control No.	DIVQ
NZMB2-A40-BT-NA	107776			CSA File No.	022086
NZMB2-A50-BT-NA	107777			CSA Class No.	1432-01
NZMB2-A63-BT-NA	107778			North America Certification	UL listed, CSA certified
NZMB2-A80-BT-NA	107779			Specially designed for NA	Yes
NZMB2-A100-BT-NA	107780			Suitable for	Feeder circuits, branch circuits
NZMB2-A125-BT-NA	107781			Current Limiting Circuit breaker	Yes
NZMB2-A160-BT-NA	107782			Max. Voltage Rating	600Y/347 V, 480 V
NZMB2-A200-BT-NA	107783			Degree of Protection	IEC: IP20; UL/CSA Type: -
NZMB2-A250-BT-NA	107784				
NZMN1-A20-NA	281570	1 Off		Product Standards	UL 489; CSA-C22.2 No. 5-09; IEC 60947-2; CE marking
NZMN1-A25-NA	281571		 	UL File No.	E31593
NZMN1-A32-NA	281572			UL Category Control No.	DIVQ
NZMN1-A40-NA	274237			CSA File No.	022086
NZMN1-A50-NA	274239			CSA Class No.	1432-01
NZMN1-A63-NA	274240			North America Certification	UL listed, CSA certified
NZMN1-A80-NA	274241			Specially designed for NA	Yes
NZMN1-A100-NA	274242			Suitable for	Feeder circuits, branch circuits
NZMN1-A125-NA	281573			Current Limiting Circuit breaker	Yes
				Max. Voltage Rating	480Y/277 V
				Degree of Protection	IEC: IP20; UL/CSA Type: -
NZMN2-A20-BT-NA	107785	1 Off		Product Standards	UL 489; CSA-C22.2 No. 5-09; IEC 60947-2; CE marking
NZMN2-A25-BT-NA	107786		 	UL File No.	E31593
NZMN2-A32-BT-NA	107787			UL Category Control No.	DIVQ
NZMN2-A40-BT-NA	107788			CSA File No.	022086
NZMN2-A50-BT-NA	107789			CSA Class No.	1432-01
NZMN2-A63-BT-NA	107790			North America Certification	UL listed, CSA certified
NZMN2-A80-BT-NA	107791			Specially designed for NA	Yes
NZMN2-A100-BT-NA	107792			Suitable for	Feeder circuits, branch circuits
NZMN2-A125-BT-NA	107793			Current Limiting Circuit breaker	Yes
NZMN2-A160-BT-NA	107794			Max. Voltage Rating	600Y/347 V, 480 V
NZMN2-A200-BT-NA	107795			Degree of Protection	IEC: IP20; UL/CSA Type: -
NZMN2-A250-BT-NA	107796				

# 2.1

## Compact circuit breakers, switch disconnectors

Circuit breakers UL/CSA, IEC, thermomagnetic releases, 3 pole  
NZM...A...NA

Switching capacity				Rated current = Rated uninterrupted current	Setting range		Fixed mounting Part no.	Article no.
SCCR 480Y/277 V 60 Hz	SCCR 480 V 60 Hz	SCCR 600Y/347 V 60 Hz	SCCR 600 V 60 Hz		Overload releases	Short-circuit releases Non-delayed		
$I_{cu}$ kA	$I_{cu}$ kA	$I_{cu}$ kA	$I_{cu}$ kA	$I_n = I_u$ A	$I_r$ A	$I_s = I_p \times \dots$		
								

### System and cable protection

Fixed overload releases  $I_r$

#### High switching capacity

1230PIC-802 Symbolphoto



150	150	65	-	20	15 - 20	350 A fixed	NZMH2-A20-NA	269228
				25	20 - 25	350 A fixed	NZMH2-A25-NA	269229
				32	25 - 32	350 A fixed	NZMH2-A32-NA	269230
				40	32 - 40	8 - 10	NZMH2-A40-NA	269231
				50	40 - 50	6 - 10	NZMH2-A50-NA	269232
				63	50 - 63	6 - 10	NZMH2-A63-NA	269233
				80	63 - 80	6 - 10	NZMH2-A80-NA	269234
				100	80 - 100	6 - 10	NZMH2-A100-NA	269235
				125	100 - 125	6 - 10	NZMH2-A125-NA	269236
				100	100	50	-	160
200	160 - 200	6 - 10	NZMH2-A200-NA					269238
250	200 - 250	6 - 10	NZMH2-A250-NA					271107

# Compact circuit breakers, switch disconnectors

# 2.1

Circuit breakers UL/CSA, IEC, thermomagnetic releases, 3 pole  
NZM...A...NA

## Fixed mounting with box terminals

Part no.

Article no.

Std. pack

Information relevant for export to North America



Part no.	Article no.	Std. pack	Information relevant for export to North America
NZMH2-A20-BT-NA	107797	1 Off	Product Standards UL 489; CSA-C22.2 No. 5-09; IEC 60947-2; CE marking
NZMH2-A25-BT-NA	107798		UL File No. E31593
NZMH2-A32-BT-NA	107799		UL Category Control No. DIVQ
NZMH2-A40-BT-NA	107800		CSA File No. 022086
NZMH2-A50-BT-NA	107801		CSA Class No. 1432-01
NZMH2-A63-BT-NA	107802		North America Certification UL listed, CSA certified
NZMH2-A80-BT-NA	107803		Specially designed for NA Yes
NZMH2-A100-BT-NA	107804		Suitable for Feeder circuits, branch circuits
NZMH2-A125-BT-NA	107805		Current Limiting Circuit breaker Yes
NZMH2-A160-BT-NA	107806		Max. Voltage Rating 600Y/347 V, 480 V
NZMH2-A200-BT-NA	107807		Degree of Protection IEC: IP20; UL/CSA Type: -
NZMH2-A250-BT-NA	107808		

# 2.1

## Compact circuit breakers, switch disconnectors

Circuit breakers UL/CSA, IEC, thermomagnetic releases, 3 pole  
NZM...AF...NA

Switching capacity				Rated current = Rated uninterrupted current	Setting range		Fixed mounting Part no.	Article no.
SCCR 480Y/277 V 60 Hz	SCCR 480 V 60 Hz	SCCR 600Y/347 V 60 Hz	SCCR 600 V 60 Hz		Overload releases	Short-circuit releases Non-delayed		
$I_{cu}$ kA	$I_{cu}$ kA	$I_{cu}$ kA	$I_{cu}$ kA	$I_n = I_u$ A	$I_r$ A	$I_s = I_n \times \dots$		

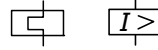

### System and cable protection

Fixed overload releases  $I_r$

#### Basic switching capacity

sg04515 Symbolphoto



25	-	-	-	20	20 A fixed	350 A fixed	Screw terminals as accessories		
				25	25 A fixed	350 A fixed			
				30	30 A fixed	350 A fixed			
				35	35 A fixed	8 - 10			
				40	40 A fixed	8 - 10			
				45	45 A fixed	6 - 10			
				50	50 A fixed	6 - 10			
				60	60 A fixed	6 - 10			
				70	70 A fixed	6 - 10			
				80	80 A fixed	6 - 10			
				90	90 A fixed	6 - 10			
				100	100 A fixed	6 - 10			
				110	110 A fixed	6 - 10			
				125	125 A fixed	6 - 10			

sg04215 Symbolphoto



25	25	18	-	15	15 A fixed	350 A fixed	NZMB2-AF15-NA	269142
				20	20 A fixed	350 A fixed	NZMB2-AF20-NA	269143
				25	25 A fixed	350 A fixed	NZMB2-AF25-NA	269144
				30	30 A fixed	350 A fixed	NZMB2-AF30-NA	269145
				35	35 A fixed	8 - 10	NZMB2-AF35-NA	269146
				40	40 A fixed	8 - 10	NZMB2-AF40-NA	269147
				45	45 A fixed	6 - 10	NZMB2-AF45-NA	269148
				50	50 A fixed	6 - 10	NZMB2-AF50-NA	269149
				60	60 A fixed	6 - 10	NZMB2-AF60-NA	269160
				70	70 A fixed	6 - 10	NZMB2-AF70-NA	269161
				80	80 A fixed	6 - 10	NZMB2-AF80-NA	269162
				90	90 A fixed	6 - 10	NZMB2-AF90-NA	269163
				100	100 A fixed	6 - 10	NZMB2-AF100-NA	269164
				110	110 A fixed	6 - 10	NZMB2-AF110-NA	269165
				125	125 A fixed	6 - 10	NZMB2-AF125-NA	269166
				150	150 A fixed	6 - 10	NZMB2-AF150-NA	269167
				175	175 A fixed	6 - 10	NZMB2-AF175-NA	269168
				200	200 A fixed	6 - 10	NZMB2-AF200-NA	269169
				225	225 A fixed	6 - 10	NZMB2-AF225-NA	271089
				250	250 A fixed	6 - 10	NZMB2-AF250-NA	271100



# Compact circuit breakers, switch disconnectors

# 2.1

Circuit breakers UL/CSA, IEC, thermomagnetic releases, 3 pole  
NZM...AF...NA

## Fixed mounting with box terminals

Part no.

Article no.

Std. pack

Information relevant for export to North America



Part no.	Article no.	Std. pack	Information relevant for export to North America
NZMB1-AF20-NA	281554	1 Off	Product Standards UL 489; CSA-C22.2 No. 5-09; IEC 60947-2; CE marking
NZMB1-AF25-NA	281555		UL File No. E31593
NZMB1-AF30-NA	281556		UL Category Control No. DIVQ
NZMB1-AF35-NA	272204		CSA File No. 022086
NZMB1-AF40-NA	272205		CSA Class No. 1432-01
NZMB1-AF45-NA	272206		North America Certification UL listed, CSA certified
NZMB1-AF50-NA	272207		Specially designed for NA Yes
NZMB1-AF60-NA	272208		Suitable for Feeder circuits, branch circuits
NZMB1-AF70-NA	272209		Current Limiting Circuit breaker Yes
NZMB1-AF80-NA	272250		Max. Voltage Rating 480Y/277 V
NZMB1-AF90-NA	272251		Degree of Protection IEC: IP20; UL/CSA Type: -
NZMB1-AF100-NA	272252		
NZMB1-AF110-NA	281557		
NZMB1-AF125-NA	281558		
NZMB2-AF15-BT-NA	107611	1 Off	Product Standards UL 489; CSA-C22.2 No. 5-09; IEC 60947-2; CE marking
NZMB2-AF20-BT-NA	107612		UL File No. E31593
NZMB2-AF25-BT-NA	107613		UL Category Control No. DIVQ
NZMB2-AF30-BT-NA	107614		CSA File No. 022086
NZMB2-AF35-BT-NA	107615		CSA Class No. 1432-01
NZMB2-AF40-BT-NA	107616		North America Certification UL listed, CSA certified
NZMB2-AF45-BT-NA	107617		Specially designed for NA Yes
NZMB2-AF50-BT-NA	107618		Suitable for Feeder circuits, branch circuits
NZMB2-AF60-BT-NA	107619		Current Limiting Circuit breaker Yes
NZMB2-AF70-BT-NA	107620		Max. Voltage Rating 600Y/347 V, 480 V
NZMB2-AF80-BT-NA	107621		Degree of Protection IEC: IP20; UL/CSA Type: -
NZMB2-AF90-BT-NA	107622		
NZMB2-AF100-BT-NA	107623		
NZMB2-AF110-BT-NA	107624		
NZMB2-AF125-BT-NA	107625		
NZMB2-AF150-BT-NA	107626		
NZMB2-AF175-BT-NA	107627		
NZMB2-AF200-BT-NA	107628		
NZMB2-AF225-BT-NA	107629		
NZMB2-AF250-BT-NA	107630		

# 2.1

## Compact circuit breakers, switch disconnectors

Circuit breakers UL/CSA, IEC, thermomagnetic releases, 3 pole  
NZM...AF...NA

Switching capacity				Rated current = Rated uninterrupted current	Setting range		Fixed mounting Part no.	Article no.
SCCR 480Y/277 V 60 Hz	SCCR 480 V 60 Hz	SCCR 600Y/347 V 60 Hz	SCCR 600 V 60 Hz		Overload releases	Short-circuit releases Non-delayed		
$I_{cu}$ kA	$I_{cu}$ kA	$I_{cu}$ kA	$I_{cu}$ kA	$I_n = I_u$ A	$I_r$ A	$I_s = I_n \times \dots$		

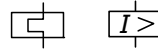

### System and cable protection

Fixed overload releases  $I_r$

#### Normal switching capacity

sg04515 Symbolphoto



35	-	-	-	20	20 A fixed	350 A fixed	Screw terminals as accessories		
				25	25 A fixed	350 A fixed			
				30	30 A fixed	350 A fixed			
				35	35 A fixed	8 - 10			
				40	40 A fixed	8 - 10			
				45	45 A fixed	6 - 10			
				50	50 A fixed	6 - 10			
				60	60 A fixed	6 - 10			
				70	70 A fixed	6 - 10			
				80	80 A fixed	6 - 10			
				90	90 A fixed	6 - 10			
				100	100 A fixed	6 - 10			
				110	110 A fixed	6 - 10			
				125	125 A fixed	6 - 10			

sg04215 Symbolphoto



35	35	25	-	15	15 A fixed	350 A fixed	NZMN2-AF15-NA	269170
				20	20 A fixed	350 A fixed	NZMN2-AF20-NA	269171
				25	25 A fixed	350 A fixed	NZMN2-AF25-NA	269172
				30	30 A fixed	350 A fixed	NZMN2-AF30-NA	269173
				35	35 A fixed	8 - 10	NZMN2-AF35-NA	269174
				40	40 A fixed	8 - 10	NZMN2-AF40-NA	269175
				45	45 A fixed	6 - 10	NZMN2-AF45-NA	269176
				50	50 A fixed	6 - 10	NZMN2-AF50-NA	269177
				60	60 A fixed	6 - 10	NZMN2-AF60-NA	269178
				70	70 A fixed	6 - 10	NZMN2-AF70-NA	269179
				80	80 A fixed	6 - 10	NZMN2-AF80-NA	269180
				90	90 A fixed	6 - 10	NZMN2-AF90-NA	269181
				100	100 A fixed	6 - 10	NZMN2-AF100-NA	269182
				110	110 A fixed	6 - 10	NZMN2-AF110-NA	269183
				125	125 A fixed	6 - 10	NZMN2-AF125-NA	269184
				150	150 A fixed	6 - 10	NZMN2-AF150-NA	269185
				175	175 A fixed	6 - 10	NZMN2-AF175-NA	269186
				200	200 A fixed	6 - 10	NZMN2-AF200-NA	269187
				225	225 A fixed	6 - 10	NZMN2-AF225-NA	271101
				250	250 A fixed	6 - 10	NZMN2-AF250-NA	271102

# Compact circuit breakers, switch disconnectors

Circuit breakers UL/CSA, IEC, thermomagnetic releases, 3 pole  
NZM...AF...NA

# 2.1

## Fixed mounting with box terminals

Part no. Article no. Std. pack Information relevant for export to North America



Part no.	Article no.	Std. pack	Information relevant for export to North America
NZMN1-AF20-NA	281565	1 Off	Product Standards UL 489; CSA-C22.2 No. 5-09; IEC 60947-2; CE marking
NZMN1-AF25-NA	281566		UL File No. E31593
NZMN1-AF30-NA	281567		UL Category Control No. DIVQ
NZMN1-AF35-NA	274220		CSA File No. 022086
NZMN1-AF40-NA	274223		CSA Class No. 1432-01
NZMN1-AF45-NA	274230		North America Certification UL listed, CSA certified
NZMN1-AF50-NA	274231		Specially designed for NA Yes
NZMN1-AF60-NA	274232		Suitable for Feeder circuits, branch circuits
NZMN1-AF70-NA	274233		Current Limiting Circuit breaker Yes
NZMN1-AF80-NA	274234		Max. Voltage Rating 480Y/277 V
NZMN1-AF90-NA	274235		Degree of Protection IEC: IP20; UL/CSA Type: -
NZMN1-AF100-NA	274236		
NZMN1-AF110-NA	281568		
NZMN1-AF125-NA	281569		
NZMN2-AF15-BT-NA	107631	1 Off	Product Standards UL 489; CSA-C22.2 No. 5-09; IEC 60947-2; CE marking
NZMN2-AF20-BT-NA	107632		UL File No. E31593
NZMN2-AF25-BT-NA	107633		UL Category Control No. DIVQ
NZMN2-AF30-BT-NA	107634		CSA File No. 022086
NZMN2-AF35-BT-NA	107635		CSA Class No. 1432-01
NZMN2-AF40-BT-NA	107636		North America Certification UL listed, CSA certified
NZMN2-AF45-BT-NA	107637		Specially designed for NA Yes
NZMN2-AF50-BT-NA	107638		Suitable for Feeder circuits, branch circuits
NZMN2-AF60-BT-NA	107639		Current Limiting Circuit breaker Yes
NZMN2-AF70-BT-NA	107640		Max. Voltage Rating 600Y/347 V, 480 V
NZMN2-AF80-BT-NA	107641		Degree of Protection IEC: IP20; UL/CSA Type: -
NZMN2-AF90-BT-NA	107642		
NZMN2-AF100-BT-NA	107643		
NZMN2-AF110-BT-NA	107644		
NZMN2-AF125-BT-NA	107645		
NZMN2-AF150-BT-NA	107646		
NZMN2-AF175-BT-NA	107647		
NZMN2-AF200-BT-NA	107648		
NZMN2-AF225-BT-NA	107649		
NZMN2-AF250-BT-NA	107650		

# 2.1

## Compact circuit breakers, switch disconnectors

Circuit breakers UL/CSA, IEC, thermomagnetic releases, 3 pole  
NZM...AF...NA

Switching capacity				Rated current = Rated uninterrupted current	Setting range		Fixed mounting Part no.	Article no.
SCCR 480Y/277 V 60 Hz	SCCR 480 V 60 Hz	SCCR 600Y/347 V 60 Hz	SCCR 600 V 60 Hz		Overload releases	Short-circuit releases Non-delayed		
$I_{cu}$ kA	$I_{cu}$ kA	$I_{cu}$ kA	$I_{cu}$ kA	$I_n = I_u$ A	$I_r$ A	$I_s = I_r \times \dots$		

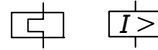

### System and cable protection

Fixed overload releases  $I_r$

#### High switching capacity

sg04215 Symbolphoto



$I_{cu}$ (kA)	$I_{cu}$ (kA)	$I_{cu}$ (kA)	$I_{cu}$ (kA)	$I_n$ (A)	Overload releases	Short-circuit releases	Part no.	Article no.
150	150	65	-	15	15 A fixed	350 A fixed	NZMH2-AF15-NA	269188
				20	20 A fixed	350 A fixed	NZMH2-AF20-NA	269189
				25	25 A fixed	350 A fixed	NZMH2-AF25-NA	269190
				30	30 A fixed	350 A fixed	NZMH2-AF30-NA	269191
				35	35 A fixed	8 - 10	NZMH2-AF35-NA	269192
				40	40 A fixed	8 - 10	NZMH2-AF40-NA	269193
				45	45 A fixed	6 - 10	NZMH2-AF45-NA	269194
				50	50 A fixed	6 - 10	NZMH2-AF50-NA	269195
				60	60 A fixed	6 - 10	NZMH2-AF60-NA	269196
				70	70 A fixed	6 - 10	NZMH2-AF70-NA	269197
				80	80 A fixed	6 - 10	NZMH2-AF80-NA	269198
				90	90 A fixed	6 - 10	NZMH2-AF90-NA	269199
				100	100 A fixed	6 - 10	NZMH2-AF100-NA	269200
				110	110 A fixed	6 - 10	NZMH2-AF110-NA	269201
				125	125 A fixed	6 - 10	NZMH2-AF125-NA	269202
100	100	50	-	150	150 A fixed	6 - 10	NZMH2-AF150-NA	269203
				175	175 A fixed	6 - 10	NZMH2-AF175-NA	269204
				200	200 A fixed	6 - 10	NZMH2-AF200-NA	269205
				225	225 A fixed	6 - 10	NZMH2-AF225-NA	271103
				250	250 A fixed	6 - 10	NZMH2-AF250-NA	271104

# Compact circuit breakers, switch disconnectors

# 2.1

Circuit breakers UL/CSA, IEC, thermomagnetic releases, 3 pole  
NZM...AF...NA

## Fixed mounting with box terminals

Part no.

Article no.

Std. pack

Information relevant for export to North America



Part no.	Article no.	Std. pack	Information relevant for export to North America
NZMH2-AF15-BT-NA	107809	1 Off	Product Standards
NZMH2-AF20-BT-NA	107810		UL 489; CSA-C22.2 No. 5-09; IEC 60947-2; CE marking
NZMH2-AF25-BT-NA	107811		UL File No.
NZMH2-AF30-BT-NA	107812		E31593
NZMH2-AF35-BT-NA	107813		UL Category Control No.
NZMH2-AF40-BT-NA	107814		DIVQ
NZMH2-AF45-BT-NA	107815		CSA File No.
NZMH2-AF50-BT-NA	107816		022086
NZMH2-AF60-BT-NA	107817		CSA Class No.
NZMH2-AF70-BT-NA	107818		1432-01
NZMH2-AF80-BT-NA	107819		North America Certification
NZMH2-AF90-BT-NA	107820		UL listed, CSA certified
NZMH2-AF100-BT-NA	107821		Specially designed for NA
NZMH2-AF110-BT-NA	107822		Yes
NZMH2-AF125-BT-NA	107823		Suitable for
NZMH2-AF150-BT-NA	107824		Feeder circuits, branch circuits
NZMH2-AF175-BT-NA	107825		Current Limiting Circuit breaker
NZMH2-AF200-BT-NA	107826		Yes
NZMH2-AF225-BT-NA	107827		Max. Voltage Rating
NZMH2-AF250-BT-NA	107828		600Y/347 V, 480 V
			Degree of Protection
			IEC: IP20; UL/CSA Type: -

# 2.2

## Compact circuit breakers, switch disconnectors

Circuit breakers UL/CSA, IEC, magnetic short-circuit releases, 3 pole  
 NZM...-S...CNA

Rated current =  
 Rated uninterrupted current  
 $I_n = I_u$   
 A

Setting range short-circuit release  
 Non-delayed  
 $I_i = I_n \times \dots$



Fixed mounting with screw terminals  
 Part no.

Article no.

### Short-circuit protection

Motor protection in conjunction with contactor and overload relay

- with short-circuit release
- without overload release  $I_r$

### Basic switching capacity

1230PIC-787 Symbolphoto



1,2	7 - 12	Screw terminals	
2	6 - 11	as accessories	
3	6 - 11		
5	6 - 11		
8	6 - 11		
12	7 - 12		
18	7 - 12		
26	8 - 13		
33	8 - 14		
40	8 - 14		
50	8 - 14		
63	8 - 14		
80	8 - 14		
100	8 - 13		

1230PIC-804 Symbolphoto



1,6	8 - 14	NZMB2-S1,6-CNA	269472
2,4	8 - 14	NZMB2-S2,4-CNA	269473
5	6 - 11	NZMB2-S5-CNA	103034
8	6 - 11	NZMB2-S8-CNA	103035
12	7 - 12	NZMB2-S12-CNA	103036
18	7 - 12	NZMB2-S18-CNA	103037
26	8 - 13	NZMB2-S26-CNA	103038
33	8 - 14	NZMB2-S33-CNA	103039
40	8 - 14	NZMB2-S40-CNA	269243
50	8 - 14	NZMB2-S50-CNA	269244
63	8 - 14	NZMB2-S63-CNA	269245
80	8 - 14	NZMB2-S80-CNA	269246
100	8 - 14	NZMB2-S100-CNA	269247
125	8 - 14	NZMB2-S125-CNA	269248
160	8 - 14	NZMB2-S160-CNA	269249
200	8 - 13	NZMB2-S200-CNA	269250
250	8 - 10	NZMB2-S250-CNA	102478

# Compact circuit breakers, switch disconnectors

Circuit breakers UL/CSA, IEC, magnetic short-circuit releases, 3 pole  
NZM...-S...CNA

# 2.2

## Fixed mounting with box terminals

Part no.

Article no.

Std. pack

Information relevant for export to North America



For further terminal types  
see accessories

NZMB1-S1,2-CNA	102906	1 Off	Product Standards	UL 489; CSA-C22.2 No. 5-09
NZMB1-S2-CNA	102907		UL File No.	E31593
NZMB1-S3-CNA	102908		UL Category Control No.	DKPU2
NZMB1-S5-CNA	102909		CSA File No.	022086
NZMB1-S8-CNA	103020		CSA Class No.	1432-01
NZMB1-S12-CNA	103021		North America Certification	UL recognized, CSA certified
NZMB1-S18-CNA	103022		Conditions of Acceptability	Only used in motor circuits in conjunction with suitable contactor and overload relay. SCCR value applies for complete combination starter only, consisting of instantaneous trip circuit breaker, contactor and overload relay.
NZMB1-S26-CNA	103023		Specially designed for NA	Yes
NZMB1-S33-CNA	103024		Suitable for	Branch circuits, feeder circuits
NZMB1-S40-CNA	281263		Current Limiting Circuit breaker	No
NZMB1-S50-CNA	281264		Max. Voltage Rating	480Y/277 V
NZMB1-S63-CNA	281265		Degree of Protection	UL/CSA Type: -
NZMB1-S80-CNA	281266			
NZMB1-S100-CNA	281267			
NZMB2-S1,6-BT-CNA	107651	1 Off	Product Standards	UL 489; CSA-C22.2 No. 5-09
NZMB2-S2,4-BT-CNA	107652		UL File No.	E31593
NZMB2-S5-BT-CNA	107653		UL Category Control No.	DKPU2
NZMB2-S8-BT-CNA	107654		CSA File No.	022086
NZMB2-S12-BT-CNA	107655		CSA Class No.	1432-01
NZMB2-S18-BT-CNA	107656		North America Certification	UL recognized, CSA certified
NZMB2-S26-BT-CNA	107657		Conditions of Acceptability	Only used in motor circuits in conjunction with suitable contactor and overload relay. SCCR value applies for complete combination starter only, consisting of instantaneous trip circuit breaker, contactor and overload relay.
NZMB2-S33-BT-CNA	107658		Specially designed for NA	Yes
NZMB2-S40-BT-CNA	107659		Suitable for	Branch circuits, feeder circuits
NZMB2-S50-BT-CNA	107660		Current Limiting Circuit breaker	No
NZMB2-S63-BT-CNA	107661		Max. Voltage Rating	600Y/347 V, 480 V
NZMB2-S80-BT-CNA	107662		Degree of Protection	UL/CSA Type: -
NZMB2-S100-BT-CNA	107663			
NZMB2-S125-BT-CNA	107664			
NZMB2-S160-BT-CNA	107665			
NZMB2-S200-BT-CNA	107666			
NZMB2-S250-BT-CNA	107667			

# 2.2

## Compact circuit breakers, switch disconnectors

Circuit breakers UL/CSA, IEC, magnetic short-circuit releases, 3 pole  
NZM...-S...CNA

Rated current = Rated uninterrupted current $I_n = I_u$ A	Setting range Short-circuit releases Non-delayed $I_r = I_n \times \dots$	Fixed mounting with screw terminals Part no.	Article no.	Std. pack
--	---	---	-------------	-----------



### Short-circuit protection

Motor protection in conjunction with contactor and overload relay

- With short-circuit releases
- Without overload releases  $I_r$

### Normal switching capacity

1230PIC-787 Symbolphoto



1,2	7 - 12	NZMN1-S1,2-CNA	103025	1 Off
2	6 - 11	NZMN1-S2-CNA	103026	
3	6 - 11	NZMN1-S3-CNA	103027	
5	6 - 11	NZMN1-S5-CNA	103028	
8	6 - 11	NZMN1-S8-CNA	103029	
12	7 - 12	NZMN1-S12-CNA	103030	
18	7 - 12	NZMN1-S18-CNA	103031	
26	8 - 13	NZMN1-S26-CNA	103032	
33	8 - 14	NZMN1-S33-CNA	103033	
40	8 - 14	NZMN1-S40-CNA	281276	
50	8 - 14	NZMN1-S50-CNA	281277	
63	8 - 14	NZMN1-S63-CNA	281278	
80	8 - 14	NZMN1-S80-CNA	281279	
100	8 - 13	NZMN1-S100-CNA	281280	

1230PIC-804 Symbolphoto



1,6	8 - 14	NZMN2-S1,6-CNA	269478	1 Off
2,4	8 - 14	NZMN2-S2,4-CNA	269479	
5	6 - 11	NZMN2-S5-CNA	103040	
8	6 - 11	NZMN2-S8-CNA	103041	
12	7 - 12	NZMN2-S12-CNA	103042	
18	7 - 12	NZMN2-S18-CNA	103043	
26	8 - 13	NZMN2-S26-CNA	103044	
33	8 - 14	NZMN2-S33-CNA	103045	
40	8 - 14	NZMN2-S40-CNA	269255	
50	8 - 14	NZMN2-S50-CNA	269256	
63	8 - 14	NZMN2-S63-CNA	269257	
80	8 - 14	NZMN2-S80-CNA	269258	
100	8 - 14	NZMN2-S100-CNA	269259	
125	8 - 14	NZMN2-S125-CNA	269260	
160	8 - 14	NZMN2-S160-CNA	269261	
200	8 - 13	NZMN2-S200-CNA	269262	
250	8 - 10	NZMN2-S250-CNA	102479	

### High switching capacity

1230PIC-804 Symbolphoto



1,6	8 - 14	NZMH2-S1,6-CNA	269482	1 Off
2,4	8 - 14	NZMH2-S2,4-CNA	269483	
5	6 - 11	NZMH2-S5-CNA	103046	
8	6 - 11	NZMH2-S8-CNA	103047	
12	7 - 12	NZMH2-S12-CNA	103048	
18	5 - 9	NZMH2-S18-CNA	103049	
26	8 - 13	NZMH2-S26-CNA	103050	
33	8 - 14	NZMH2-S33-CNA	103051	
40	8 - 14	NZMH2-S40-CNA	269267	
50	8 - 14	NZMH2-S50-CNA	269268	
63	8 - 14	NZMH2-S63-CNA	269269	
80	8 - 14	NZMH2-S80-CNA	269270	
100	8 - 14	NZMH2-S100-CNA	269271	
125	8 - 14	NZMH2-S125-CNA	269272	
200	8 - 13	NZMH2-S160-CNA	269273	
250	8 - 10	NZMH2-S200-CNA	269274	
160	8 - 14	NZMH2-S250-CNA	102490	



# Compact circuit breakers, switch disconnectors

Circuit breakers UL/CSA, IEC, magnetic short-circuit releases, 3 pole  
NZM...-S...CNA

# 2.2

Information relevant for export to North America



For further terminal types  
see accessories

Product Standards	UL 489; CSA-C22.2 No. 5-09
UL File No.	E31593
UL Category Control No.	DKPU2
CSA File No.	022086
CSA Class No.	1432-01
North America Certification	UL recognized, CSA certified
Conditions of Acceptability	Only used in motor circuits in conjunction with suitable contactor and overload relay. SCCR value applies for complete combination starter only, consisting of instantaneous trip circuit breaker, contactor and overload relay.
Specially designed for NA	Yes
Suitable for	Branch circuits, feeder circuits
Current Limiting Circuit breaker	No
Max. Voltage Rating	480Y/277 V
Degree of Protection	UL/CSA Type: -

Product Standards	UL 489; CSA-C22.2 No. 5-09
UL File No.	E31593
UL Category Control No.	DKPU2
CSA File No.	022086
CSA Class No.	1432-01
NA Certification	UL recognized, CSA certified
Conditions of Acceptability	Only used in motor circuits in conjunction with suitable contactor and overload relay. SCCR value applies for complete combination starter only, consisting of instantaneous trip circuit breaker, contactor and overload relay.
Specially designed for NA	Yes
Suitable for	Branch circuits, feeder circuits
Current Limiting Circuit breaker	No
Max. Voltage Rating	600Y/347 V, 480 V
Degree of Protection	UL/CSA Type: -

Product Standards	UL 489; CSA-C22.2 No. 5-09
UL File No.	E31593
UL Category Control No.	DKPU2
CSA File No.	022086
CSA Class No.	1432-01
NA Certification	UL recognized, CSA certified
Conditions of Acceptability	Only used in motor circuits in conjunction with suitable contactor and overload relay. SCCR value applies for complete combination starter only, consisting of instantaneous trip circuit breaker, contactor and overload relay.
Specially designed for NA	Yes
Suitable for	Branch circuits, feeder circuits
Current Limiting Circuit breaker	No
Max. Voltage Rating	600Y/347 V, 480 V
Degree of Protection	UL/CSA Type: -

# 2.3

## Compact circuit breakers, switch disconnectors

Circuit breakers UL/CSA, IEC, electronic releases, 3 pole  
NZM...-AX...NA

Switching capacity				Rated current = Rated uninter- rupted current	Setting range		Fixed mounting with screw terminals		
SCCR 480Y/277 V 60 Hz	SCCR 480 V 60 Hz	SCCR 600Y/347 V 60 Hz	SCCR 600 V 60 Hz		Overload releases	Short-circuit releases Non-delayed	Part no.	Article no.	Std. pack
$I_{cu}$ kA	$I_{cu}$ kA	$I_{cu}$ kA	$I_{cu}$ kA	$I_n = I_u$ A	$I_r$ A	$I_r = I_n \times \dots$			

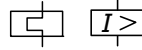

### System and cable protection

Adjustable overload release  $I_r$   
R.m.s. value measurement and "thermal memory"

#### Normal switching capacity

wa\_ren\_00418\_r Symbolphoto



35	35	25	-	40	20 - 40	2 - 12	NZMN2-AX40-NA	195224	1 Off
				100	40 - 100	2 - 12	NZMN2-AX100-NA	195225	
				160	64 - 160	2 - 12	NZMN2-AX160-NA	195226	
				250	100 - 250	2 - 12	NZMN2-AX250-NA	195227	

sg04015 Symbolphoto



42	42	35	35	250	100 - 250	2 - 11	NZMN3-AX250-NA	192484	1 Off
				400	160 - 400	2 - 11	NZMN3-AX400-NA	192485	
				600	240 - 600	2 - 8	NZMN3-AX600-NA	192486	

sg04715 Symbolphoto



42	42	35	35	800	320 - 800	2 - 12	NZMN4-AX800-NA	192542	1 Off
				1000	400 - 1000	2 - 12	NZMN4-AX1000-NA	192543	
				1200	480 - 1200	2 - 12	NZMN4-AX1200-NA	192544	

# Compact circuit breakers, switch disconnectors

Circuit breakers UL/CSA, IEC, electronic releases, 3 pole  
NZM...-AX...NA

# 2.3

Information relevant for export to North America



For further terminal types  
see accessories

---

Product Standards	UL 489; CSA-C22.2 No. 5-09; IEC 60947-2; CE marking
UL File No.	E31593
UL Category Control No.	DIVQ
CSA File No.	022086
CSA Class No.	1432-01
North America Certification	UL listed, CSA certified
Specially designed for NA	Yes
Suitable for	Feeder circuits, branch circuits
Current Limiting Circuit breaker	Yes
Max. Voltage Rating	600Y/347 V, 480 V
Degree of Protection	IEC: IP20; UL/CSA Type: -

---

Product Standards	UL 489; CSA-C22.2 No. 5-09; IEC 60947-2; CE marking
UL File No.	E31593
UL Category Control No.	DIVQ
CSA File No.	022086
CSA Class No.	1432-01
North America Certification	UL listed, CSA certified
Specially designed for NA	Yes
Suitable for	Feeder circuits, branch circuits
Current Limiting Circuit breaker	Yes
Max. Voltage Rating	600 V
Degree of Protection	IEC: IP20; UL/CSA Type: -

# 2.3

## Compact circuit breakers, switch disconnectors

Circuit breakers UL/CSA, IEC, electronic releases, 3 pole  
 NZM...-AX...NA

Switching capacity				Rated current = Rated uninter- rupted current	Setting range		Fixed mounting with screw terminals		
SCCR 480Y/277 V 60 Hz	SCCR 480 V 60 Hz	SCCR 600Y/347 V 60 Hz	SCCR 600 V 60 Hz		Overload releases	Short-circuit releases Non-delayed	Part no.	Article no.	Std. pack
$I_{cu}$ kA	$I_{cu}$ kA	$I_{cu}$ kA	$I_{cu}$ kA	$I_n = I_u$ A	$I_r$ A	$I_r = I_n \times \dots$			

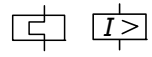

### System and cable protection

Adjustable overload release  $I_r$   
 R.m.s. value measurement and "thermal memory"

#### High switching capacity

wa\_ren\_00418\_r Symbolphoto



100	100	50	-	40	20 - 40	2 - 12	NZMH2-AX40-NA	195229	1 Off
				100	40 - 100	2 - 12	NZMH2-AX100-NA	195228	
				160	64 - 160	2 - 12	NZMH2-AX160-NA	195230	
				250	100 - 250	2 - 12	NZMH2-AX250-NA	195231	

sg04015 Symbolphoto



100	100	50	50	250	100 - 250	2 - 11	NZMH3-AX250-NA	192496	1 Off
				400	160 - 400	2 - 11	NZMH3-AX400-NA	192497	
				600	240 - 600	2 - 8	NZMH3-AX600-NA	192498	

sg04715 Symbolphoto



85	85	50	50	800	320 - 800	2 - 12	NZMH4-AX800-NA	192560	1 Off
				1000	400 - 1000	2 - 12	NZMH4-AX1000-NA	192561	
				1200	480 - 1200	2 - 12	NZMH4-AX1200-NA	192562	

# Compact circuit breakers, switch disconnectors

Circuit breakers UL/CSA, IEC, electronic releases, 3 pole  
NZM...-AX...NA

# 2.3

Information relevant for export to North America



For further terminal types  
see accessories

---

Product Standards	UL 489; CSA-C22.2 No. 5-09; IEC 60947-2; CE marking
UL File No.	E31593
UL Category Control No.	DIVQ
CSA File No.	022086
CSA Class No.	1432-01
North America Certification	UL listed, CSA certified
Specially designed for NA	Yes
Suitable for	Feeder circuits, branch circuits
Current Limiting Circuit breaker	Yes
Max. Voltage Rating	600Y/347 V, 480 V
Degree of Protection	IEC: IP20; UL/CSA Type: -



---

Product Standards	UL 489; CSA-C22.2 No. 5-09; IEC 60947-2; CE marking
UL File No.	E31593
UL Category Control No.	DIVQ
CSA File No.	022086
CSA Class No.	1432-01
North America Certification	UL listed, CSA certified
Specially designed for NA	Yes
Suitable for	Feeder circuits, branch circuits
Current Limiting Circuit breaker	Yes
Max. Voltage Rating	600 V
Degree of Protection	IEC: IP20; UL/CSA Type: -

# 2.3

## Compact circuit breakers, switch disconnectors

Circuit breakers UL/CSA, IEC, electronic releases, 3 pole  
 NZM...MX...NA

Switching capacity				Rated current = Rated uninterrupted current	Setting range		Fixed mounting Part no.	Article no.
SCCR 480Y/277 V 60 Hz	SCCR 480 V 60 Hz	SCCR 600Y/347 V 60 Hz	SCCR 600 V 60 Hz		Overload releases	Short-circuit releases Non-delayed		
$I_{cu}$ kA	$I_{cu}$ kA	$I_{cu}$ kA	$I_{cu}$ kA	$I_n = I_u$ A	$I_r$ A	$I_1 = I_n \times \dots$		
								

### Motor protection 100 % rated

Adjustable overload releases

For use in motor circuits with contactor.

Additional motor protective characteristics (calibration) to UL508, CSA-C22.2 No. 14-05.

### Normal switching capacity

1230PIC-854 Symbolphoto



35	35	-	-	90	36-90	2 - 14	NZMN2-MX90-NA	192523
				140	56-140	2 - 18	NZMN2-MX140-NA	192524
				200	80-200	2 - 15	NZMN2-MX200-NA	192439

### High switching capacity

1230PIC-854 Symbolphoto



100	100	-	-	90	36-90	2 - 14	NZMH2-MX90-NA	192462
				140	56-140	2 - 18	NZMH2-MX140-NA	192463
				200	80-200	2 - 15	NZMH2-MX200-NA	192464

wa\_ren\_01018\_r Symbolphoto



100	100	-	-	250	100 - 250	2 - 18	NZMH3-MX250-NA	193347
				350	140 - 350	2 - 15	NZMH3-MX350-NA	193348
				450	180 - 450	2 - 12	NZMH3-MX450-NA	193349

# Compact circuit breakers, switch disconnectors

# 2.3

Circuit breakers UL/CSA, IEC, electronic releases, 3 pole  
NZM...MX...NA

## Fixed mounting with box terminals

Part no.

Article no.

Std. pack

Information relevant for export to North America



Part no.	Article no.	Std. pack	Information relevant for export to North America
NZMN2-MX90-BT-NA	192440	1 Off	Product Standards UL File No. UL CCN CSA File No. CSA Class No. NA Certification Specially designed for NA Suitable for Current Limiting CB Max. Voltage Rating Degree of Protection
NZMN2-MX140-BT-NA	192441		UL 489; CSA-C22.2 No. 5-09; IEC 60947-2; CE marking E31593 DIVQ 022086 1432-01 UL Listed, CSA certified Yes, additionally calibrated according to UL 508 Feeder circuits, branch circuits Yes 480 V IEC: IP20; UL/CSA Type: -
NZMN2-MX200-BT-NA	192442		



NZMH2-MX90-BT-NA	192465	1 Off	Product Standards UL File No. UL CCN CSA File No. CSA Class No. NA Certification Specially designed for NA Suitable for Current Limiting CB Max. Voltage Rating Degree of Protection
NZMH2-MX140-BT-NA	192466		UL 489; CSA-C22.2 No. 5-09; IEC 60947-2; CE marking E31593 DIVQ 022086 1432-01 UL Listed, CSA certified Yes, additionally calibrated according to UL 508 Feeder circuits, branch circuits Yes 480 V IEC: IP20; UL/CSA Type: -
NZMH2-MX200-BT-NA	192467		

Terminals as accessory		1 Off	Product Standards UL File No. UL CCN CSA File No. CSA Class No. NA Certification Specially designed for NA Suitable for Current Limiting CB Max. Voltage Rating Degree of Protection
			UL 489; CSA-C22.2 No. 5-09; IEC 60947-2; CE marking E31593 DIVQ 022086 1432-01 UL Listed, CSA certified Yes, additionally calibrated according to UL 508 Feeder circuits, branch circuits Yes 600 V IEC: IP20; UL/CSA Type: -

# 2.3

## Compact circuit breakers, switch disconnectors

Circuit breakers UL/CSA, IEC, electronic releases, 3 pole  
 NZM...VX...NA

Switching capacity				Rated current = Rated uninterrupted current	Setting range		Fixed mounting Part no.	Article no.
SCCR 480Y/277 V 60 Hz	SCCR 480 V 60 Hz	SCCR 600Y/347 V 60 Hz	SCCR 600 V 60 Hz		Overload releases	Short-circuit releases Non-delayed		
$I_{cu}$ kA	$I_{cu}$ kA	$I_{cu}$ kA	$I_{cu}$ kA	$I_n = I_u$ A	$I_r$ A	$I_s = I_n \times \dots$		
								

### System and cable protection, selectivity and generator protection

Adjustable overload release  $I_r$   
 R.m.s. value measurement and "thermal memory"

#### Normal switching capacity

sg04315 Symbolphoto



35	35	25	-	100	40 - 100	2 - 18	NZMN2-VX100-NA	192448
				160	64 - 160	2 - 18	NZMN2-VX160-NA	192449
				250	100 - 250	2 - 12	NZMN2-VX250-NA	192450

1230PIC-711 Symbolphoto



42	42	35	35	250	100 - 250	2 - 18	NZMN3-VX250-NA	192502
				400	160 - 400	2 - 12	NZMN3-VX400-NA	192503
				600	240 - 600	2 - 8	NZMN3-VX600-NA	192504

1230PIC-715 Symbolphoto



42	42	35	35	800	320 - 800	2 - 18	NZMN4-VX800-NA	192551
				1000	400 - 1000	2 - 18	NZMN4-VX1000-NA	192552
				1200	480 - 1200	2 - 15	NZMN4-VX1200-NA	192553



# Compact circuit breakers, switch disconnectors

# 2.3

Circuit breakers UL/CSA, IEC, electronic releases, 3 pole  
NZM...VX...NA

## Fixed mounting with box terminals

Part no.

Article no.

Std. pack

Information relevant for export to North America



Part no.	Article no.	Std. pack	Information relevant for export to North America
NZMN2-VX100-BT-NA	192517	1 Off	Product Standards UL 489; CSA-C22.2 No. 5-09; IEC 60947-2; CE marking
NZMN2-VX160-BT-NA	192518		UL File No. E31593
NZMN2-VX250-BT-NA	192519		UL Category Control No. DIVQ
			CSA File No. 022086
			CSA Class No. 1432-01
			North America Certification UL listed, CSA certified
			Specially designed for NA Yes
			Suitable for Feeder circuits, branch circuits
			Current Limiting Circuit breaker Yes
			Max. Voltage Rating 600Y/347 V, 480 V
			Degree of Protection IEC: IP20; UL/CSA Type: -

Part no.	Article no.	Std. pack	Information relevant for export to North America
Terminals as accessory		1 Off	Product Standards UL 489; CSA-C22.2 No. 5-09; IEC 60947-2; CE marking
			UL File No. E31593
			UL Category Control No. DIVQ
			CSA File No. 022086
			CSA Class No. 1432-01
			North America Certification UL listed, CSA certified
			Specially designed for NA Yes
			Suitable for Feeder circuits, branch circuits
			Current Limiting Circuit breaker Yes
			Max. Voltage Rating 600 V
			Degree of Protection IEC: IP20; UL/CSA Type: -

Part no.	Article no.	Std. pack	Information relevant for export to North America
Terminals as accessory		1 Off	Product Standards UL 489; CSA-C22.2 No. 5-09; IEC 60947-2; CE marking
			UL File No. E31593
			UL Category Control No. DIVQ
			CSA File No. 022086
			CSA Class No. 1432-01
			North America Certification UL listed, CSA certified
			Specially designed for NA Yes
			Suitable for Feeder circuits, branch circuits
			Current Limiting Circuit breaker No
			Max. Voltage Rating 600 V
			Degree of Protection IEC: IP20; UL/CSA Type: -

# 2.3

## Compact circuit breakers, switch disconnectors

Circuit breakers UL/CSA, IEC, electronic releases, 3 pole  
 NZM...VX...NA

Switching capacity				Rated current = Rated uninterrupted current	Setting range		Fixed mounting Part no.	Article no.
SCCR 480Y/277 V 60 Hz	SCCR 480 V 60 Hz	SCCR 600Y/347 V 60 Hz	SCCR 600 V 60 Hz		Overload releases	Short-circuit releases Non-delayed		
$I_{cu}$ kA	$I_{cu}$ kA	$I_{cu}$ kA	$I_{cu}$ kA	$I_n = I_u$ A	$I_r$ A	$I_s = I_r \times \dots$		

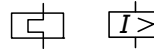

### System and cable protection

Fixed overload releases  $I_r$

#### High switching capacity

sg04315 Symbolphoto



100	100	50	-	100	40 - 100	2 - 18	NZMH2-VX100-NA	192473
				160	64 - 160	2 - 18	NZMH2-VX160-NA	192474
				250	100 - 250	2 - 12	NZMH2-VX250-NA	192475

t230PIC-711 Symbolphoto



100	100	50	50	250	100 - 250	2 - 18	NZMH3-VX250-NA	192533
				400	160 - 400	2 - 12	NZMH3-VX400-NA	192534
				600	240 - 600	2 - 8	NZMH3-VX600-NA	192535

t230PIC-715 Symbolphoto



85	85	50	50	800	320 - 800	2 - 18	NZMH4-VX800-NA	192569
				1000	400 - 1000	2 - 18	NZMH4-VX1000-NA	192570
				1200	480 - 1200	2 - 15	NZMH4-VX1200-NA	192571

# Compact circuit breakers, switch disconnectors

# 2.3

Circuit breakers UL/CSA, IEC, electronic releases, 3 pole  
NZM...VX...NA

## Fixed mounting with box terminals

Part no.

Article no.

Std. pack

Information relevant for export to North America



Part no.	Article no.	Std. pack	Information relevant for export to North America
NZMH2-VX100-BT-NA	192459	1 Off	Product Standards UL 489; CSA-C22.2 No. 5-09; IEC 60947-2; CE marking
NZMH2-VX160-BT-NA	192460		UL File No. E31593
NZMH2-VX250-BT-NA	192461		UL Category Control No. DIVQ
			CSA File No. 022086
			CSA Class No. 1432-01
			North America Certification UL listed, CSA certified
			Specially designed for NA Yes
			Suitable for Feeder circuits, branch circuits
			Current Limiting Circuit breaker Yes
			Max. Voltage Rating 600Y/347 V, 480 V
			Degree of Protection IEC: IP20; UL/CSA Type: -

Part no.	Article no.	Std. pack	Information relevant for export to North America
Terminals as accessory		1 Off	Product Standards UL 489; CSA-C22.2 No. 5-09; IEC 60947-2; CE marking
			UL File No. E31593
			UL Category Control No. DIVQ
			CSA File No. 022086
			CSA Class No. 1432-01
			North America Certification UL listed, CSA certified
			Specially designed for NA Yes
			Suitable for Feeder circuits, branch circuits
			Current Limiting Circuit breaker Yes
			Max. Voltage Rating 600 V
			Degree of Protection IEC: IP20; UL/CSA Type: -

Part no.	Article no.	Std. pack	Information relevant for export to North America
Terminals as accessory		1 Off	Product Standards UL 489; CSA-C22.2 No. 5-09; IEC 60947-2; CE marking
			UL File No. E31593
			UL Category Control No. DIVQ
			CSA File No. 022086
			CSA Class No. 1432-01
			North America Certification UL listed, CSA certified
			Specially designed for NA Yes
			Suitable for Feeder circuits, branch circuits
			Current Limiting Circuit breaker No
			Max. Voltage Rating 600 V
			Degree of Protection IEC: IP20; UL/CSA Type: -

# 2.4

## Compact circuit breakers, switch disconnectors

Circuit breakers UL/CSA, IEC, electronic releases with energy meter function, 3 pole  
NZM... PMX...NA

Switching capacity				Rated current = Rated uninter- rupted current	Setting range		Fixed mounting with screw terminals		
SCCR 480Y/277 V 60 Hz	SCCR 480 V 60 Hz	SCCR 600Y/347 V 60 Hz	SCCR 600 V 60 Hz		Overload releases	Short-circuit releases Non-delayed	Part no.	Article no.	Std. pack
$I_{cu}$ kA	$I_{cu}$ kA	$I_{cu}$ kA	$I_{cu}$ kA	$I_n = I_u$ A	$I_r$ A	$I_r = I_n \times \dots$			

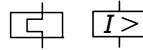

### Motor protection

Fixed overload releases  $I_r$

#### Normal switching capacity

wa\_ren\_00318\_r Symbolphoto



35	35	25	-	90	36 - 90	2 - 18	NZMN2-PMX90-NA	192580	1 Off
				140	56 - 140	2 - 18	NZMN2-PMX140-NA	192581	
				200	88 - 220	2 - 15	NZMN2-PMX220-NA	192582	

wa\_ren\_00818\_r Symbolphoto



42	42	35	35	250	100 - 250	2 - 18	NZMN3-PMX250-NA	193350	1 Off
				350	175 - 350	2 - 15	NZMN3-PMX350-NA	193351	
				450	225 - 450	2 - 12	NZMN3-PMX450-NA	193352	

#### High switching capacity

wa\_ren\_00318\_r Symbolphoto



100	100	50	-	90	36 - 90	2 - 18	NZMH2-PMX90-NA	192583	1 Off
				140	56 - 140	2 - 18	NZMH2-PMX140-NA	192584	
				200	88 - 220	2 - 15	NZMH2-PMX200-NA	192585	

wa\_ren\_00818\_r Symbolphoto



100	100	50	50	250	175 - 350	2 - 18	NZMH3-PMX250-NA	193353	1 Off
				350	175 - 350	2 - 15	NZMH3-PMX350-NA	193354	
				450	225 - 450	2 - 12	NZMH3-PMX450-NA	193355	

# Compact circuit breakers, switch disconnectors

# 2.4

Circuit breakers UL/CSA, IEC, electronic releases with energy meter function, 3 pole  
NZM... PMX...NA

Information relevant for export to North America



For further terminal types  
see accessories

---

Product Standards	UL 489; CSA-C22.2 No. 5-09; IEC 60947-2; CE marking
UL File No.	E31593
UL Category Control No.	DIVQ
CSA File No.	022086
CSA Class No.	1432-01
North America Certification	UL listed, CSA certified
Specially designed for NA	Yes, additionally calibrated according to UL 508
Suitable for	Feeder circuits, branch circuits
Current Limiting Circuit breaker	Yes
Max. Voltage Rating	480 V
Degree of Protection	IEC: IP20; UL/CSA Type: -

---

Product Standards	UL 489; CSA-C22.2 No. 5-09; IEC 60947-2; CE marking
UL File No.	E31593
UL Category Control No.	DIVQ
CSA File No.	022086
CSA Class No.	1432-01
North America Certification	UL listed, CSA certified
Specially designed for NA	Yes, additionally calibrated according to UL 508
Suitable for	Feeder circuits, branch circuits
Current Limiting Circuit breaker	Yes
Max. Voltage Rating	600 V
Degree of Protection	IEC: IP20; UL/CSA Type: -

---

Product Standards	UL 489; CSA-C22.2 No. 5-09; IEC 60947-2; CE marking
UL File No.	E31593
UL Category Control No.	DIVQ
CSA File No.	022086
CSA Class No.	1432-01
North America Certification	UL listed, CSA certified
Specially designed for NA	Yes, additionally calibrated according to UL 508
Suitable for	Feeder circuits, branch circuits
Current Limiting Circuit breaker	Yes
Max. Voltage Rating	480 V
Degree of Protection	IEC: IP20; UL/CSA Type: -

---

Product Standards	UL 489; CSA-C22.2 No. 5-09; IEC 60947-2; CE marking
UL File No.	E31593
UL Category Control No.	DIVQ
CSA File No.	022086
CSA Class No.	1432-01
North America Certification	UL listed, CSA certified
Specially designed for NA	Yes, additionally calibrated according to UL 508
Suitable for	Feeder circuits, branch circuits
Current Limiting Circuit breaker	Yes
Max. Voltage Rating	600 V
Degree of Protection	IEC: IP20; UL/CSA Type: -

# 2.4

## Compact circuit breakers, switch disconnectors

Circuit breakers UL/CSA, IEC, electronic releases with energy meter function, 3 pole  
NZM...PX...NA

Switching capacity				Rated current =	Setting range		Fixed mounting with screw terminals		
SCCR	SCCR	SCCR	SCCR	Rated	Overload	Short-circuit	Part no.	Article no.	Std. pack
480Y/277 V	480 V	600Y/347 V	600 V	uninterrupted	releases	releases			
60 Hz	60 Hz	60 Hz	60 Hz	current		Non-delayed			
$I_{cu}$	$I_{cu}$	$I_{cu}$	$I_{cu}$	$I_n = I_u$	$I_r$	$I_s = I_n \times \dots$			
kA	kA	kA	kA	A	A				

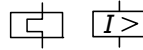

### System and cable protection

For further terminal types see accessories

Fixed overload releases  $I_r$

#### Normal switching capacity

wa\_ren\_00318\_r Symbolphoto



$I_{cu}$ (kA)	$I_{cu}$ (kA)	$I_{cu}$ (kA)	$I_{cu}$ (kA)	Rated current (A)	Overload releases	Short-circuit releases	Part no.	Article no.	Std. pack
35	35	25	-	40	20 - 40	2 - 18	NZMN2-PX40-NA	192572	1 Off
				100	40 - 100	2 - 18	NZMN2-PX100-NA	192573	
				160	64 - 160	2 - 18	NZMN2-PX160-NA	192574	
				250	100 - 250	2 - 12	NZMN2-PX250-NA	192575	

wa\_ren\_00318\_r Symbolphoto



42	42	35	35	250	100 - 250	2 - 18	NZMN3-PX250-NA	192586	1 Off
				400	160 - 400	2 - 12	NZMN3-PX400-NA	192587	
				600	240 - 600	2 - 8	NZMN3-PX600-NA	192588	

wa\_ren\_01818\_r Symbolphoto



42	42	35	35	800	320 - 800	2 - 18	NZMN4-PX800-NA	192592	1 Off
				1000	400 - 1000	2 - 18	NZMN4-PX1000-NA	192593	
				1200	480 - 1200	2 - 15	NZMN4-PX1200-NA	192594	

Product Standards	UL 489; CSA-C22.2 No. 5-09; IEC 60947-2; CE marking
UL File No.	E31593
UL Category Control No.	DIV0
CSA File No.	022086
CSA Class No.	1432-01
North America Certification	UL listed, CSA certified
Specially designed for NA	Yes
Suitable for	Feeder circuits, branch circuits
Current Limiting Circuit breaker	No
Max. Voltage Rating	600 V
Degree of Protection	IEC: IP20; UL/CSA Type: -

# Compact circuit breakers, switch disconnectors

# 2.4

Circuit breakers UL/CSA, IEC, electronic releases with energy meter function, 3 pole  
NZM...PX...NA

Switching capacity				Rated current = Rated uninter- rupted current	Setting range		Fixed mounting with screw terminals		
SCCR 480Y/277 V 60 Hz	SCCR 480 V 60 Hz	SCCR 600Y/347 V 60 Hz	SCCR 600 V 60 Hz		Overload releases	Short-circuit releases Non-delayed	Part no.	Article no.	Std. pack
$I_{cu}$ kA	$I_{cu}$ kA	$I_{cu}$ kA	$I_{cu}$ kA	$I_n = I_u$ A	$I_r$ A	$I_r = I_n \times \dots$			

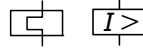

## System and cable protection

For further terminal types  
see accessories

Fixed overload releases  $I_r$

### High switching capacity

wa\_ren\_00318\_r Symbolphoto



$I_{cu}$ (kA)	$I_{cu}$ (kA)	$I_{cu}$ (kA)	$I_{cu}$ (kA)	Rated current (A)	Setting range (A)	Setting range (kA)	Part no.	Article no.	Std. pack
100	100	50	-	40	20 - 40	2 - 18	NZMH2-PX40-NA	192576	1 Off
				100	40 - 100	2 - 18	NZMH2-PX100-NA	192577	
				160	64 - 160	2 - 18	NZMH2-PX160-NA	192578	
				250	100 - 250	2 - 12	NZMH2-PX250-NA	192579	

wa\_ren\_00818\_r Symbolphoto



$I_{cu}$ (kA)	$I_{cu}$ (kA)	$I_{cu}$ (kA)	$I_{cu}$ (kA)	Rated current (A)	Setting range (A)	Setting range (kA)	Part no.	Article no.	Std. pack
100	100	50	50	250	100 - 250	2 - 18	NZMH3-PX250-NA	192589	1 Off
				400	160 - 400	2 - 12	NZMH3-PX400-NA	192590	
				600	240 - 600	2 - 8	NZMH3-PX600-NA	192591	

wa\_ren\_01818\_r Symbolphoto



$I_{cu}$ (kA)	$I_{cu}$ (kA)	$I_{cu}$ (kA)	$I_{cu}$ (kA)	Rated current (A)	Setting range (A)	Setting range (kA)	Part no.	Article no.	Std. pack
85	85	50	50	800	320 - 800	2 - 18	NZMH4-PX800-NA	192595	1 Off
				1000	400 - 1000	2 - 18	NZMH4-PX1000-NA	192596	
				1200	480 - 1200	2 - 15	NZMH4-PX1200-NA	192597	

Product Standards	UL 489; CSA-C22.2 No. 5-09; IEC 60947-2; CE marking
UL File No.	E31593
UL Category Control No.	DIV0
CSA File No.	022086
CSA Class No.	1432-01
North America Certification	UL listed, CSA certified
Specially designed for NA	Yes
Suitable for	Feeder circuits, branch circuits
Current Limiting Circuit breaker	No
Max. Voltage Rating	600 V
Degree of Protection	IEC: IP20; UL/CSA Type: -

# 2.5

## Compact circuit breakers, switch disconnectors

Circuit breakers UL/CSA, IEC, thermomagnetic releases, 4 pole  
NZM...-4-AF...NA

Switching capacity				Rated current = Rated uninterrupted current	Setting range			Fixed mounting	Article no.
SCCR 480Y/277 V 60 Hz	SCCR 480 V 60 Hz	SCCR 600Y/347 V 60 Hz	SCCR 600 V 60 Hz		Neutral conductor $I_n$ , x % of phase conductor	Overload releases	Short-circuit releases Non-delayed	Part no.	
$I_{cu}$ kA	$I_{cu}$ kA	$I_{cu}$ kA	$I_{cu}$ kA	$I_n = I_u$ A	$I_r$ A	$I_r = I_n \times \dots$			

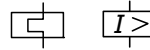

### System and cable protection

Fixed overload releases  $I_r$

#### Basic switching capacity

1230PIC-801 Symbolphoto



$I_{cu}$ kA	$I_{cu}$ kA	$I_{cu}$ kA	$I_{cu}$ kA	Rated current A	Setting range A	Overload releases	Short-circuit releases	Fixed mounting	Article no.
25	25	-	-	60	100	60 A fixed	6 - 10	-	
				70	100	70 A fixed	6 - 10	-	
				80	100	80 A fixed	6 - 10	-	
				90	100	90 A fixed	6 - 10	-	
				100	100	100 A fixed	6 - 10	-	
				110	100	110 A fixed	6 - 10	-	
				125	100	125 A fixed	6 - 10	-	
				150	100	150 A fixed	6 - 10	-	
				175	100	175 A fixed	6 - 10	-	
				200	100	200 A fixed	6 - 10	-	
				225	100	225 A fixed	6 - 10	-	
				250	100	250 A fixed	6 - 10	-	

#### Normal switching capacity

1230PIC-801 Symbolphoto



$I_{cu}$ kA	$I_{cu}$ kA	$I_{cu}$ kA	$I_{cu}$ kA	Rated current A	Setting range A	Overload releases	Short-circuit releases	Fixed mounting	Article no.
35	35	-	-	60	100	60 A fixed	6 - 10	NZMN2-4-AF60-NA	190347
				70	100	70 A fixed	6 - 10	-	
				80	100	80 A fixed	6 - 10	NZMN2-4-AF80-NA	190348
				90	100	90 A fixed	6 - 10	-	
				100	100	100 A fixed	6 - 10	NZMN2-4-AF100-NA	190349
				110	100	110 A fixed	6 - 10	-	
				125	100	125 A fixed	6 - 10	NZMN2-4-AF125-NA	190350
				150	100	150 A fixed	6 - 10	NZMN2-4-AF150-NA	190351
				175	100	175 A fixed	6 - 10	-	
				200	100	200 A fixed	6 - 10	NZMN2-4-AF200-NA	190352
				225	100	225 A fixed	6 - 10	NZMN2-4-AF225-NA	190353
				250	100	250 A fixed	6 - 10	NZMN2-4-AF250-NA	190354

#### High switching capacity

1230PIC-801 Symbolphoto



$I_{cu}$ kA	$I_{cu}$ kA	$I_{cu}$ kA	$I_{cu}$ kA	Rated current A	Setting range A	Overload releases	Short-circuit releases	Fixed mounting	Article no.
150	150	-	-	60	100	60 A fixed	6 - 10	-	
				70	100	70 A fixed	6 - 10	-	
				80	100	80 A fixed	6 - 10	-	
				90	100	90 A fixed	6 - 10	-	
				100	100	100 A fixed	6 - 10	-	
				110	100	110 A fixed	6 - 10	-	
				125	100	125 A fixed	6 - 10	-	
				150	100	150 A fixed	6 - 10	-	
				175	100	175 A fixed	6 - 10	-	
				200	100	200 A fixed	6 - 10	-	
				225	100	225 A fixed	6 - 10	-	
				250	100	250 A fixed	6 - 10	NZMH2-4-AF250-NA	172967



# Compact circuit breakers, switch disconnectors

# 2.5

Circuit breakers UL/CSA, IEC, thermomagnetic releases, 4 pole  
NZM...-4-AF...NA

## Fixed mounting with box terminals

Part no.

Article no.

Std. pack

Information relevant for export to North America



For further terminal types  
see accessories

Part no.	Article no.	Std. pack	Information relevant for export to North America
NZMB2-4-AF60-BT-NA	153380	1 Off	Product Standards UL 489; CSA-C22.2 No. 5-09; IEC 60947-2; CE marking
NZMB2-4-AF70-BT-NA	153381		UL File No. E31593
NZMB2-4-AF80-BT-NA	153382		UL Category Control No. DIVQ
NZMB2-4-AF90-BT-NA	153383		CSA File No. -
NZMB2-4-AF100-BT-NA	153384		CSA Class No. -
NZMB2-4-AF110-BT-NA	153385		North America Certification UL listed
NZMB2-4-AF125-BT-NA	113011		Specially designed for NA Yes
NZMB2-4-AF150-BT-NA	113012		Suitable for Feeder circuits, branch circuits
NZMB2-4-AF175-BT-NA	113013		Current Limiting Circuit breaker Yes
NZMB2-4-AF200-BT-NA	113014		Max. Voltage Rating 480 V
NZMB2-4-AF225-BT-NA	113015		Degree of Protection IEC: IP20; UL/CSA Type: -
NZMB2-4-AF250-BT-NA	113016		

Part no.	Article no.	Std. pack	Information relevant for export to North America
NZMN2-4-AF60-BT-NA	153386	1 Off	Product Standards UL 489; CSA-C22.2 No. 5-09; IEC 60947-2; CE marking
NZMN2-4-AF70-BT-NA	153387		UL File No. E31593
NZMN2-4-AF80-BT-NA	153388		UL Category Control No. DIVQ
NZMN2-4-AF90-BT-NA	153389		CSA File No. -
NZMN2-4-AF100-BT-NA	153390		CSA Class No. -
NZMN2-4-AF110-BT-NA	153391		North America Certification UL listed
NZMN2-4-AF125-BT-NA	113005		Specially designed for NA Yes
NZMN2-4-AF150-BT-NA	113006		Suitable for Feeder circuits, branch circuits
NZMN2-4-AF175-BT-NA	113007		Current Limiting Circuit breaker Yes
NZMN2-4-AF200-BT-NA	113008		Max. Voltage Rating 480 V
NZMN2-4-AF225-BT-NA	113009		Degree of Protection IEC: IP20; UL/CSA Type: -
NZMN2-4-AF250-BT-NA	113010		

Part no.	Article no.	Std. pack	Information relevant for export to North America
NZMH2-4-AF60-BT-NA	153392	1 Off	Product Standards UL 489; CSA-C22.2 No. 5-09; IEC 60947-2; CE marking
NZMH2-4-AF70-BT-NA	153393		UL File No. E31593
NZMH2-4-AF80-BT-NA	153394		UL Category Control No. DIVQ
NZMH2-4-AF90-BT-NA	153395		CSA File No. -
NZMH2-4-AF100-BT-NA	153396		CSA Class No. -
NZMH2-4-AF110-BT-NA	153397		North America Certification UL listed
NZMH2-4-AF125-BT-NA	113017		Specially designed for NA Yes
NZMH2-4-AF150-BT-NA	113018		Suitable for Feeder circuits, branch circuits
NZMH2-4-AF175-BT-NA	113019		Current Limiting Circuit breaker Yes
NZMH2-4-AF200-BT-NA	113020		Max. Voltage Rating 480 V
NZMH2-4-AF225-BT-NA	113021		Degree of Protection IEC: IP20; UL/CSA Type: -
NZMH2-4-AF250-BT-NA	113022		

# 2.6

## Compact circuit breakers, switch disconnectors

Molded case switches for North America  
NS...NA

Switching capacity				Rated current = Rated uninterrupted current	Setting range Short-circuit release	Fixed mounting Part no.	Article no.
SCCR 480Y/277 V 60 Hz	SCCR 480 V 60 Hz	SCCR 600Y/347 V 60 Hz	SCCR 600 V 60 Hz				
$I_{cu}$ kA	$I_{cu}$ kA	$I_{cu}$ kA	$I_{cu}$ kA	$I_n = I_u$ A	$I_i$ A		

### Molded case switches for North America

With permanently set short-circuit release (self-protection)

Can be remotely operated with shunt release XU/XA, remote operator XR,

Can be equipped with trip-indicating auxiliary contact M22-K..

#### 3 switch positions I, +, 0

1230PIC-752 Symbolphoto



35	-	-	-	63	1250 A fixed	NS1-63-NA	102681
				100	1250 A fixed	NS1-100-NA	102682
				125	1250 A fixed	NS1-125-NA	102683

1230PIC-796 Symbolphoto



100	100	50	-	160	2500 A fixed	NS2-160-NA	102684
				200	2500 A fixed	NS2-200-NA	102685
				250	2500 A fixed	NS2-250-NA	102686

1230PIC-671 Symbolphoto



100	100	50	50	400	6600 A fixed	NS3-400-NA	102687
				600	6600 A fixed	NS3-600-NA	102688

1230PIC-674 Symbolphoto



65	65	42	42	800	25000 A fixed	NS4-800-NA	102689
				1000	25000 A fixed	NS4-1000-NA	102690
				1200	25000 A fixed	NS4-1200-NA	102691

# Compact circuit breakers, switch disconnectors

## Molded case switches for North America NS...NA

# 2.6

Fixed mounting with box terminals  
Part no.

Article no.

Std. pack

Information relevant for export to North America



For further terminal types  
see accessories

Terminals as accessory	1 Off		Product Standards	UL 489; CSA-C22.2 No. 5-09; IEC 60947-2; CE marking
			UL File No.	E148671
			UL Category Control No.	WJAZ
			CSA File No.	022086
			CSA Class No.	4652-06
			North America Certification	UL listed, CSA certified
			Specially designed for NA	Yes
			Suitable for	Feeder circuits, branch circuits
			Current Limiting Circuit breaker	No
			Max. Voltage Rating	480Y/277 V
			Degree of Protection	IEC: IP20; UL/CSA Type: -

NS2-160-BT-NA	107578		Product Standards	UL 489; CSA-C22.2 No. 5-09; IEC 60947-2; CE marking
NS2-200-BT-NA	107579		UL File No.	E148671
NS2-250-BT-NA	107610		UL Category Control No.	WJAZ
			CSA File No.	022086
			CSA Class No.	4652-06
			North America Certification	UL listed, CSA certified
			Specially designed for NA	Yes
			Suitable for	Feeder circuits, branch circuits
			Current Limiting Circuit breaker	No
			Max. Voltage Rating	600Y/347 V
			Degree of Protection	IEC: IP20; UL/CSA Type: -



Terminals as accessory			Product Standards	UL 489; CSA-C22.2 No. 5-09; IEC 60947-2; CE marking
			UL File No.	E148671
			UL Category Control No.	WJAZ
			CSA File No.	022086
			CSA Class No.	4652-06
			North America Certification	UL listed, CSA certified
			Specially designed for NA	Yes
			Suitable for	Feeder circuits, branch circuits
			Current Limiting Circuit breaker	No
			Max. Voltage Rating	600 V
			Degree of Protection	IEC: IP20; UL/CSA Type: -

Terminals as accessory			Product Standards	UL 489; CSA-C22.2 No. 5-09; IEC 60947-2; CE marking
			UL File No.	E148671
			UL Category Control No.	WJAZ
			CSA File No.	022086
			CSA Class No.	4652-06
			North America Certification	UL listed, CSA certified
			Specially designed for NA	Yes
			Suitable for	Feeder circuits, branch circuits
			Current Limiting Circuit breaker	No
			Max. Voltage Rating	600 V
			Degree of Protection	IEC: IP20; UL/CSA Type: -

# 3.1

## Compact circuit breakers, switch disconnectors

Circuit breakers IEC for 1000 V AC, 3 pole  
NZM... Releases

Switching capacity 1000 V 50/60 Hz	Rated current = Rated uninterrupted current	Setting range		Fixed mounting Part no.	Article no.	Std. pack
		Overload releases	Short-circuit releases Non-delayed			
$I_{cu}$ kA	$I_n = I_u$ A	$I_r$ A	$I_{sd} = I_r \times \dots$			
						

### System and cable protection

#### Thermomagnetic releases

1230PIC-802 Symbolphoto



10	20	15 - 20	350 A fixed	NZMH2-A20-S1	290355	1 Off
	25	20 - 25	350 A fixed	NZMH2-A25-S1	290356	
	32	25 - 32	350 A fixed	NZMH2-A32-S1	290357	
	40	32 - 40	8 - 10	NZMH2-A40-S1	290358	
	50	40 - 50	6 - 10	NZMH2-A50-S1	290359	
	63	50 - 63	6 - 10	NZMH2-A63-S1	290360	
	80	63 - 80	6 - 10	NZMH2-A80-S1	290361	
	100	80 - 100	6 - 10	NZMH2-A100-S1	290362	
	125	100 - 125	6 - 10	NZMH2-A125-S1	290363	
	160	125 - 160	6 - 10	NZMH2-A160-S1	290364	
	200	160 - 200	6 - 10	NZMH2-A200-S1	290365	
	250	200 - 250	6 - 10	NZMH2-A250-S1	290366	
	300	120 - 300	5 - 8.3	NZMH2-A300-S1	107577	

# Compact circuit breakers, switch disconnectors

Switch disconnectors UL/CSA, IEC for 1000 V DC, 1/2 pole  
N...DC

# 3.2

Rated current =				Short-circuit protection	Fixed mounting	Article no.	Std. pack
Rated uninterrupted current	Rated operating voltage	Rated short-time withstand current		max. fuse gR characteristic	Part no.		
$I_n$	$U_e$	$I_{cw}$ (N2/N3: t=1s, N4: t=0.1s)					
A	V	kA		A			

## Switch disconnectors for 1000 V DC

1230PIC-797 Symbolphoto



160	1000	3.6	200	N2-4-160-S1-DC	127732	1 Off
200	1000	3.6	200	N2-4-200-S1-DC	127733	
250	1000	3.6	200	N2-4-250-S1-DC	154940	

1230PIC-672 Symbolphoto



320	1000	6.6	2x250	N3-4-320-S1-DC	127734	1 Off
400	1000	6.6	2x250	N3-4-400-S1-DC	142267	
500	1000	6.6	2x250	N3-4-500-S1-DC	142268	
550	1000	6.6	2x250	N3-4-550-S1-DC	168567	

1230PIC-672 Symbolphoto



800	1000	34	-	N4-4-800-S1-DC	119890	1 Off
1000	1000	34	-	N4-4-1000-S1-DC	119891	
1250	1000	34	-	N4-4-1250-S1-DC	119886	
1400	1000	34	-	N4-4-1400-S1-DC	119887	
1600	1000	34	-	N4-4-1600-S1-DC	152552	

1230PIC-673 Symbolphoto



800	1000	34	-	N4-4-800-S1-PV-NA	179325	1 Off
1000	1000	34	-	N4-4-1000-S1-PV-NA	179326	
1100	1000	34	-	N4-4-1100-S1-PV-NA	179591	
1200	1000	34	-	N4-4-1200-S1-PV-NA	179327	

# 3.3

## Compact circuit breakers, switch disconnectors

Switch disconnectors UL/CSA, IEC for 1500 V DC, 1/2 pole  
N...DC

Rated current =				Short-circuit protection	Fixed mounting	Article no.	Std. pack
Rated uninterrupted current	Rated operating voltage	Rated short-time withstand current		max. fuse gR characteristic	Part no.		
$I_n$	$U_e$	$I_{cw}$ (N2/N3: t=1s, N4: t=0.1s)					
A	V	kA		A			

### Switch disconnectors for 1500 V DC

1230PIC-797 Symbolphoto



160	1500	3.6	-	N2-4-160-S15-DC	167688	1 Off
200	1500	3.6	-	N2-4-200-S15-DC	167689	
250	1500	3.6	-	N2-4-250-S15-DC	167690	

1230PIC-672 Symbolphoto



320	1500	6.6	-	N3-4-320-S15-DC	166407	1 Off
400	1500	6.6	-	N3-4-400-S15-DC	166408	
500	1500	6.6	-	N3-4-500-S15-DC	166409	
550	1500	6.6	-	N3-4-550-S15-DC	168568	

1230PIC-672 Symbolphoto



800	1500	34	-	N4-4-800-S15-DC	166413	1 Off
1000	1500	34	-	N4-4-1000-S15-DC	166414	
1250	1500	34	-	N4-4-1250-S15-DC	166415	
1400	1500	34	-	N4-4-1400-S15-DC	166416	
1600	1500	34	-	N4-4-1600-S15-DC	166417	

1230PIC-673 Symbolphoto



800	1500	34	-	N4-4-800-S15-PV-NA	179328	1 Off
1000	1500	34	-	N4-4-1000-S15-PV-NA	179329	
1100	1500	34	-	N4-4-1100-S15-PV-NA	179592	
1200	1500	34	-	N4-4-1200-S15-PV-NA	179330	



# 3.4

## Compact circuit breakers, switch disconnectors

Photovoltaic - Switch disconnectors up to 1500 V  
Bridge kits

Rated current =	Protection class	For use with	Notes	Part no.	Article no.	Std. pack
2 pole (+ and -) on one side						
$I_n$ A						

### Bridge kits NZM...-XKV...2P...

Model contains parts for upper or lower row of switchgear side for 4 pole switches N4-4...-S1(S15)...

that are used as 2 pole switches for DC

The links each connect two contacts in series

Incoming unit and outgoing at bottom according to the switching diagrams

N4-4... ≥1250A at 65°C alternate connection at bottom through module plates NZM4-4-XKM2S-1600

For IEC application: For N4-4...-S15-PV-NA, feed only from below in connection with NZM4-4-XKV(I)2P(-K).

1230PIC-690, 1230PIC-1015 Symbolphoto



#### Incl. cover

225 (40°C), 170 (65°C)	IP2X	N2-4...-S1(-S15)-DC		NZM2-4-XKV2P	131730	1 Off
250 (40°C), 190 (65°C)	IP2X	N2-4...-S1(-S15)-DC	Incl. cooling unit	NZM2-4-XKV2P-K	168585	
517 (40°C), 435 (65°C)	IP2X	N3-4...-S1(-S15)-DC		NZM3-4-XKV2P	131731	
550 (40°C), 468 (65°C)	IP2X	N3-4...-S1(-S15)-DC	Incl. cooling unit	NZM3-4-XKV2P-K	142271	
1400 (40°C) 1260 (65°C)	IP2X	N4-4...-S1(-S15)-DC N4-4...-S1(-S15)-PV-NA		NZM4-4-XKV2P	119888	

1230PIC-1016, 1230PIC-1017 Symbolphoto



#### Incl. insulation plates and phase separator

238 (40°C) 180 (65°C)	IP00	N2-4...-S1(-S15)-DC		NZM2-4-XKV12P	168586	1 Off
250 (40°C) 213 (65°C)	IP00	N2-4...-S1(-S15)-DC	Incl. cooling unit	NZM2-4-XKV12P-K	168587	
400 (40°C), 338 (65°C)	IP2X	N3-4...-S1(-S15)-DC		NZM3-4-XKV2POU	168589	
550 (40°C) 501 (65°C)	IP00	N3-4...-S1(-S15)-DC	Incl. cooling unit	NZM3-4-XKV12P-K	142270	
1400A (40°C) 1260A (65°C)	IP00	N4-4-800(1000)(1250)(1400)-S1(S15)-DC N4-4...-S1(S15)-PV-NA		NZM4-4-XKV12P	180020	
1600 (40°C) 1500 (65°C)	IP00	N4-4...-S1(-S15)-DC N4-4...-S1(-S15)-PV-NA	Incl. cooling unit	NZM4-4-XKV2P-K	152553	



Rated current =	Protection class	For use with class	Notes	Part no.	Article no.	Std. pack
2 pole (+ and -) Double-sided						
$I_n$ A						

### Bridge kits NZM...-XKV...2POU...

Model contains parts for upper and lower row of switchgear side for 4 pole switches N...-S1(S15)-DC that are used as 2 pole switches for DC

The links each connect three contacts in series

Incoming unit and outgoing at bottom or top, according to the switching diagrams

1230PIC-1138, 1230PIC-1311 Symbolphoto



#### Incl. cover

200 (40°C) 160 (65°C)	IP2X	N2-4-...-S1(-S15)-DC		NZM2-4-XKV2POU	144070	1 Off
225 (40°C) 170 (65°C)	IP2X	N2-4-...-S1(-S15)-DC	Incl. cooling unit	NZM2-4-XKV2POU-K	168588	
400 (40°C) 388 (65°C)	IP2X	N3-4-...-S1(S15)-DC		NZM3-4-XKV2POU	168589	
517 (40°C) 435 (65°C)	IP2X	N3-4-...-S1(-S15)-DC	Incl. cooling unit	NZM3-4-XKV2POU-K	168590	

1230PIC-1144, 1230PIC-1146 Symbolphoto

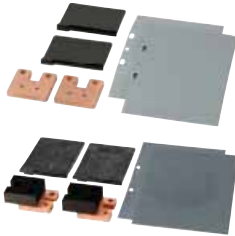

#### Incl. insulation plates and phase separator

213 (40°C) 160 (65°C)	IP00	N2-4-...-S1(-S15)-DC		NZM2-4-XKV12POU	170118	1 Off
238 (40°C) 180 (65°C)	IP00	N2-4-...-S1(-S15)-DC	Incl. cooling unit	NZM2-4-XKV12POU-K	170119	
501 (40°C) 418 (65°C)	IP00	N3-4-...-S1(-S15)-DC		NZM3-4-XKV12POU	170120	
534 (40°C) 451 (65°C)	IP00	N3-4-...-S1(-S15)-DC	Incl. cooling unit	NZM3-4-XKV12POU-K	170121	

# 3.4

## Compact circuit breakers, switch disconnectors

Photovoltaic - Switch disconnectors up to 1500 V  
Bridge kits

Rated current =	Protection class	For use with	Notex	Part no.	Article no.	Std. pack
1 pole (+ or -) on one side						
$I_n$ A						

### Bridge kits NZM...-XKV...1P...

Model contains parts for upper and lower row of switchgear side for 4 pole switches N4-4...-S1(S15)... that are used as 1 pole switches for DC

The links each connect four contact in series (plus or minus)

Incoming unit and outgoing at bottom or top, according to the switching diagrams

1230PIC-1313, 1230PIC-1310 Symbolphoto

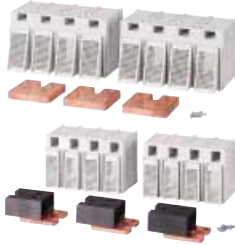

Incl. cover						
200 (40°C) 160 (65°C)	IP2X	N2-4-160(200)-S1 (-S15)-DC		NZM2-4-XKV1P	168591	1 Off
225 (40°C) 170 (65°C)	IP2X	N2-4-...-S1(-S15)-DC	Incl. cooling unit	NZM2-4-XKV1P-K	168592	
400 (40°C) 338 (65°C)	IP2X	N3-4-320(400)-S1(-S15)-DC		NZM3-4-XKV1P	168593	
517 (40°C) 435 (65°C)	IP2X	N3-4-400(500)-S1(-S15)-DC	Incl. cooling unit	NZM3-4-XKV1P-K	168594	
1274 (40°C) 1138 (65°C)	IP2X	N4-4-...-S1(-S15)-DC N4-4-800(1000)(1100)-S1(-S15)-PV-NA		NZM4-4-XKV1P	119889	

1230PIC-1145, 1230PIC-1315 Symbolphoto

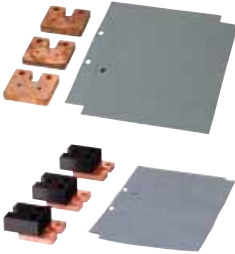



Incl. insulation plates						
213 (40°C) 160 (65°C)	IP00	N2-4-...-S1(-S15)-DC		NZM2-4-XKV1P	168595	1 Off
238 (40°C) 180 (65°C)	IP00	N2-4-200(250)-S1(-S15)-DC	Incl. cooling unit	NZM2-4-XKV1P-K	168596	
501 (40°C) 418 (65°C)	IP00	N3-4-...-S1(S15)-DC		NZM3-4-XKV1P	168597	
534 (40°C) 451 (65°C)	IP00	N3-4-...-S1(S15)-DC	Incl. cooling unit	NZM3-4-XKV1P-K	168598	
1260 (40°C) 1138 (65°C)	IP00	N4-4-(800)(1000)(1250)(1400)-S1(-S15)-DC N4-4-...-S1(-S15)-PV-NA		NZM4-4-XKV1P	180019	
1552 (40°C) 1448 (65°C)	IP00	N4-4-...-S1(-S15)-DC N4-4-...-S1(-S15)-PV-NA	Incl. cooling unit	NZM4-4-XKV1P-K	179331	

# Compact circuit breakers, switch disconnectors



# 3.5

Circuit breakers EC for 500/750 V DC, 1/2 pole  
 NZM... -A Releases

Switching capacity 1000 V 50/60 Hz	Rated current = Rated uninterrupted current	Setting range		Fixed mounting Part no.	Article no.	Std. pack
		Overload releases	Short-circuit releases Non-delayed			
$I_{cu}$ kA	$I_n = I_u$ A	$I_r$ A	$I_{sd} = I_n \dots$			
						

## System and cable protection

### Thermomagnetic -A Releases

1230PIC-703 Symbolphoto	30	400	320 - 400	2150 A DC fixed	NZMN3-A400-S07-DC	189599	1 Off
							
1230PIC-702 Symbolphoto	30	400	320 - 400	2150 A DC fixed	NZMN3-A400-S07-DC-PIT	189600	1 Off
							

# 4.1

## Compact circuit breakers, switch disconnectors

### Terminals NZM1

Max. cable connection area	Number of poles	For use with	Terminal capacity		Terminal capacity		
			Cable Cable lugs	Terminal capacity mm <sup>2</sup>	AWG/kcmil	Copper strip No. of discs x width x disc thickness mm	Copper bar Width x thickness mm

#### Box terminal

Standard equipment

1230PIC-721 Symbolphoto

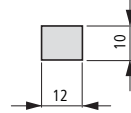

3 pole	NZM1, PN1, N(S)1	Copper cable	1 x 10 - 70 2 x 6 - 25 1)	1 x 12 - 2/0	≥ 2 x 9 x 0.8	-
4 pole	NZM1-4, PN1-4, N1-4	Copper cable	1 x 10 - 70 2 x 6 - 25 1)	1 x 12 - 2/0	≥ 2 x 9 x 0.8	-

#### Screw terminals

sg08415 Symbolphoto

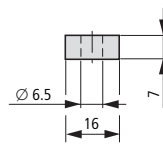

1 pole	NZM1-1	Copper cable lugs	1 x 10 - 70 2 x 6 - 25	1 x 12 - 2/0	-	≥ 12 x 5
		Aluminium cable lugs	1 x 10 - 35 2 x 10 - 35 1)			
3 pole	NZM1, PN1, N(S)1	Copper cable lugs	1 x 10 - 70 2 x 6 - 25	1 x 12 - 2/0	-	≥ 12 x 5
		Aluminium cable lugs	1 x 10 - 35 2 x 10 - 35 1)			
4 pole	NZM1-4, PN1-4, N1-4	Copper cable lugs	1 x 10 - 70 2 x 6 - 25	1 x 12 - 2/0	-	≥ 12 x 5
		Aluminium cable lugs	1 x 10 - 35 2 x 10 - 35 1)			

1230PIC-677 Symbolphoto



Notes: <sup>1)</sup> Up to 95 mm<sup>2</sup> can be connected depending on make of cable

Part no. Article no. Std. pack Notes Information relevant for export to North America

Article no.  
when ordered separately



Part no.	Article no.	Std. pack	Notes	Information relevant for export to North America
NZM1-XKC	260015	1 set 	Standard connection with all NZM1, PN1 and N(S)1 switches. Conversion kit for circuit breaker with screw terminal. Contains parts for a 3 or 4 pole switch side. Fitted within the switch housing. Use ferrules with flexible and highly flexible conductors. Max. cross section shown can only be connected when flexible and without ferrules.	Product Standards UL 489; CSA-C22.2 No. 5-09; IEC 60947; CE marking UL File No. E31593 UL CCN DIHS CSA File No. 022086 CSA Class No. 1437-01 NA Certification UL Listed, CSA certified Suitable for Refer to main component information
NZM1-4-XKC	267075	1 set		-
NZM1-1-XKS	152620	1 set 	Contains parts for a terminal located at top or bottom for 1 pole circuit breaker. Flush mounting outside the switch housing. Cover NZM1(-4)-XKSA must be fitted (included as standard).	-
NZM1-XKS	260019	1 set 	Contains parts for a terminal located at top or bottom for 3 or 4 pole circuit breakers. Flush mounting outside the switch housing. Cover NZM1(-4)-XKSA must be fitted (included as standard).	Product Standards UL 489; CSA-C22.2 No. 5-09; IEC 60947; CE marking UL File No. E31593 UL CCN DIHS CSA File No. 022086 CSA Class No. 1437-01 NA Certification UL Listed, CSA certified Suitable for Refer to main component information
NZM1-4-XKS	266725	1 set		-

# 4.1

## Compact circuit breakers, switch disconnectors

### Terminals NZM1

	Max. cable connection area	Number of poles	For use with	Terminal capacity		Terminal capacity		
				Cable lugs	Terminal capacity mm <sup>2</sup>	AWG/kcmil	Copper strip No. of discs x width x disc thickness mm	Copper bar Width x thickness mm
<b>Tunnel terminal</b>								
sg08115 Symbolphoto 		3 pole	NZM1, PN1, N(S)1	Copper cable ☉▽ 6 x 2.5 - 16 Aluminium cable <sup>1)</sup> ☉▽	6 x 14 - 6	-	-	-
1230PIC-683 Symbolphoto 			NZM1, PN1, N(S)1	Copper cable ☉▽ 1 x 16 - 95 Aluminium cable <sup>1)</sup> ☉▽	1 x 6 - 3/0	-	-	-
sg08015 Symbolphoto 		4 pole	NZM1-4, PN1-4, N1-4	Copper cable ☉▽ 6 x 2.5 - 16 Aluminium cable <sup>1)</sup> ☉▽	6 x 14 - 6	-	-	-
1230PIC-676 Symbolphoto 			NZM1-4, PN1-4, N1-4	Copper cable ☉▽ 1 x 16 - 95 Aluminium cable <sup>1)</sup> ☉▽	1 x 6 - 3/0	-	-	-
<b>Rear terminal bolts</b> Not UL/CSA approved								
1230PIC-1428 Symbolphoto 	-	3 pole	NZM1, PN1, N1	Copper cable lugs Aluminium cable lugs	1 x 10 - 70 2 x 6 - 25	-	-	min. 12 x 5 max. 16 x 5
1230PIC-898 Symbolphoto 	-	4 pole	NZM1-4, PN1-4, N1-4	Copper cable lugs Aluminium cable lugs	1 x 10 - 70 2 x 6 - 25	-	-	min. 12 x 5 max. 16 x 5
<b>Control cable terminals</b>								
1230PIC-729 Symbolphoto 	-	3 and 4 pole	NZM1(-4), PN1(-4), N(S)1(-4)	Screw terminals	1 x 0.75 - 2.5 2 x 0.75 - 1.5	1 x 18 - 14 2 x 18 - 16	-	-
1230PIC-747 Symbolphoto 	-	3 and 4 pole	NZM1(-4), PN1(-4), N(S)1(-4)	Screw terminals	1 x 0.75 - 2.5 2 x 0.75 - 1.5	1 x 18 - 14 2 x 18 - 16	-	-

Notes: <sup>1)</sup> Up to 95 mm<sup>2</sup> can be connected depending on make of cable

Part no. Article no. Std. pack Notes

Information relevant for export to North America

Article no.  
when ordered separately



Part no.	Article no.	Std. pack	Notes	Information relevant for export to North America
NZM1-XKAM	144112	1 set	<p>Contains parts for a terminal located at top or bottom for 3 or 4 pole switches. With control circuit terminal for 1 x 0.75 - 2.5 mm<sup>2</sup> (18 - 14 AWG) or 2 x 0.75 - 1.5 mm<sup>2</sup> (18 - 14 AWG) copper conductor. Flush mounting outside the switch housing. Use ferrules with flexible and highly flexible conductors. Max. cross section shown can only be connected when flexible and without ferrules. Cover NZM1(-4)-XKSA must be fitted (included as standard).</p>	<p>Product Standards UL 489; CSA-C22.2 No. 5-09; IEC 60947; CE marking UL File No. E31593 UL CCN DIHS CSA File No. 022086 CSA Class No. 1437-01 NA Certification UL Listed, CSA certified Suitable for Refer to main component information</p>
NZM1-XKA	266730			
NZM1-4-XKAM	144114	1 set	-	-
NZM1-4-XKA	266731			
NZM1-XKR	266734	1 set	Contains parts for a terminal located at top or bottom for 3 or 4 pole circuit breakers.	-
NZM1-4-XKR	266737	1 set		-
NZM1-XSTS	260150	1 set	<p>Contains for two terminal locations located at top or bottom for 3 or 4 pole circuit breakers. Included as standard with tunnel terminal. Degree of protection IP1X NZM-XSTK cannot be combined with NZM1(-4)-XIPK IP2X protection against contact with a finger. Height or thickness of connections: NZM-XSTK = 2 mm NZM-XSTS = 2 mm</p>	<p>Product Standards UL 489; CSA-C22.2 No. 5-09; IEC 60947; CE marking UL File No. E140305 UL CCN DIHS CSA File No. 022086 CSA Class No. 1437-01 NA Certification UL Listed, CSA certified Suitable for Refer to main component information</p>
NZM-XSTK	266739			

# 4.1

## Compact circuit breakers, switch disconnectors

### Terminals NZM1

	Max. cable connection area	Number of poles	For use with	Connection	Terminal capacity mm <sup>2</sup>	AWG/kcmil
<b>Terminal covers knockout</b> Not UL/CSA approved. For box terminal						
1230PIC-176 Symbolphoto 	-	3 pole	NZM1, PN1, N1	-	-	-
1230PIC-678 Symbolphoto 	-	4 pole	NZM1-4, PN1-4, N1-4	-	-	-
<b>Cover</b>						
wia_sg02316 Symbolphoto 	-	1 pole	NZM1-1	-	-	-
1230PIC-686 Symbolphoto 	-	3 pole	NZM1, PN1, N1	-	-	-
1230PIC-686 Symbolphoto 	-	4 pole	NZM1-4, PN1-4, N1-4	-	-	-
<b>Phase isolators</b>						
sg09115 Symbolphoto 	-	3 pole	NZM1, PN1, N(S)1	-	-	-
1230PIC-1014 Symbolphoto 	-	4 pole	NZM1-4, PN1-4, N1-4	-	-	-



Part no. Article no. Std. pack Notes Information relevant for export to North America

Article no.  
when ordered separately









Part no.	Article no.	Std. pack	Notes	Information relevant for export to North America
NZM1-XKSFA	100780	1 Off	Contains parts for a terminal located at top or bottom for 3 or 4 pole circuit breakers. Enhanced contact protection (simplified finger protection). Cannot be combined with NZM-XSTK control circuit terminal.	UL/CSA certification not required
NZM1-XKSFA-GVP	112632	50 Off		
NZM1-4-XKSFA	100781	1 Off	-	-
NZM1-1-XKSA	152549	1 Off	Contains parts for a terminal located at top or bottom for 1 pole switches. Contact protection against direct contact where cable lugs, bars or tunnel terminals are used. When using insulated conductor material to degree of protection IP1X.	-
NZM1-XKSA	260021	1 Off	Contains parts for a terminal located at top or bottom for 3 or 4 pole switches. Contact protection against direct contact where cable lugs, bars or tunnel terminals are used. Contained in the set with tunnel terminals and screw terminals. When using insulated conductor material to degree of protection IP1X	Product Standards UL 489; CSA-C22.2 No. 5-09; IEC 60947; CE marking UL File No. E31593 UL CCN DIHS CSA File No. 022086 CSA Class No. 1437-01 NA Certification UL Listed, CSA certified Suitable for Refer to main component information
NZM1-4-XKSA	266741	1 Off		-
NZM1-XKP	119862	1 set	Contains parts, including insulating plate for mounting plate, for a terminal located at top or bottom for 3 or 4 pole circuit breakers. Can not be combined with connection on rear NZM1/2(-4)-XKR. Insulation protection up to a rated operating voltage $U_n$ von 415V AC when minimum distances are not maintained.	UL/CSA certification not required
NZM1-4-XKP	119863	1 set		

# 4.1

## Compact circuit breakers, switch disconnectors

### Terminals NZM1

	Max. cable connection area	Number of poles	For use with	Connection	Terminal capacity	AWG/kcmil
<b>IP2X Protection against contact with finger</b>						
For box terminal						
1230PIC-1360 Symbolphoto 	-	1 pole	NZM1-1	-	-	-
1230PIC-1368 Symbolphoto 	-	3 pole	NZM1, PN1, N1	-	-	-
1230PIC-675 Symbolphoto 	-	4 pole	NZM1-4, PN1-4, N1-4	-	-	-
<b>IP2X Protection against contact with finger</b>						
For covers NZM1(-4)-XKSA or NZM1...(C)NA, N(S)1...NA						
1230PIC-1359 Symbolphoto 	-	1 pole	NZM1-1	-	-	-
1230PIC-1367 Symbolphoto 	-	3 pole	NZM1, PN1, N1	-	-	-
1230PIC-720 Symbolphoto 	-	4 pole	NZM1-4, PN1-4, N1-4	-	-	-

Part no. Article no. Std. pack Notes Information relevant for export to North America

Article no.  
when ordered separately







NZM1-1-XIPK	152551	1 set	Contains parts for a terminal located at top or bottom for 1 pole switches. Enhanced contact protection to IP2X. Protection when reaching into the cable connection area with the connection of cables in the box terminal. Cannot be combined with NZM-XSTK control circuit terminal.	UL/CSA certification not required
NZM1-XIPK	266744	1 set	Contains parts for a terminal located at top or bottom for 3 or 4 pole switches Enhanced contact protection to IP2X. Protection when reaching into the cable connection area with the connection of cables in the box terminal. Cannot be combined with NZM-XSTK control circuit terminal.	UL/CSA certification not required
NZM1-4-XIPK	266745	1 set		-

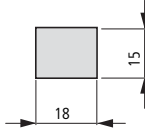

NZM1-1-XIPA	152550	1 set	Contains parts for a terminal located at top or bottom for 1 pole switches. Enhanced contact protection to IP2X.	UL/CSA certification not required
NZM1-XIPA	266748	1 set	Contains parts for a terminal located at top or bottom for 3 or 4 pole switches. Enhanced contact protection to IP2X.	UL/CSA certification not required
NZM1-4-XIPA	266749	1 set		-

# 4.2

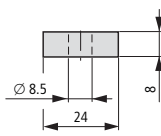
## Compact circuit breakers, switch disconnectors

### Terminals NZM2

Max. cable connection area	Number of poles	For use with	Terminal capacity		Terminal capacity		
			Cable Cable lugs	Terminal capacity mm <sup>2</sup>	AWG/kcmil	Copper strip No. of discs x width x disc thickness mm	Copper bar Width x thickness mm
<b>Box terminal</b>							
1230PIC-725 Symbolphoto 		3 pole	NZM2, PN2, N(S)2 ≤ 160 A	Copper cable 1 x 10 - 185 2 x 4 - 70	1 x 12 - 350	≥ 2 x 9 x 0.8	-
			NZM2, PN2, N(S)2 > 160 A	Copper cable 1 x 10 - 185 2 x 4 - 70	1 x 12 - 350	≥ 2 x 9 x 0.8	-
1230PIC-721 Symbolphoto 		4 pole	NZM2-4, PN2-4, N2-4 ≤ 160 A	Copper cable 1 x 10 - 185 2 x 4 - 70	1 x 12 - 350	≥ 2 x 9 x 0.8	-
			NZM2-4, PN2-4, N2-4 > 160 A	Copper cable 1 x 10 - 185 2 x 4 - 70	1 x 12 - 350	≥ 2 x 9 x 0.8	-
<b>Screw terminals</b>							
Standard equipment							
1230PIC-731 Symbolphoto 		3 pole	NZM2, PN2, N(S)2	Copper cable lugs 1 x 10 - 185 2 x 4 - 70	1 x 12 - 350	≥ 2 x 16 x 0.8	≥ 16 x 5
				Aluminium cable lugs 1 x 10 - 50 2 x 10 - 50			
1230PIC-725 Symbolphoto 		4 pole	NZM2-4, PN2-4, N2-4	Copper cable lugs 1 x 10 - 185 2 x 4 - 70	1 x 12 - 350	≥ 2 x 16 x 0.8	≥ 16 x 5
				Aluminium cable lugs 1 x 10 - 50 2 x 10 - 50			







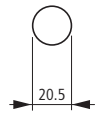

Part no. suffix	Article no.	Part no.	Article no.	Std. pack	Notes	Information relevant for export to North America
Article no. for ordering with basic device		Article no. when ordering separately				
+NZM2-160-XKCO	262218	NZM2-160-XKC	262240	1 set	Part no. suffix and part no. contain parts for a circuit breaker side at top or bottom for 3 or 4 pole switches. Conversion kit for circuit breaker with screw terminal. Fitted within the switch housing. O = for fitting at the top U = for fitting at the bottom $U_e \geq 525$ V AC: Use NZM2(-4)-XKSA cover.	Product Standards UL 489; CSA-C22.2 No. 5-09; IEC 60947; CE marking UL File No. E31593 UL CCN DIHS CSA File No. 022086 CSA Class No. 1432-01 NA Certification UL Listed, CSA certified Suitable for Refer to main component information
+NZM2-160-XKCU	262223	-				
+NZM2-250-XKCO	262242	NZM2-250-XKC	262244	1 set	Use ferrules with flexible and highly flexible conductors. Max. cross section shown can only be connected when flexible and without ferrules.	-
+NZM2-250-XKCU	262243	-				
+NZM2-4-160-XKCO	266751	NZM2-4-160-XKC	266755			
+NZM2-4-160-XKCU	266753	-				
+NZM2-4-250-XKCO	266752	NZM2-4-250-XKC	266756			
+NZM2-4-250-XKCU	266754	-				

-		NZM2-XKS	260030	1 set	Contains parts for a terminal located at top or bottom for 3 or 4 pole circuit breakers. Standard connection with all NZM2, PN2 and N2 circuit breakers. Conversion kit for circuit breaker with box terminal. Use special cable lugs narrow version → 059775 Fitted within the switch housing.	Product Standards UL 489; CSA-C22.2 No. 5-09; IEC 60947; CE marking UL File No. E31593 UL CCN DIHS CSA File No. 022086 CSA Class No. 1432-01 NA Certification UL Listed, CSA certified Suitable for Refer to main component information
-		NZM2-4-XKS	266750	1 set	If a bar is used, insulation (400 mm) e.g. sleeving and a NZM2(-4)-XKSA cover are required. $U_e \geq 525$ V AC: With all other connection materials, e.g. cables and strips, use cover NZM2(-4)-XKSA.	-

# 4.2

## Compact circuit breakers, switch disconnectors



### Terminals NZM2

	Max. cable connection area	Number of poles	For use with	Terminal capacity			Terminal capacity	
				Cable lugs	Terminal capacity mm <sup>2</sup>	AWG/kcmil	Copper strip No. of discs x width x disc thickness mm	Copper bar Width x thickness mm
<b>Tunnel terminal</b>								
sg07815 Symbolphoto 		3 pole	NZM2, PN2, N(S)2	Copper cable ☉▽ 6 x 2.5 - 35 Aluminium cable plugs ☉▽	6 x 14 - 2	-	-	
								
1230PIC-683 Symbolphoto 			NZM2, PN2, N(S)2	Copper cable ☉▽ 1 x 16 - 185 Aluminium cable ☉▽ Up to 240 mm <sup>2</sup> can be connected depending on the cable manufacturer	1 x 6 - 350 1 x 16 - 185	-	-	
sg07915 Symbolphoto 		4 pole		Copper cable ☉▽ 6 x 2.5 - 35 Aluminium cable ☉▽	6 x 14 - 2	-	-	
1230PIC-676 Symbolphoto 			NZM2-4, PN2-4, N2-4	Copper cable ☉▽ 1 x 16 - 185 Aluminium cable ☉▽ Up to 240 mm <sup>2</sup> can be connected depending on the cable manufacturer	1 x 6 - 350	-	-	
<b>Rear terminal bolts</b>								
Not UL/CSA approved When using cable lugs without NZM3(-4)-XKSA cover, they must be insulated.								
1230PIC-1378 Symbolphoto 	-	3 pole	NZM2, PN2, N(S)2	Copper cable lugs 1 x 10 - 185 2 x 4 - 70 Aluminium cable lugs 1 x 10 - 50 2 x 10 - 50	-		≧ 2 x 16 x 0.8 ≧ 6 x 24 x 0.5	≧ 16 x 5 ≧ 20 x 5
1230PIC-1376 Symbolphoto 		4 pole	NZM2-4, PN2-4, N2-4	Copper cable lugs 1 x 10 - 185 2 x 4 - 70 Aluminium cable lugs 1 x 10 - 50 2 x 10 - 50	-		≧ 2 x 16 x 0.8 ≧ 6 x 24 x 0.5	≧ 16 x 5 ≧ 20 x 5
<b>Control cable terminals</b>								
1230PIC-729 Symbolphoto 	3 and 4 pole	NZM2(-4), PN2(-4), N(S)2(-4)	Screw terminals	1 x 0.75 - 2.5 2 x 0.75 - 1.5	1 x 18 - 14 2 x 18 - 16	-		
1230PIC-747 Symbolphoto 	3 and 4 pole	NZM2(-4), PN2(-4), N(S)2(-4)	Box terminal	1 x 0.75 - 2.5 2 x 0.75 - 1.5	1 x 18 - 14 2 x 18 - 16	-		

Part no. Article no. Std. pack Notes Information relevant for export to North America

Article no.  
when ordered separately







NZM2-XKAM	144113	1 set	  Contains parts for a terminal located at top or bottom for 3 or 4 pole switches. With control circuit terminal for 1 x 0.75 - 2.5 mm <sup>2</sup> (18 - 14 AWG) or 2 x 0.75 - 1.5 mm <sup>2</sup> (18 - 16 AWG) copper conductor. Flush mounting outside the switch housing. Use ferrules with flexible and highly flexible conductors. Max. cross section shown can only be connected when flexible and without ferrules Cover NZM2(-4)-XKSA must be fitted (included as standard).	Product Standards UL 489; CSA-C22.2 No. 5-09; IEC 60947; CE marking UL File No. E31593 UL CCN DIHS CSA File No. 022086 CSA Class No. 1437-01 NA Certification UL Listed, CSA certified Suitable for Refer to main component information
NZM1-XKA	266730			

NZM2-4-XKAM	144115	1 set		
-------------	--------	-------	--	--

NZM2-4-XKA	271458			
------------	--------	--	--	--

+NZM2-XKRO	266763	NZM2-XKR	266765	1 set	Part no. suffix and part no. contain parts for a circuit breaker side at top or bottom for 3 or 4 pole switches. O = for fitting at the top U = for fitting at the bottom
+NZM2-XKRU	266764	-			



+NZM2-4-XKRO	266766	NZM2-4-XKR	266768	
+NZM2-4-XKRU	266767	-		

NZM2-XSTS	260156	1 set	  Contains parts for two terminal locations located at top or bottom for 3 or 4 pole switches. Included as standard with tunnel terminal Degree of protection IP1X NZM-XSTK cannot be combined with IP2X protection against contact with a finger and NZM1(-4)-XIPK. Height or thickness of connections:	Product Standards UL 489; CSA-C22.2 No. 5-09; IEC 60947; CE marking UL File No. E140305 UL CCN DIHS CSA File No. 022086 CSA Class No. 1437-01 NA Certification UL Listed, CSA certified Suitable for Refer to main component information
NZM-XSTK	266739	1 set	  NZM-XSTK = 2 mm NZM-XSTS = 2 mm	

# 4.2

## Compact circuit breakers, switch disconnectors

### Terminals NZM2

	Number of poles	For use with	Terminal capacity			Part no. suffix	Article no.
			Connection	Terminal capacity mm <sup>2</sup>	AWG/kcmil		
<b>Cable lug cover</b>							
 <p>1230PIC-694 Symbolphoto</p>	3 pole	NZM2, PN2, N(S)2	Copper cable lugs Aluminium cable lugs	1 x 10-185 2 x 4-70 1 x 10-50 2 x 10-50	-	-	
 <p>1230PIC-688 Symbolphoto</p>	4 pole	NZM2-4, PN2-4, N2-4	Copper cable lugs Aluminium cable lugs	1 x 10-185 2 x 4-70 1 x 10-50 2 x 10-50	-	-	
<b>Cover</b>							
 <p>1230PIC-686 Symbolphoto</p>	3 pole	NZM2, PN2, N(S)2	-	-	-	-	
 <p>wa_sg07018 Symbolphoto</p>	4 pole	NZM2-4, PN2-4, N2-4	-	-	-	-	
<b>Phase isolators</b>							
 <p>sg08915 Symbolphoto</p>	3 pole	NZM2, PN2, N(S)2	-	-	-	-	
 <p>sg09015 Symbolphoto</p>	4 pole	NZM2-4, PN2-4, N2-4	-	-	-	-	
<b>Terminal covers, knockout</b>							
 <p>1230PIC-695 Symbolphoto</p>	3 pole	NZM2, PN2, N(S)2	-	-	-	+NZM2-XKSFAO +NZM2-XKSFAU	108269 108270
 <p>1230PIC-689 Symbolphoto</p>	4 pole	NZM2-4, PN2-4, N2-4	-	-	-	+NZM2-4-XKSFAO +NZM2-4-XKSFAU	108271 108272



Part no. Article no. Std. pack Notes Information relevant for export to North America

Article no.  
when ordered separately



Part no.	Article no.	Std. pack	Notes	Information relevant for export to North America
NZM2-XKSAE	119868	1 set 	Contains parts for a terminal located at top or bottom for 3 or 4 pole switches. Contact protection where cable lugs are used on screw terminals. When using insulated conductor material, degree of protection IP2X.	UL/CSA certification not required
NZM2-4-XKSAE	119870	1 set		-
NZM2-XKSA	260038	1 Off 	Contains parts for a terminal located at top or bottom for 3 or 4 pole switches Contact protection where cable lugs, bars or tunnel terminals are used. Included in set with tunnel terminals. When using insulated conductor material, degree of protection IP1X	Product Standards UL 489; CSA-C22.2 No. 5-09; IEC 60947; CE marking UL File No. E140305 UL CCN DIHS CSA File No. 022086 CSA Class No. 1432-01 NA Certification UL Listed, CSA certified Suitable for Refer to main component information
NZM2-4-XKSA	266770	1 Off		-
NZM2-XKP	119864	1 set 	Contains parts, including insulating plate for mounting plate, for a terminal located at top or bottom for 3 or 4 pole circuit breakers. Can not be combined with connection on rear NZM1/2(-4)-XKR. Insulation protection up to a rated operating voltage $U_o$ of 415V AC when minimum distances are not maintained.	UL/CSA certification not required
NZM2-4-XKP	119865	1 set		-
NZM2-XKSFA	104640	1 set 	Contains parts for a terminal located at top or bottom for 3 pole switches. Enhanced contact protection (simplified finger protection).	UL/CSA certification not required
NZM2-4-XKSFA	104641	1 Off		-

# 4.2

## Compact circuit breakers, switch disconnectors

### Terminals NZM2

Number of poles	For use with	Terminal capacity			Part no. suffix	Article no.
		Connection	Terminal capacity mm <sup>2</sup>	AWG/kcmil		

#### IP2X Protection against contact with finger

For box terminal

1230PIC-1377 Symbolphoto



3 pole

NZM2,  
PN2,  
N(S)2

-

-

-

-

1230PIC-675 Symbolphoto



4 pole

NZM2-4,  
PN2-4,  
N2-4

-

-

-

-

For covers NZM2(-4)-XKSA or NZM2(-4) or NZM2...(C)NA and N(S)2...NA

1230PIC-1367 Symbolphoto

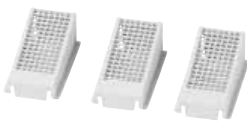

3 pole

NZM2,  
PN2,  
N(S)2

-

-

-

-

1230PIC-1375 Symbolphoto



4 pole

NZM2-4,  
PN2-4,  
N2-4

-

-

-

-

#### Copper cable lug

Not UL/CSA approved

When using cable lugs without NZM3(-4)-XKSA cover, they must be insulated.

1230PIC-693 Symbolphoto



3 and 4 pole

NZM2(-4),  
PN2(-4),  
N2(-4)

-

150 mm<sup>2</sup>

-

-

-

120 mm<sup>2</sup>

-

-

-

95 mm<sup>2</sup>

-

-

-

185 mm<sup>2</sup>

-

-

#### Mounting adapter plate

1230PIC-316 Symbolphoto



3 pole

NZM2  
PN2  
N2

-

-

-

-

Part no.	Article no.	Std. pack	Notes	Information relevant for export to North America
Article no. when ordered separately				

NZM2-XIPK	266773	1 set 	Contains parts for a terminal located at top or bottom for 3 switches. Enhanced contact protection to IP2X. Protection on grasping terminal chamber when connecting cables in box terminals. With two conductors maximum cross-section 25 mm <sup>2</sup> or AWG4.	UL/CSA certification not required
NZM2-4-XIPK	266774	1 set	Can not be combined with control cable terminal NZM-XSTK.	-

NZM2-XIPA	266777	1 set 	Contains parts for a terminal located at top or bottom for 3 switches. Enhanced contact protection to IP2X. When fitting to NZM2-...(C)NA or NZM...-NA: With 2 conductors maximum cross-section 25 mm <sup>2</sup> or AWG4.	UL/CSA certification not required
NZM2-4-XIPA	266778	1 set		-

KS150-NZM7	059777	3 Off	In order to crimp cable lugs when using stranded conductors, e.g., VDE 0295 Class 2 and rounded stranded sector-shaped conductors, you will need a Klauke K22, HK60/22, or EK22 crimping tool with the following crimping dies: R22/95 for 95 mm <sup>2</sup> R22/120 for 120 mm <sup>2</sup> R22/150 for 150 mm <sup>2</sup> R22/185 for 185 mm <sup>2</sup> R22/240 for 240 mm <sup>2</sup> R22/300 for 300 mm <sup>2</sup> Flexible conductors are adequate to a limited extent. They must be indent-crimped with a Klauke series 13 or series 25 crimping die.	-
KS120-NZM7	059776			
KS95-NZM7	059775			
NZM2-XKS185	260032			

NZM2-XAP7	119381	1 set	The replacement device can be positioned identically either with the connection side or the actuation shaft. NZM7 door coupling rotary handle can continue to be used if there is a minimum dimension of 213 mm between the mounting plate and the inside of the door. Otherwise, use new handle NZM2-XTVD...-0 with the new shaft.	UL/CSA certification not required
-----------	--------	-------	---	-----------------------------------

# 4.3

## Compact circuit breakers, switch disconnectors

### Terminals NZM3

Max. cable connection area	Number of poles	For use with	Rated current $I_n$	Terminal capacity			Terminal capacity	
				Cable	Terminal capacity	AWG/kcmil	Copper strip No. of discs x width x disc thickness mm	Copper bar Width x thickness mm

A

mm<sup>2</sup>

mm

mm

#### Box terminal

T230PIC-725 Symbolphoto

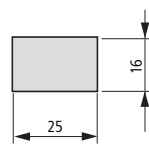

3 pole	NZM3(-4), PN3(-4), N(S)3(-4)	max. 500 400 UL/ CSA	Copper cable	1 x 35 - 240	1 x 2 - 350	min. 6 x 16 x 0.8	-
			Copper cable	2 x 16 - 120		max. 10 x 24 x 1.0 oder max. 11 x 21 x 1	
		630	Copper cable	1 x 35 - 240 2 x 16 - 120	1 x 2 - 350	10 x 24 x 1.0 + 5 x 24 x 1.0 oder (2 x) 8 x 24 x 1.0	-

T230PIC-721 Symbolphoto



4 pole	NZM3(-4), PN3(-4), N(S)3(-4)	max. 500 400 UL/ CSA	Copper cable	1 x 35 - 240	1 x 2 - 350	min. 6 x 16 x 0.8	-
			Copper cable	2 x 16 - 120		max. 10 x 24 x 1.0 oder max. 11 x 21 x 1	
		630	Copper cable			10 x 24 x 1.0 + 5 x 24 x 1.0 oder (2 x) 8 x 24 x 1.0	-

#### Screw connection Standard

T230PIC-731 Symbolphoto

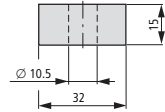



3 pole	NZM3, PN3, N(S)3	630	Copper cable	1 x 16 - 300	1 x 4 - 350	10 x 32 x 1.0	30 x 10
			lugs	2 x 16 - 240	2 x 350	+ 5 x 32 x 130	+ 30 x 5
		max. 400	Aluminium cable	1 x 10 - 120 2 x 10 - 120	1 x 4 - 350 2 x 350		

T230PIC-731 Symbolphoto



4 pole	NZM3-4, PN3-4, N(S)3-4	630	Copper cable	1 x 16 - 300	1 x 4 - 350	10 x 32 x 1.0	30 x 10
			lugs	2 x 16 - 240	2 x 350	+ 5 x 32 x 1.0	+ 30 x 5
		max. 400	Aluminium cable	1 x 10 - 120 2 x 10 - 120	1 x 4 - 350 2 x 350		

Part no. suffix	Article no.	Part no.	Article no.	Std. pack	Notes	Information relevant for export to North America
Article no. for ordering with basic device		Article no. when ordering separately				
+NZM3-XKCO	262246	-		1 set	Part no. suffix and part no. contain parts for a circuit breaker side at top or bottom for 3 or 4 pole switches. Conversion kit for circuit breaker with screw terminal. Fitted within the switch housing O = for fitting at the top U = for fitting at the bottom $U_0 \geq 525$ V AC: Use NZM3(-4)-XKSA cover.	Product Standards UL 489; CSA-C22.2 No. 5-09; IEC 60947; CE marking UL File No. E31593 UL CCN DIHS CSA File No. 022086 CSA Class No. 1437-01 NA Certification UL Listed, CSA certified Suitable for Refer to main component information
+NZM3-XKCU	262245	-				
-		NZM3-XKC	260042			
+NZM3-4-XKCU	266782	-		1 set	Use ferrules with flexible and highly flexible conductors. Observe limited cable cross-section through sleeve.	-
+NZM3-4-XKCO	266781	NZM3-4-XKC	266783			
-		NZM3-XKS	260039	1 set	Contains parts for a terminal located at top or bottom for 3 or 4 pole switches. Standard connection with all NZM3, PN3 and N3 circuit breakers. Conversion kit for circuit breaker with box terminal. Use special cable lugs narrow version, → 059775 Fitted within the switch housing. If a bar is used, insulation (400 mm) heat-shrink tubing and a cover NZM3(-4)-XKSA are required. $U_0 \geq 525$ V AC: For all other connection types use cover NZM3(-4)-XKSA.	Product Standards UL 489; CSA-C22.2 No. 5-09; IEC 60947; CE marking UL File No. E31593 UL CCN DIHS CSA File No. 022086 CSA Class No. 1437-01 NA Certification UL Listed, CSA certified Suitable for Refer to main component information
-		NZM3-4-XKS	266780	1 set		

# 4.3





## Compact circuit breakers, switch disconnectors

### Terminals NZM3

Max. cable connection area	Number of poles	For use with	Rated current $I_n$	Terminal capacity			Terminal capacity	
				Cable lugs	Terminal capacity	AWG/kcmil	Copper strip No. of discs x width x disc thickness mm	Copper bar Width x thickness mm
			A		mm <sup>2</sup>			

#### Connection width extension

One hole, for screws or terminals

 <p>1230PIC-773 Symbolphoto</p>	3 pole	NZM3, PN3, N(S)3	630	Copper cable lugs	2 x 300	2 x 500	2 x 10 x 50 x 1.0	(2 x) 10 x 50
 <p>1230PIC-772 Symbolphoto</p>	4 pole	NZM3-4, PN3-4, N3-4	630	Copper cable lugs	2 x 300	2 x 500	2 x 10 x 50 x 1.0	(2 x) 10 x 50
 <p>1230PIC-774 Symbolphoto</p>	3 pole	NZM3, PN3, N(S)3	630	Copper cable lugs	NZM3-XKV70-2: 4 x 35 - 185 NZM3-XKV70-2 + NZM4-XKA: 4 x 50 - 240	NZM3-XKV70-2: 2 x 350 NZM3-XKV70-2 + NZM4-XKA: 4 x 500	NZM3-XKV70-2 + NZM4-XKB: ≅ 6 x 16 - 0.8 ≅ (2 x) 10 x 32 x 1	(2 x) 10 x 50
 <p>1230PIC-775 Symbolphoto</p>	4 pole	NZM3-4, PN3-4, N(S)3-4	630	Copper cable lugs	2 x 300	2 x 500	(2 x) 10 x 50 x 1.0	(2 x) 10 x 50
 <p>1230PIC-776 Symbolphoto</p>	3 pole	NZM3, PN3, N(S)3	630	Copper cable lugs	2 x 95 - 300	2 x 500	(2x) 10 x 32 x 1.0	(2 x) 10 x 40

## Terminals NZM3

Part no. suffix	Article no.	Part no.	Article no.	Std. pack	Notes	Information relevant for export to North America
Article no. for ordering with basic device		Article no. when ordering separately				
-		NZM3-XKV70	100514	1 set	<p>Contains parts for a terminal located at top or bottom for 3 or 4 pole switches. Central drilling for e.g. up to 2 cable lugs per phase. For fitting to switches with screw terminal. Phase isolator and insulation plate are included as standard. Distance between pole centres with NZM3(-4)-XKV70: 70 mm.</p>	<p>Product Standards UL 489; CSA-C22.2 No. 5-09; IEC 60947; CE marking</p> <p>UL File No. E140305</p> <p>UL CCN DIHS</p> <p>CSA File No. 022086</p> <p>CSA Class No. 1432-01</p> <p>NA Certification UL Listed, CSA certified</p>
-		NZM3-4-XKV70	100515	1 set	<p>Hole for control wire exists. Connection terminals NZM3(-4)-XK300 and NZM3(-4)-XK22X21 can be installed</p>	-
-		NZM3-XKV70-2	119860	1 set	<p>Contains parts for a terminal located at top or bottom for 3 pole circuit breakers. Double hole fitting for up to four 185 mm<sup>2</sup> cable lugs, 50 mm bar or large flat cable terminal NZM4-XKB or large tunnel terminal NZM4-XKA. For fitting to switches with screw terminal. Phase isolator, insulation plate and 2 control circuit terminals supplied.</p>	<p>Product Standards UL 489; CSA-C22.2 No. 5-09; IEC 60947; CE marking</p> <p>NA Certification Request filed for UL and CSA</p> <p>Suitable for Refer to main component information</p>
-		NZM3-4-XKV70-2	132673	1 set	<p>Contains parts for a terminal located at top or bottom for 3 pole circuit breakers. Double hole fitting for up to four 185 mm<sup>2</sup> cable lugs, 50 mm bar or large flat cable terminal NZM4-XKB or large tunnel terminal NZM4-XKA. For fitting to switches with screw terminal. Phase isolator, insulation plate and 2 control circuit terminals supplied.</p>	-
-		NZM3-XKV70KB	112884	1 set	<p>Contains parts for a terminal located at top or bottom for 3 pole circuit breakers. Threaded stud for cable lugs up to 2 × 300mm<sup>2</sup>. For fitting to switches with screw terminal. Phase isolator, insulation plate and 2 control circuit terminals supplied</p>	<p>Product Standards UL 489; CSA-C22.2 No. 5-09; IEC 60947; CE marking</p> <p>NA Certification Request filed for UL and CSA</p> <p>Suitable for Refer to main component information</p>

# 4.3

## Compact circuit breakers, switch disconnectors

### Terminals NZM3

Max. cable connection area	Number of poles	For use with	Rated current $I_n$	Terminal capacity			Terminal capacity	
				Cable Cable lugs	Terminal capacity	AWG/kcmil	Copper strip No. of discs x width x disc thickness mm	Copper bar Width x thickness mm
			A		mm <sup>2</sup>			

#### Terminals for connection width extension



3 pole	NZM3, PN3, N(S)3	max. 500	Copper cable	1 x 120 - 300 -	-	-
--------	------------------	----------	--------------	-----------------	---	---

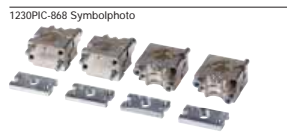

4 pole	NZM3-4, PN3-4, N3-4	max. 500	Copper cable	1 x 120 - 300 -	-	-
--------	---------------------	----------	--------------	-----------------	---	---

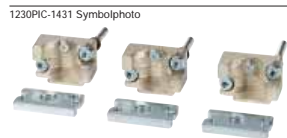

3 pole	NZM3, PN3, N(S)3	630	-	-	-	(2 x) 11 x 21 x 1.0 -
--------	------------------	-----	---	---	---	-----------------------



4 pole	NZM3-4, PN3-4, N3-4	630	-	-	-	(2 x) 11 x 21 x 1.0 -
--------	---------------------	-----	---	---	---	-----------------------

#### Tunnel terminal

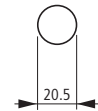

3 pole	NZM3, PN3, N(S)3	max. 350	Copper cable ⊙ ▽ Aluminium cable ⊙ ▽	1 x 16 - 185	1 x 6 - 350	-
--------	------------------	----------	---	--------------	-------------	---



4 pole	NZM3-4, PN3-4, N3-4	max. 350	Copper cable ⊙ ▽ Aluminium cable ⊙ ▽	1 x 16 - 185	1 x 6 - 350	-
--------	---------------------	----------	---	--------------	-------------	---

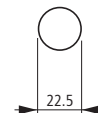

3 pole	NZM3, PN3, N(S)3	max. 630	Copper cable ⊙ ▽ Aluminium cable ⊙ ▽	1 x 50 - 240 2 x 50 - 240	1 x 0 - 500 2 x 0 - 500	-
--------	------------------	----------	---	------------------------------	----------------------------	---



4 pole	NZM3-4, PN3-4, N3-4	max. 630	Copper cable ⊙ ▽ Aluminium cable ⊙ ▽	1 x 50 - 240 2 x 50 - 240	1 x 0 - 500 2 x 0 - 500	-
--------	---------------------	----------	---	------------------------------	----------------------------	---







## Terminals NZM3



Part no. suffix	Article no.	Part no.	Article no.	Std. pack	Notes	Information relevant for export to North America
Article no. for ordering with basic device		Article no. when ordering separately				
-		NZM3-XK300	100782	1 set	Contains parts for a terminal located at top or bottom for 3 or 4 pole switches. Only in combination with connection width extension NZM3(-4)-XKV70. Use ferrules with flexible and highly flexible conductors. With control cable terminal for 1 x 0.75 - 2.5 mm <sup>2</sup> or 2 x 0.75 - 1.5 mm <sup>2</sup> copper conductor.	Product Standards UL 489; CSA-C22.2 No. 5-09; IEC 60947; CE marking UL File No. E31593 UL CCN DIHS CSA File No. 022086 CSA Class No. 1432-01 NA Certification UL Listed, CSA certified Suitable for Refer to main component information
-		NZM3-4-XK300	100783	1 set		-
-		NZM3-XK22X21	100784	1 set	Contains parts for a terminal located at top or bottom for 3 or 4 pole switches. Only in combination with connection width extension NZM3(-4)-XKV70. Use ferrules with flexible and highly flexible conductors. With control cable terminal for 1 x 0.75 - 2.5 mm <sup>2</sup> or 2 x 0.75 - 1.5 mm <sup>2</sup> copper conductor.	Not UL/CSA approved
-		NZM3-4-XK22X21	100785	1 set		Not UL/CSA approved
-		NZM3-XKA1	271459	1 set	Contains parts for a terminal located at top or bottom for 3 or 4 pole circuit breakers. With control cable terminal for 1 x 0.75 - 2.5 mm <sup>2</sup> (18 - 14 AWG) or 2 x 0.75 - 1.5 mm <sup>2</sup> (18 - 16 AWG) copper conductor.	-
-		NZM3-4-XKA1	271460	1 set	Fitting outside switch housing. Use ferrules with flexible and highly flexible conductors. Max. cross section shown can only be connected when flexible and without ferrules. Cover NZM3(-4)-XKSA must be fitted (included as standard).	-
-		NZM3-XKA2	271461	1 set	Contains parts for a terminal located at top or bottom for 3 or 4 pole circuit breakers. With control cable terminal for 1 x 0.75 - 2.5 mm <sup>2</sup> (18 - 14 AWG) or 2 x 0.75 - 1.5 mm <sup>2</sup> (18 - 16 AWG) copper conductor. Fitting outside switch housing. Use ferrules with flexible and highly flexible conductors. Max. cross section shown can only be connected when flexible and without ferrules. Cover NZM3(-4)-XKSA must be fitted (included as standard).	Product Standards UL 489; CSA-C22.2 No. 5-09; IEC 60947; CE marking UL File No. E31593 UL CCN DIHS CSA File No. 022086 CSA Class No. 1432-01 NA Certification UL Listed, CSA certified Suitable for Refer to main component information
-		NZM3-4-XKA2	271462	1 set		-

# 4.3

## Compact circuit breakers, switch disconnectors

### Terminals NZM3

	Max. cable connection area	Number of poles	For use with	Rated current $I_n$  A	Terminal capacity			Terminal capacity	
					Cable Cable lugs	Terminal capacity  mm <sup>2</sup>	AWG/kcmil	Copper strip No. of discs x width x disc thickness mm	Copper bar Width x thickness mm
<b>Rear terminal bolts</b>									
1230PIC-1385 Symbolphoto 	-	3 pole	NZM3, PN3, N3	max. 630  max. 500	Copper cable lugs Aluminium cable lugs	1 x 16 - 240 2 x 16 - 240  1 x 10 - 120 2 x 10 - 120	-	min. 6 x 16 x 0.8 max. 10 x 32 x 1.0	min. 20 x 5 max. 30 - 10
1230PIC-1380 Symbolphoto 	-	4 pole	NZM3-4, PN3-4, N3-4	max. 630  max. 500	Copper cable lugs Aluminium cable lugs	1 x 16 - 240 2 x 16 - 240  1 x 10 - 120 2 x 10 - 120	-	min. 6 x 16 x 0.8 max. 10 x 32 x 1.0	min. 20 x 5 max. 30 - 10
<b>Control cable terminals</b>									
1230PIC-729 Symbolphoto 	-	3 and 4 pole	NZM3, PN3, N(S)3	-	Screw terminals	1 x 0.75 - 2.5 2 x 0.75 - 1.5	1 x 18 - 14 2 x 18 - 16	-	-
1230PIC-747 Symbolphoto 	-	3 and 4 pole	NZM3-4, PN3, N(S)3-4	-	Box terminal	1 x 0.75 - 2.5 2 x 0.75 - 1.5	1 x 18 - 14 2 x 18 - 16	-	-



Part no. suffix	Article no.	Part no.	Article no.	Std. pack	Notes	Information relevant for export to North America
Article no. for ordering with basic device		Article no. when ordering separately				
+NZM3-XKRO	266790	NZM3-XKR	266792	1 set	Part no. suffix and part no. contain parts for a circuit breaker side at top or bottom for 3 or 4 pole switches. O = for fitting at the top U = for fitting at the bottom	Not UL/CSA approved
+NZM3-XKRU	266791	-				
+NZM3-4-XKRO	266793	NZM3-4-XKR	266795	1 set		Not UL/CSA approved
+NZM3-4-XKRU	266794	-				
-		NZM3/4-XSTS	266797	1 set	Contains for two terminal locations located at top or bottom for 3 or 4 pole circuit breakers. Included as standard with tunnel terminal. Degree of protection IP1X Height or thickness of connections NZM-XSTS = 2 mm	Product Standards: UL 489; CSA-C22.2 No. 5-09; IEC 60947; CE marking UL File No. E140305 UL CCN DIHS CSA File No. 022086 CSA Class No. 1437-01 NA Certification: UL Listed, CSA certified Suitable for: Refer to main component information
						
-		NZM-XSTK	266739	1 set	Contains for two terminal locations located at top or bottom for 3 or 4 pole circuit breakers. Included as standard with tunnel terminal. Degree of protection IP1X NZM-XSTK cannot be combined with NZM1(-4)-XIPK IP2X protection against contact with finger. Height or thickness of connections: NZM-XSTK = 2 mm NZM-XSTS = 2 mm	
						

# 4.3

## Compact circuit breakers, switch disconnectors

### Terminals NZM3









	Max. cable connection area	Number of poles	For use with	Part no.  Article no. when ordering separately	Article no.
<b>Cable lug cover</b>					
1230PIC-694 Symbolphoto 	-	3 pole	NZM3, PN3, N(S)3	NZM3-XKSAE	119869
1230PIC-688 Symbolphoto 	-	4 pole	NZM3-4, PN3-4, N3-4	NZM3-4-XKSAE	119871
<b>Cover</b>					
1230PIC-1352 Symbolphoto 	-	3 pole	NZM3(-4), PN3(-4), N(S)3(-4)	NZM3-XKSA	260045
1230PIC-1353 Symbolphoto 	-	4 pole	NZM3-4, PN3-4, N3-4	NZM3-4-XKSA	266801
<b>Phase isolators</b>					
sg08715 Symbolphoto 	-	3 pole	NZM3-4, PN3-4, N(S)3-4	NZM3-XKP	100512
sg08815 Symbolphoto 	-	4 pole	NZM3-4, PN3-4, N3-4	NZM3-4-XKP	100513

Std. pack	Notes	Information relevant for export to North America
1 set 	Contains parts for a terminal located at top or bottom for 3 or 4 pole switches. Contact protection where cable lugs are used on screw terminals. When using insulated conductor material, degree of protection IP2X.	UL/CSA certification not required
1 set		
1 Off 	Contains parts for a terminal located at top or bottom for 3 pole switches. Insulation/protection against direct contact where cable lugs, bars or tunnel terminals are used. Included in set with tunnel terminals. When using insulated conductor material to degree of protection IP1X.	Product Standards UL 489; CSA-C22.2 No. 5-09; IEC 60947; CE marking UL File No. E31593 UL CCN DIHS CSA File No. 022086 CSA Class No. 1437-01 NA Certification UL Listed, CSA certified Suitable for Refer to main component information
1 Off		
1 set 	Contains parts, including insulating plate for mounting plate, for a terminal located at top or bottom for 3 or 4 pole circuit breakers. Included with the connection width extension. Cannot be combined with the NZM3(-4)-XKA tunnel terminal, NZM3(-4)-XKR connection on rear. Insulation protection where cable lugs, bars, or flat conductor are used.	Product Standards UL 489; CSA-C22.2 No. 5-09; IEC 60947; CE marking UL File No. E31593 UL CCN DIHS CSA File No. 022086 CSA Class No. 1432-01 NA Certification UL Listed, CSA certified Suitable for Refer to main component information
1 set		

# 4.3

## Compact circuit breakers, switch disconnectors

### Terminals NZM3

	Max. cable connection area	Number of poles	For use with	Part no.	Article no.
				Article no. when ordering separately	
<b>Terminal covers, knockout</b>					
1230PIC-695 Symbolphoto 	-	3 pole	NZM3-4, PN3-4, N(S)3-4	NZM3-XKSFA	104642
1230PIC-689 Symbolphoto 	-	4 pole	NZM3-4, PN3-4, N3-4	NZM3-4-XKSFA	104643
<b>Large cover for connection width extension</b>					
1230PIC-699 Symbolphoto 	-	3 pole	NZM3, PN3, N3 + NZM3-XKV70(-2)	NZM3-XKSAV	119858
1230PIC-696 Symbolphoto 	-	4 pole	NZM3-4, PN3-4, N3-4 + NZM3-4-XKV70	NZM3-4-XKSAV	132675
<b>IP2X Protection against contact with finger</b>					
For box terminal					
1230PIC-1384 Symbolphoto 	-	3 pole	NZM3, PN3, N3	NZM3-XIPK	266804
1230PIC-675 Symbolphoto 	-	4 pole	NZM3-4, PN3-4, N3-4	NZM3-4-XIPK	266805
For covers NZM3(-4)-XKSA or NZM3...(C)NA and N(S)3...NA					
wa_sg07118 Symbolphoto 	-	3 pole	NZM3, PN3, N(S)3	NZM3-XIPA	266808
1230PIC-1379 Symbolphoto 	-	4 pole	NZM3-4, PN3-4, N3-4	NZM3-4-XIPA	266809

Part no. suffix	Article no.	Std. pack	Notes	Information relevant for export to North America
Article no. for ordering with basic device				

+NZM3-XKSFAO	108273	1 Off	Contains parts for a terminal located at top or bottom for 3 or 4 pole switches. Enhanced contact protection (simplified finger protection).	UL/CSA certification not required
+NZM3-XKSFAU	108274			

+NZM3-4-XKSFAO	108275	1 Off	-
+NZM3-4-XKSFAU	108276		

-		1 Off	Contains parts for a terminal located at top or bottom for 3 pole circuit breakers. Insulation protection/protection against direct contact for connection of cable lugs or bars to connection width extension. Can also be used for connection width extension NZM3-XKV70 or NZM3-XKV70-2 with terminals NZM3-XK300 or NZM3-XK22x21 or NZM4-XKA.	-
---	--	-------	---	---

-		1 Off	Cannot be combined with connection width NZM3-XKV70KB. When using insulated conductor material, degree of protection IP2X.	-
---	--	-------	--	---

-		1 set	Contains parts for a terminal located at top or bottom for 3 or 4 pole circuit breakers. Enhanced contact protection to IP2X. Protection when reaching into the cable connection area with the connection of cables in the box terminal. With 2 conductors max. cross section 70mm <sup>2</sup> .	UL/CSA certification not required
				

-		1 set	Cannot be combined with NZM-XSTK control circuit terminal.	-
---	--	-------	--	---



-		1 set	Contains parts for a terminal located at top or bottom for 3 or 4 pole switches. Enhanced contact protection to IP2X. When fitting to NZM3...(C)NA or N3...-NA: with 2 conductors max. cross section 70 mm <sup>2</sup> .	UL/CSA certification not required
				

-		1 set	-
---	--	-------	---

# 4.3

## Compact circuit breakers, switch disconnectors

### Terminals NZM3

	Max. cable connection area	Number of poles	For use with	Part no.	Article no.
				Article no. when ordering separately	
<b>Copper cable lug</b>					
Not UL/CSA approved					
When using cable lugs without NZM3(-4)-XKSA cover, they must be insulated.					
 1230PIC-693 Symbolphoto	185 mm <sup>2</sup>	-	3 and 4 pole	NZM3(-4), PN3(-4), N3(-4)	NZM3-XKS185 260040
	240 mm <sup>2</sup>				NZM3-XKS240 260041
	300 mm <sup>2</sup>			NZM3(-4), PN3(-4), N3(-4), NZM4(-4), N(-4)	NZM3-XKS300 153186
<b>Mounting adapter plate</b>					
 1230PIC-317 Symbolphoto	-	-	3 pole	NZM3 PN3 N3	NZM3-XAP10 119382



Std. pack

Notes

Information relevant for export to North America



3 Off	<p>In order to crimp cable lugs when using stranded conductors, e.g., VDE 0295 Class 2 and rounded stranded sector-shaped conductors, you will need a Klauke K22, HK60/22, or EK22 crimping tool with the following crimping dies:</p> <ul style="list-style-type: none"> <li>• R22/95 for 95 mm<sup>2</sup></li> <li>• R22/120 for 120 mm<sup>2</sup></li> <li>• R22/150 for 150 mm<sup>2</sup></li> <li>• R22/185 for 185 mm<sup>2</sup></li> <li>• R22/240 for 240 mm<sup>2</sup></li> <li>• R22/300 for 300 mm<sup>2</sup></li> </ul> <p>Flexible conductors are adequate to a limited extent. They must be indent-crimped with a Klauke series 13 or series 25 crimping die.</p>	-
1 set	<p>The replacement device can be positioned identically either with the connection side or the actuation shaft.</p> <p>The NZM10 door coupling rotary handle can continue to be used if the shaft has a thickness of 12 mm. Otherwise, use new handle NZM3 with the new shaft.</p>	UL/CSA certification not required

# 4.4

## Compact circuit breakers, switch disconnectors

### Terminals NZM4

Space requirement	Number of poles	For use with	Rated current <sup>1)</sup> $I_n$	Terminal capacity			Terminal capacity	
				Cable Cable lugs	Terminal capacity	AWG/kcmil	Copper strip No. of discs x width x disc thickness mm	Copper bar Width x thickness mm
			A		mm <sup>2</sup>			

#### Screw terminals

Threaded stud standard equipment

##### Screws

1230PIC-731 Symbolphoto



Space requirement	Number of poles	For use with	Rated current <sup>1)</sup>	Terminal capacity	Terminal capacity	Terminal capacity	Terminal capacity	
2-hole	3 pole	NZM4, N(S)4	max. 1600	Copper cable- lugs	1 x 120 - 185 4 x 50 - 185	1 x 250 - 350 4 x 0 - 350	(2 x) 10 x 50 x 1.0	(2 x) 50 x 10
2-hole	4 pole	NZM4-4, N4-4	max. 1600	Copper cable- lugs	1 x 120 - 185 4 x 50 - 185	1 x 250 - 350 4 x 0 - 350	(2 x) 10 x 50 x 1.0	(2 x) 50 x 10

Part no.      Article no.      Std. pack      Notes

Information relevant for export to North America

Article no. when  
ordering separately



---

NZM4-XKS	127736	1 set	 Double hole fitting with M10 threaded stud at 25 mm spacing. Use special cable lug narrow version. M10x50 socket cap screw + M10x40 socket cap screw + self locking nut.	UL/CSA certification not required
----------	--------	-------	--	-----------------------------------

---

NZM4-4-XKS	127737	1 set	-	-
------------	--------	-------	---	---

# 4.4

## Compact circuit breakers, switch disconnectors

### Terminals NZM4

	Space requirement	Number of poles	For use with	Rated current <sup>1)</sup> $I_n$  A	Terminal capacity			Terminal capacity	
					Cable lugs Cable lugs	Terminal capacity mm <sup>2</sup>	AWG/kcmil	Copper strip No. of discs x width x disc thickness mm	Copper bar Width x thickness mm
<b>Module plate</b>									
1230PIC-744 Symbolphoto 	1-hole	3 pole	NZM4, N(S)4	max. 1250	Copper cable- lugs 1 x 120 - 300 2 x 95 - 300	1 x 250 - 600 2 x 000 - 600	(2 x) 10 x 40 x 1.0 (2 x) 10 x 50 x 1.0	(2 x) 40 x 10 (2 x) 50 x 10	
1230PIC-742 Symbolphoto 	1-hole	4 pole	NZM4-4, N4-4	max. 1250	Copper cable- lugs 1 x 120 - 300 2 x 95 - 300	1 x 250 - 600 2 x 000 - 600	(2 x) 10 x 40 x 1.0 (2 x) 10 x 50 x 1.0	(2 x) 40 x 10 (2 x) 50 x 10	
1230PIC-1407 Symbolphoto 	2-hole	3 pole	NZM4, N(S)4	max. 1400	Copper cable- lugs 2 x 95 - 185 4 x 35 - 185	2 x 000 - 350 4 x 2 - 350	(2 x) 10 x 50 x 1.0	(2 x) 10 x 50 x 1.0	
1230PIC-870 Symbolphoto 	2-hole	4 pole	NZM4-4, N4-4	max. 1400	Copper cable- lugs 2 x 95 - 185 4 x 35 - 185	2 x 000 - 350 4 x 2 - 350	(2 x) 10 x 50 x 1.0	(2 x) 10 x 50 x 1.0	
1230PIC-1408 Symbolphoto 	2-hole	3 pole	NZM4, N(S)4	max. 1250	Copper cable- lugs 2 x 95 - 300	2 x 000 - 600	(2 x) 10 x 40 x 1.0 (2 x) 10 x 50 x 1.0	(2 x) 40 x 10 (2 x) 50 x 10	
sg08515 Symbolphoto 	2-hole	4 pole	NZM4-4, N4-4	max. 1250	Copper cable- lugs 2 x 95 - 300	2 x 000 - 600	(2 x) 10 x 40 x 1.0 (2 x) 10 x 50 x 1.0	(2 x) 40 x 10 (2 x) 50 x 10	
1230PIC-1408 Symbolphoto 	2-hole	3 pole	NZM4, N(S)4	max. 1600	Copper cable- lugs 2 x 95 - 300	2 x 000 - 600	(2 x) 10 x 40 x 1.0 (2 x) 10 x 50 x 1.0	(2 x) 40 x 10 (2 x) 50 x 10	
1230PIC-871 Symbolphoto 	2-hole	4 pole	NZM4-4, N4-4	max. 1600	Copper cable- lugs 2 x 95 - 300	2 x 000 - 600	(2 x) 10 x 40 x 1.0 (2 x) 10 x 50 x 1.0	(2 x) 40 x 10 (2 x) 50 x 10	

Part no. Article no. Std. pack Notes

Information relevant for export to North America

Article no. when ordering separately



Part no.	Article no.	Std. pack	Notes	Product Standards
NZM4-XKM1	266814	1 set	<p>Contains parts for a terminal located at top or bottom for 3 or 4 pole switches. For M10 screws. Can be enlarged for M12 screws. Use special cable lug narrow version. Can be fitted to circuit breaker with screw terminal. Insulation using cover NZM4(-4)-XKSA or phase divider NZM4(-4)-XKP necessary.</p>	<p>UL489; CSA-C22.2 No. 5-09; IEC60947, CE marking UL File No. E31593 UL CCN DIHS CSA File No. 22086 CSA Class No. 1432-01 NA Certification UL listed, CSA certified Suitable for Refer to main component information</p>
NZM4-4-XKM1	266815	1 set	-	-
NZM4-XKM2	266820	1 set	<p>Contains parts for a terminal located at top or bottom for 3 or 4 pole switches. For M10 screws. Can be enlarged for M12 screws. Use special cable lug narrow version. Can be fitted to circuit breaker with screw terminal. Insulation using cover NZM4(-4)-XKSA or phase divider NZM4(-4)-XKP necessary.</p>	<p>UL489; CSA-C22.2 No. 5-09; IEC60947, CE marking UL File No. E31593 UL CCN DIHS CSA File No. 22086 CSA Class No. 1432-01 NA Certification UL listed, CSA certified Suitable for Refer to main component information</p>
NZM4-4-XKM2	266821	1 set	-	-
NZM4-XKM2S-1250	284471	1 set	<p>Contains parts for a terminal located at top or bottom for 3 or 4 pole circuit breakers. Insulation using cover NZM4(-4)-XKSA or phase divider NZM4(-4)-XKP necessary.</p>	<p>UL489; CSA-C22.2 No. 5-09; IEC60947, CE marking UL File No. E31593 UL CCN DIHS CSA File No. 22086 CSA Class No. 1432-01 NA Certification UL listed, CSA certified Suitable for Refer to main component information</p>
NZM4-4-XKM2S-1250	284472	1 set	-	-
NZM4-XKM2S-1600	284473	1 set	<p>Contains parts for a terminal located at top or bottom for 3 or 4 pole circuit breakers. Insulation using cover NZM4(-4)-XKSA or phase divider NZM4(-4)-XKP necessary.</p>	<p>UL489; CSA-C22.2 No. 5-09; IEC60947, CE marking UL File No. E31593 UL CCN DIHS CSA File No. 22086 CSA Class No. 1432-01 NA Certification UL listed, CSA certified Suitable for Refer to main component information</p>
NZM4-4-XKM2S-1600	284474	1 set	-	-

# 4.4

## Compact circuit breakers, switch disconnectors

### Terminals NZM4

	Number of poles	For use with	Rated current <sup>1)</sup> $I_n$  A	Terminal capacity			Terminal capacity	
				Cable Cable lugs	Terminal capacity  mm <sup>2</sup>	AWG/kcmil	Copper strip No. of discs x width x disc thickness mm	Copper bar Width x thickness mm
<b>Flat cable terminal</b>								
1230PIC-700 Symbolphoto 	3 pole	NZM4, N(S)4	max. 1100	-	-	-	min. 6 x 16 x 0.8 max. (2 x) 10 x 32 x 1.0	-
	4 pole	NZM4-4, N4-4	max. 1100	-	-	-	min. 6 x 16 x 0.8 max. (2 x) 10 x 32 x 1.0	-
<b>Tunnel terminal</b>								
1230PIC-1438 Symbolphoto 	3 pole	NZM4, N(S)4	max. 1400	Copper cable ⊙▽ Aluminium cable ⊙▽	1 x 50 - 240 4 x 50 - 240	1 x 0 - 500 4 x 0 - 500	-	-
1230PIC-776 Symbolphoto 	4 pole	NZM4-4, N4-4	max. 1400	Copper cable ⊙▽ Aluminium cable ⊙▽	1 x 50 - 240 4 x 50 - 240	1 x 0 - 500 4 x 0 - 500	-	-
<b>Rear terminal bolts</b>								
1230PIC-701 Symbolphoto 	3 pole	NZM4, N4	max. 1250	Copper cable- lugs Aluminium cable lugs	1 x 120 - 185 2 x 95 - 185 4 x 35 - 185 1 x 185 2 x 70 - 185 4 x 50 - 185	-	(2 x ) 10 x 50 x 1.0	(2 x ) 50 x 10
	4 pole	NZM4(-4), N4(-4)	max. 1250	Copper cable- lugs Aluminium cable lugs	1 x 120 - 185 2 x 95 - 185 4 x 35 - 185 1 x 185 2 x 70 - 185 4 x 50 - 185	-	(2 x ) 10 x 50 x 1.0	(2 x ) 50 x 10

Part no.	Article no.	Std. pack	Notes	Information relevant for export to North America
Article no. when ordering separately				
NZM4-XKB	266829	1 set	<p>Contains parts for a terminal located at top or bottom for 3 or 4 pole switches.</p> <p>Conversion kit for circuit breaker with screw terminal. Insulation using cover NZM4(-4)-XKSA or phase divider NZM4(-4)-XKP necessary.</p> <p>When the circuit breaker is installed on a conductive mounting plate, cover NZM4(-4)-XKSA must be used</p>	<p>Product Standards CSA-C22.2 No. 5-09; IEC60947, CE marking</p> <p>NA Certification Request filed for CSA</p>
NZM4-4-XKB	266831	1 set	With control circuit terminal for 1 x 0.75 - 2.5 mm <sup>2</sup> or 2x 0.75 - 1.5 mm <sup>2</sup> copper conductors as standard.	-
NZM4-XKA	266836	1 set	<p>Contains parts for a terminal located at top or bottom for 3 or 4 pole switches.</p> <p>With control circuit terminal for 1 x 0.75 - 2.5 mm<sup>2</sup> (18 - 14 AWG) or 2 x 0.75 - 1.5 mm<sup>2</sup> (18 - 16 AWG) copper cable as standard.</p> <p>Can be fitted to circuit breaker with screw terminal. Use ferrules with flexible and highly flexible conductors. Cover NZM4(-4)-XKSA must be fitted</p>	<p>Product Standards UL489; CSA-C22.2 No. 5-09; IEC60947, CE marking</p> <p>UL File No. E31593</p> <p>UL CCN DIHS</p> <p>CSA File No. 22086</p> <p>CSA Class No. 1432-01</p> <p>NA Certification UL listed, CSA certified</p> <p>Suitable for Refer to main component information</p>
NZM4-4-XKA	266837	1 set	(included as standard).	-
NZM4-XKR	266842	1 set	<p>Contains parts for a terminal located at top or bottom for 3 or 4 pole switches.</p> <p>Can also be retrofitted: Module plate NZM4...-XKM... or connection width extension NZM4...-XKV...</p>	Not UL/CSA approved
NZM4-4-XKR	266843	1 set		Not UL/CSA approved

# 4.4

## Compact circuit breakers, switch disconnectors

### Terminals NZM4

Space requirement	Number of poles	For use with	Rated current <sup>1)</sup> $I_n$	Terminal capacity			Terminal capacity	
				Cable Cable lugs	Terminal capacity mm <sup>2</sup>	AWG/kcmil	Copper strip No. of discs x width x disc thickness mm	Copper bar Width x thickness mm

#### Connection width extension

1230PIC-1412 Symbolphoto

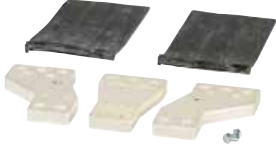

-		3 pole	NZM4 N(S)4	max. 1600	Copper cable- lugs	4 x 300 6 x 95 - 240	4 x 600 6 x 000 - 500	max. (2 x) 10 x 80 x 1.0	max. (2 x) 80 x 10

wa\_sg02416 Symbolphoto

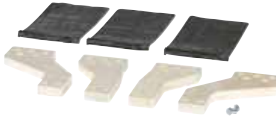

-		4 pole	NZM4-4, N4-4	max. 1600	Copper cable- lugs	4 x 300 6 x 95 - 240	4 x 600 6 x 000 - 500	max. (2 x) 10 x 80 x 1.0	max. (2 x) 80 x 10

#### With two threaded studs

1230PIC-1411 Symbolphoto



-		3 pole	NZM4, N(S)4	1600	Copper cable- lugs	4 x 95 - 300	4 x 500	(2 x) 10 x 80 x 1.0	(2 x) 10 x 80

1230PIC-1147 Symbolphoto

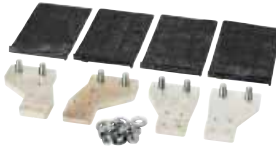

-		4 pole	NZM4-4, N4-4	1600	Copper cable- lugs	4 x 95 - 300	4 x - 500	(2x) 10 x 80 x 1.0	(2 x) 10 x 80



Part no. Article no. Std. pack Notes

Information relevant for export to North America

Article no. when ordering separately







Part no.	Article no.	Std. pack	Notes	Product Standards
NZM4-XKV95	281591	1 set	Contains parts for a terminal located at top or bottom for 3 or 4 pole switches	UL489; CSA-C22.2 No. 5-09; IEC60947, CE marking
NZM4-XKV110	281593		Five-hole fitting, for example, for up to nine cable lugs per phase. Can be fitted to circuit breaker with screw terminal. Phase isolator included as standard. Distance between pole centers: 95 mm Installation conditions for current transformer up to 130 mm width with 80 mm busbar width.	UL File No. E31593 UL CCN DIHS CSA File No. 022086 CSA Class No. 1432-01 NA Certification UL listed, CSA certified Suitable for Refer to main component information
NZM4-4-XKV95	281592	1 set	4 mm holes predrilled for control circuit terminal. Contains hole for large cover NZM4(-4)-XKSAV	-
NZM4-4-XKV120	281594			





Part no.	Article no.	Std. pack	Notes	Product Standards
NZM4-XKV95-2KB	119861	1 set	Type contains parts for 3 to 4-pole switches on top or bottom of switch. Double stud bolts M12 for e. g. up to 4 cable lugs 300 mm <sup>2</sup> per phase. For fitting to switches with screw connection. Distance between pole centers if 95 mm Can be fitted to current transformers up to 130 mm in width and with a bar width of 80 mm. 4 mm drilling dimensions for control circuit terminal available. Hole for large cover NZM4(-4)-XKSAV included	UL489; CSA-C22.2 No. 5-09; IEC60947, CE marking UL File No. E31593 UL CCN DIHS CSA File No. 022086 CSA Class No. 1432-01 NA Certification UL listed, CSA certified Suitable for Refer to main component information
NZM4-4-XKV95-2KB	132674	1 set		

# 4.4

## Compact circuit breakers, switch disconnectors

### Terminals NZM4

	Number of poles	For use with	Terminal capacity		AWG/kcmil
			Connection	Terminal capacity mm <sup>2</sup>	
<b>Cover</b>					
1230PIC-1354 Symbolphoto 	3 pole	NZM4, N(S)4	-	-	-
1230PIC-1355 Symbolphoto 	4 pole	NZM4-4 N4-4	-	-	-
<b>Cover size</b>					
For connection width extension					
1230PIC-699 Symbolphoto 	3 pole	NZM4, N(S)4 + NZM4-XKV95(KB)	-	-	-
1230PIC-696 Symbolphoto 	4 pole	NZM4-4, N(S)4-4 + NZM4-4-XKV95(KB)	-	-	-
<b>Insulation plate</b>					
1230PIC-315 Symbolphoto 	3 pole	NZM4, - N(S)4 + NZM4-XKV...	-	-	-
	4 pole	NZM4-4 N4-4 + NZM4-4-XKV...	-	-	-

Part no.	Article no.	Std. pack	Notes	Information relevant for export to North America
Article no. when ordering separately				
NZM4-XKSA	266846	1 set 	Type contains parts for a terminal located at top or bottom for 3 pole circuit breakers. Insulation/protection against direct contact where cable lugs or busbars are connected or tunnel terminals are used. Included in the set with tunnel terminals. When using insulated conductor material to IP1X.	Product Standards UL 489; CSA-C22.2 No. 5-09; IEC 60947; CE marking UL File No. E31593 UL CCN DIHS CSA File No. 022086 CSA Class No. 1432-01 NA Certification UL listed, CSA certified Suitable for UL listed, CSA certified
NZM4-4-XKSA	266847	1 set		-
NZM4-XKSAV	119876	1 set 	Type contains parts for a terminal located at top or bottom for 3 pole circuit breakers. Insulation protection/busbar tag shroud for connection of cable lugs or busbars to connection width extension. When using insulated conductor material to IP2X. Cannot be combined with connection width extension NZM4-XKV110.	UL/CSA certification not required
NZM4-4-XKSAV	132676	1 set 	Type contains parts for a terminal located at top or bottom for 4 pole circuit breakers. Insulation protection / busbar tag shroud for connection of cable lugs or busbars to connection width extension. Cannot be combined with connection width extension NZM4-4-XKV120. When using insulated conductor material to IP2X.	-
NZM4-XISP	119866	1 set 	Type contains parts for a terminal located at top or bottom for 3 or 4 pole circuit breakers. Insulation protection to mounting plate when minimum clearances are not maintained. Included with the connection width extension.	Product Standards UL 489; CSA-C22.2 No. 5-09; IEC 60947; CE marking NA Certification Request filed for UL and CSA Suitable for Refer to main component information
NZM4-4-XISP	119867	1 set		-

# 4.4

## Compact circuit breakers, switch disconnectors

### Terminals NZM4

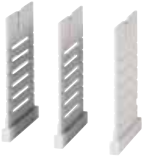
	Number of poles	For use with	Terminal capacity Connection	Terminal capacity mm <sup>2</sup>	AWG/kcmil
<b>Terminal covers, knockout</b>					
1230PIC-745 Symbolphoto 	3 pole	NZM4, N(S)4	-	-	-
wa_sg07218 Symbolphoto 	4 pole	NZM4-4, N4-4	-	-	-
<b>Phase isolators</b>					
sg09215 Symbolphoto 	3 pole	NZM4, N(S)4	-	-	-
sg08815 Symbolphoto 	4 pole	NZM4-4, N4-4	-	-	-

Part no.	Article no.	Std. pack	Notes	Information relevant for export to North America
Article no. when ordering separately				
NZM4-XKSFA	292193	1 set	Part no. includes parts for a top or bottom terminal for 3 pole circuit breakers, including in combination with NZM4-XKSA cover. Increased busbar tag shroud with connection of insulated bars or flat band.	UL/CSA certification not required
NZM4-4-XKSFA	292194	1 set	-	-
NZM4-XKP	281595	1 set	Type contains parts for a terminal located at top or bottom for 3 or 4-pole circuit breakers. Included with the connection width extension. Cannot be combined with the tunnel terminal NZM4(-4)-XKA, connection NZM4-XKR on rear. Insulation protection where cable lugs, busbars, module plates or flat cable terminals are used.	Product Standards UL 489; CSA-C22.2 No. 5-09; IEC 60947; CE marking UL File No. E31593 UL CCN DIHS CSA File No. 022086 CSA Class No. 1432-01 NA Certification UL listed, CSA certified Suitable for Refer to main component information
NZM4-4-XKP	281596	1 set	-	-

# 4.4









## Compact circuit breakers, switch disconnectors

### Terminals NZM4

For use with	Rated current $I_n$	Number of poles	Part no. Article no. when ordering separately	Article no.	Std. pack	Notes
A						

#### Adapter set N(ZM)4/N(ZM)12

Not UL/CSA approved

<p>1230PIC-778 Symbolphoto</p> 	N4	max. 1000	3 pole	N4-XAS12-1000	285609	1 set	<p>Mounting position: NZM3: vertical, 90° left NZM4: vertical</p> <p>3 positions: Connected, test, disconnected Position indication is mechanical with pointers. Additional electrical indication with auxiliary contacts possible. One N/O or NC contact M22-(C)K01 or M22-(C)K10 each per position. Alternatively also double contacts M22-CK...</p>
<p>1230PIC-779 Symbolphoto</p> 	N4	max. 1250	3 pole	N4-XAS12-1250	285610		
<p>1230PIC-780 Symbolphoto</p> 	N4	max. 1600	3 pole	N4-XAS12-1600	285611		
<p>1230PIC-778 Symbolphoto</p> 	NZM4	max. 1000	3 pole	NZM4-XAS12-1000	285612	1 set	<p>Mounting position: NZM3: vertical, 90° left NZM4: vertical</p> <p>3 positions: Connected, test, disconnected Position indication is mechanical with pointers. Additional electrical indication with auxiliary contacts possible. One N/O or NC contact M22-(C)K01 or M22-(C)K10 each per position. Alternatively also double contacts M22-CK...</p>
<p>1230PIC-779 Symbolphoto</p> 	NZM4	max. 1250	3 pole	NZM4-XAS12-1250	285613		
<p>1230PIC-780 Symbolphoto</p> 	NZM4	max. 1600	3 pole	NZM4-XAS12-1600	285614		
<p>1230PIC-781 Symbolphoto</p> 	NZM4, N4	max. 1250	3 pole	NZM4-XAS14-1250	283291	1 set	<p>Mounting position: NZM3: vertical, 90° left NZM4: vertical</p> <p>3 positions: Connected, test, disconnected Position indication is mechanical with pointers. Additional electrical indication with auxiliary contacts possible. One N/O or NC contact M22-(C)K01 or M22-(C)K10 each per position. Alternatively also double contacts M22-CK...</p>
<p>1230PIC-847 Symbolphoto</p> 	NZM4, N4	1600	3 pole	NZM4-XAS14-1600	283292		

For use with      Number of poles      Part no.      Article no.      Std. pack      Notes

### Plug-in units

For circuit breakers NZM and switch disconnectors N  
Not UL/CSA approved  
Not for  $U_e > 690$  V

### Plug-in socket

1230PIC-818 Symbolphoto



Completion through switches with plug-in insert NZM...-SVE...	NZM1 N1	3 pole	NZM1-XSVS	109777	1 Off	Mounting position: vertical, 90° right, 90° left Order control circuit plug unit separately!
---	---------	--------	-----------	--------	-------	---

1230PIC-818 Symbolphoto



	NZM2 N2	3 pole	NZM2-XSVS	266699	1 Off	
--	---------	--------	-----------	--------	-------	--

1230PIC-815 Symbolphoto



	NZM2-4 N2-4	4 pole	NZM2-4-XSVS	266700	1 Off	
--	-------------	--------	-------------	--------	-------	--

1230PIC-818 Symbolphoto



	NZM3 N3	3 pole	NZM3-XSVS	168472		Mounting position: vertical, 90° right, 90° left Order control circuit plug unit separately! Lockable base
--	---------	--------	-----------	--------	--	--

1230PIC-815 Symbolphoto



	NZM3-4 N3-4	4 pole	NZM3-4-XSVS	168473		
--	-------------	--------	-------------	--------	--	--

### Control circuit plug unit

1230PIC-770 Symbolphoto



-	NZM1, N1 NZM2(-4) N2(-4)	For auxiliary contact, shunt/ overvoltage release	NZM2-XSVHI	266705	1 Off	10 terminals
---	--------------------------------	---	------------	--------	-------	--------------

1230PIC-845 Symbolphoto



-	NZM2(-4) N2(-4)	For remote operator	NZM2-XSVR	266706	1 Off	
---	--------------------	---------------------	-----------	--------	-------	--

# 4.5

## Compact circuit breakers, switch disconnectors

Plug-in units, withdrawable units  
 NZM1, NZM2, NZM3, NZM4

For use with	Number of poles	Part no. Article no. when ordering separately	Article no.	Std. pack	Notes
--------------	-----------------	---	-------------	-----------	-------

### Withdrawable unit

For circuit breakers NZM and switch disconnectors N  
 Not UL/CSA approved  
 Not for  $U_e > 690$  V

### Socket base

For switches with withdrawable carrier.  
 Also for reserved compartments.

1230PIC-697 Symbolphoto



NZM3 N3	3 pole	NZM3-XAVS	266711	1 Off	$I_{nmax}$ at: 20°C: 605 A (NZM3), 1600 A (NZM4) 40°C: 550 A (NZM3), 1500 A (NZM4)
------------	--------	-----------	--------	-------	--

1230PIC-866 Symbolphoto



NZM3-4 N3-4	4 pole	NZM3-4-XAVS	266712	1 Off	Mounting position: NZM3: vertical, 90° left NZM4: vertical
----------------	--------	-------------	--------	-------	--

1230PIC-697 Symbolphoto



NZM4 N4	3 pole	NZM4-XAVS	266713	1 Off	3 positions: Connected, test, disconnected Position indication is mechanical with pointers. Additional electrical indication with auxiliary contacts possible. One N/O or NC contact M22-(C)K01 or M22-(C)K10 each per position. Alternatively also double contacts M22-CK... Complete with control circuit plug unit. All auxiliary contact (HIA, HIN, HIV) and shunt release connections to the control circuit plug unit are already present. Maximum configuration: 3 contacts HIN, 2 contacts HIA, 2 contacts HIV Cannot be combined with adapter set NZM4/NZM14 (NZM4-XSAS14-...) or N(ZM)4/N(ZM)12.
------------	--------	-----------	--------	-------	---

1230PIC-866 Symbolphoto



NZM4-4 N4-4	4 pole	NZM4-4-XAVS	266714	1 Off	3 positions: Connected, test, disconnected Position indication is mechanical with pointers. Additional electrical indication with auxiliary contacts possible. One N/O or NC contact M22-(C)K01 or M22-(C)K10 each per position. Alternatively also double contacts M22-CK... Complete with control circuit plug unit. All auxiliary contact (HIA, HIN, HIV) and shunt release connections to the control circuit plug unit are already present. Maximum configuration: 3 contacts HIN, 2 contacts HIA, 2 contacts HIV Cannot be combined with adapter set NZM4/NZM14 (NZM4-XSAS14-...) or N(ZM)4/N(ZM)12.
----------------	--------	-------------	--------	-------	---



## Auxiliary contacts with screw terminals/spring-cage terminal NZM1, M22-...

For use with

Contact configuration:  
⊕ = safety function by positive opening according to IEC/EN 60947-5-1

Contact sequences

Part no. Article no. when ordering separately

Article no. Std. pack

N/O = normally open contact NC = normally closed contact

### Auxiliary contacts

#### Early-make auxiliary contact

For interlocking and load shedding circuits, as well as for early make of the undervoltage release in main switch/emergency switching off applications

1230PIC-763 Symbolphoto



With clamp terminal on left switch side

NZM1(-4), 2(-4), 3(-4), 4(-4) 2 N/O  
PN1(-4), 2(-4), 3(-4)  
N(S)1(-4), 2(-4), 3(-4), 4(-4)



NZM1-XHIV 259426 1 Off

1230PIC-765 Symbolphoto



With clamp terminal on right switch side.

2 N/O



NZM1-XHIVR 292195

1230PIC-764 Symbolphoto



With 3 m connection cable instead of screw connection.

2 N/O



NZM1-XHIVL 259432

#### Notes

Information relevant for export to North America



Not in conjunction with undervoltage release NZM...-XU... or shunt release NZM...-XA...

Early make with switch on and switch off (manual actuation): approx. 20 ms

Product Standards UL489; CSA-C22.2 No. 5-09; IEC60947, CE marking  
UL File No. E140305  
UL CCN DIHS  
CSA File No. 022086  
CSA Class No. 1437-01  
NA Certification UL Listed, CSA certified

1230PIC-767 Symbolphoto



- NZM2(-4), 3(-4) 2 N/O -  
PN2(-4), 3(-4)  
N(S)2(-4), 3(-4)



NZM2/3-XHIV 259430<sup>1)</sup>  
NZM2/3-XHIV-PI 189748<sup>1)</sup>

1230PIC-782 Symbolphoto



- NZM4(-4) 2 N/O -  
N(S)4(-4)



NZM4-XHIV 266172<sup>2)</sup>  
NZM4-XHIV-PI 189749<sup>2)</sup>

#### Notes

Information relevant for export to North America



<sup>1)</sup> Not in conjunction with undervoltage release NZM...-XU..., shunt releases NZM...-XA...  
Early make with switch on and switch off (manual actuation): approx. 20 ms

<sup>2)</sup> Not in conjunction with undervoltage release NZM...-XU..., shunt releases NZM...-XA... or remote operator NZM...-XR...  
Early make (manual operation): approx. ca. 90 ms

Product Standards UL489; CSA-C22.2 No. 5-09; IEC60947, CE marking  
UL File No. E140305  
UL CCN DIHS  
CSA File No. 022086  
CSA Class No. 1437-01  
NA Certification UL Listed, CSA certified

# 4.7

## Compact circuit breakers, switch disconnectors

### Undervoltage releases NZM1

For use with	Rated control voltage	Part no.	Article no.	Std. pack	Notes
	$U_s$	Article no. when ordering separately			
	V				



#### Undervoltage releases

##### Without auxiliary contacts

Non-delayed disconnection of circuit breaker NZM or switch disconnector N when control voltage drops below 35 – 70 %  $U_s$ .  
For use with emergency switching off devices in conjunction with emergency switching off button.



1230PIC-1127 Symbolphoto



With clamp terminal on left switch side.	NZM1(-4), N(S)1(-4)	24 V 50/60 Hz 48 V 50/60 Hz 60 V 50/60 Hz 110 V - 130 V 50/60 Hz 208 V - 240 V 50/60 Hz 380 V - 440 V 50/60 Hz 480 V - 525 V 50/60 Hz 600 V 50/60 Hz 12 V DC 18 V DC 24 V DC 48 V DC 60 V DC 110 V - 130 V DC 220 V - 250 V DC	NZM1-XU24AC NZM1-XU48AC NZM1-XU60AC NZM1-XU110-130AC NZM1-XU208-240AC NZM1-XU380-440AC NZM1-XU480-525AC NZM1-XU600AC NZM1-XU12DC NZM1-XU18DC NZM1-XU24DC NZM1-XU48DC NZM1-XU60DC NZM1-XU110-130DC NZM1-XU220-250DC	259434 259436 259438 259440 259442 259444 259446 259448 259450 171798 259452 262631 259454 259458 259460	1 Off  	When the undervoltage release is de-energized, accidental contact with the main contacts of the switch during attempts to switch on is reliably prevented. Undervoltage releases cannot be installed simultaneously with early-make auxiliary contact NZM...-XHIV... or shunt release NZM...-XA...

1230PIC-1131 Symbolphoto



With 3 m connection cable instead of screw terminal.	NZM1(-4), N(S)1(-4)	24 V 50/60 Hz 110 V - 130 V 50/60 Hz 208 V - 240 V 50/60 Hz 380 V - 440 V 50/60 Hz 480 V - 525 V 50/60 Hz 600 V 50/60 Hz 12 V DC 18 V DC 24 V DC 110 V - 130 V DC 220 V - 250 V DC	NZM1-XUL24AC NZM1-XUL110-130AC NZM1-XUL208-240AC NZM1-XUL380-440AC NZM1-XUL480-525AC NZM1-XUL600AC NZM1-XUL12DC NZM1-XUL18DC NZM1-XUL24DC NZM1-XUL110-130DC NZM1-XUL220-250DC	259462 259468 259471 259473 259475 259477 259479 171799 259481 259487 259489	1 Off  

Information relevant for export to North America



Product Standards	UL489; CSA-C22.2 No. 5-09; IEC60947, CE marking
UL File No.	E140305
UL CCN	DIHS
CSA File No.	022086
CSA Class No.	1437-01
NA Certification	UL Listed, CSA certified

## Undervoltage releases NZM2/3..., NZM4

For use with	Rated control voltage	Part no.	Article no.	Std. pack	Notes
	$U_s$	Article no. when ordering separately			
	V				

### Undervoltage releases

#### Without auxiliary contacts

Non-delayed disconnection of circuit breaker NZM or switch disconnector N when control voltage drops below 35 – 70 %  $U_s$ .  
For use with emergency switching off devices in conjunction with emergency switching off button

1230PIC-1133 Symbolphoto



NZM2(-4), N(S)2(-4)	24 V 50/60 Hz	NZM2/3-XU24AC	259491	1 Off	When the undervoltage release is de-energized, accidental contact with the main switches of the switch during attempts to switch on is reliably prevented. Undervoltage release cannot be installed simultaneously with early-make auxiliary contact NZM...-XHIV... or undervoltage release NZM...-XA...
NZM3(-4), N(S)3(-4)	48 V 50/60 Hz	NZM2/3-XU48AC	259493		
	60 V 50/60 Hz	NZM2/3-XU60AC	259495		
	110 V - 130 V 50/60 Hz	NZM2/3-XU110-130AC	259497		
	208 V - 240 V 50/60 Hz	NZM2/3-XU208-240AC	259499		
	380 V - 440 V 50/60 Hz	NZM2/3-XU380-440AC	259501		
	480 V - 525 V 50/60 Hz	NZM2/3-XU480-525AC	259503		
	600 V 50/60 Hz	NZM2/3-XU600AC	259505		
	12 V DC	NZM2/3-XU12DC	259507		
	18 V DC	NZM2/3-XU18DC	171802		
	24 V DC	NZM2/3-XU24DC	259509		
	48 V DC	NZM2/3-XU48DC	259511		
	60 V DC	NZM2/3-XU60DC	259513		
	110 V - 130 V DC	NZM2/3-XU110-130DC	259515		
	220 V - 250 V DC	NZM2/3-XU220-250DC	259517		

1230PIC-1148 Symbolphoto



NZM4(-4), N(S)4(-4)	24 V 50/60 Hz	NZM4-XU24AC	266189	1 Off	
	48 V 50/60 Hz	NZM4-XU48AC	266190		
	60 V 50/60 Hz	NZM4-XU60AC	266191		
	110 V - 130 V 50/60 Hz	NZM4-XU110-130AC	266192		
	208 V - 240 V 50/60 Hz	NZM4-XU208-240AC	266193		
	380 V - 440 V 50/60 Hz	NZM4-XU380-440AC	266194		
	480 V - 525 V 50/60 Hz	NZM4-XU480-525AC	266195		
	600 V 50/60 Hz	NZM4-XU600AC	266196		
	12 V DC	NZM4-XU12DC	266203		
	18 V DC	NZM4-XU18DC	171804		
	24 V DC	NZM4-XU24DC	266204		
	48 V DC	NZM4-XU48DC	266205		
	60 V DC	NZM4-XU60DC	266206		
	110 V - 130 V DC	NZM4-XU110-130DC	266207		
	220 V - 250 V DC	NZM4-XU220-250DC	266208		

Information relevant for export to North America



Product Standards	UL489; CSA-C22.2 No. 5-09; IEC60947, CE marking
UL File No.	E140305
UL CCN	DIHS
CSA File No.	022086
CSA Class No.	1437-01
NA Certification	UL Listed, CSA certified

# 4.7

## Compact circuit breakers, switch disconnectors

### Undervoltage releases NZM1, NZM2/3

For use with	Rated control voltage	Part no.	Article no.	Std. pack	Notes
	$U_c$	Article no. when ordering separately			
	V				

#### Undervoltage releases

##### With two early-make auxiliary contacts



For interlocking and load-shedding circuits, as well as for early-make of the undervoltage release in main-switch applications.

For use with emergency switching off devices in conjunction with emergency switching off button.

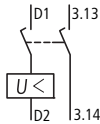
1230PIC-1128 Symbolphoto



With clamp terminal on left switch side.



NZM1(-4), 24 V 50/60 Hz	NZM1-XUHIV24AC	259531	1 Off	
N(S)1(-4) 48 V 50/60 Hz	NZM1-XUHIV48AC	259533		 
60 V 50/60 Hz	NZM1-XUHIV60AC	259535		
110 V - 130 V 50/60 Hz	NZM1-XUHIV110-130AC	259537		
208 V - 240 V 50/60 Hz	NZM1-XUHIV208-240AC	259539		
380 V - 440 V 50/60 Hz	NZM1-XUHIV380-440AC	259541		
480 V - 525 V 50/60 Hz	NZM1-XUHIV480-525AC	259543		
12 V DC	NZM1-XUHIV12DC	259545		
18 V DC	NZM1-XUHIV18DC	171800		
24 V DC	NZM1-XUHIV24DC	259547		
48 V DC	NZM1-XUHIV48DC	259549		
60 V DC	NZM1-XUHIV60DC	259551		
110 V - 130 V DC	NZM1-XUHIV110-130DC	259553		
220 V - 250 V DC	NZM1-XUHIV220-250DC	259555		

When the undervoltage release is de-energized, accidental contact with the main contacts of the switch during attempts to switch on is reliably prevented. Early-make of auxiliary contacts on switching on and off (manual operation): approx. 20 ms. Undervoltage releases cannot be installed simultaneously with early-make auxiliary contact NZM...-XHIV... or shunt release NZM...-XA...

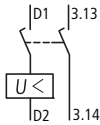
1230PIC-1306 Symbolphoto





With 3 m connection cable instead of screw connection.

NZM1(-4), 24 V 50/60 Hz	NZM1-XUHIVL24AC	259557	1 Off	
N(S)1(-4) 110 V - 130 V 50/60 Hz	NZM1-XUHIVL110-130AC	259563		 
208 V - 240 V 50/60 Hz	NZM1-XUHIVL208-240AC	259565		
380 V - 440 V 50/60 Hz	NZM1-XUHIVL380-440AC	259567		
480 V - 525 V 50/60 Hz	NZM1-XUHIVL480-525AC	259569		
12 V DC	NZM1-XUHIVL12DC	259571		
18 V DC	NZM1-XUHIVL18DC	171801		
24 V DC	NZM1-XUHIVL24DC	259573		
110 V - 130 V DC	NZM1-XUHIVL110-130DC	259579		
220 V - 250 V DC	NZM1-XUHIVL220-250DC	259581		

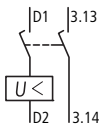
1230PIC-1134 Symbolphoto



NZM2(-4), 24 V 50/60 Hz	NZM2/3-XUHIV24AC	259583	1 Off	
N(S)2(-4) 48 V 50/60 Hz	NZM2/3-XUHIV48AC	259585		 
NZM3(-4), 60 V 50/60 Hz	NZM2/3-XUHIV60AC	259587		
N(S)3(-4) 110 V - 130 V 50/60 Hz	NZM2/3-XUHIV110-130AC	259589		
208 V - 240 V 50/60 Hz	NZM2/3-XUHIV208-240AC	259591		
380 V - 440 V 50/60 Hz	NZM2/3-XUHIV380-440AC	259594		
480 V - 525 V 50/60 Hz	NZM2/3-XUHIV480-525AC	259598		
12 V DC	NZM2/3-XUHIV12DC	259600		
18 V DC	NZM2/3-XUHIV18DC	171803		
24 V DC	NZM2/3-XUHIV24DC	259602		
48 V DC	NZM2/3-XUHIV48DC	259604		
60 V DC	NZM2/3-XUHIV60DC	259606		
110 V - 130 V DC	NZM2/3-XUHIV110-130DC	259608		
220 V - 250 V DC	NZM2/3-XUHIV220-250DC	259610		

When the undervoltage release is de-energized, accidental contact with the main contacts of the switch during attempts to switch on is reliably prevented. Early-make of auxiliary contacts on switching on and off (manual operation): approx. 20 ms. Cannot be used in conjunction with remote operator NZM...-XR.... Undervoltage releases cannot be installed simultaneously with early-make auxiliary contact NZM...-XHIV... or shunt release NZM...-XA....

Information relevant for export to North America



Product Standards	UL489; CSA-C22.2 No. 5-09; IEC60947, CE marking
UL File No.	E140305
UL CCN	DIHS
CSA File No.	022086
CSA Class No.	1437-01
NA Certification	UL Listed, CSA certified

## Undervoltage releases NZM2/3..., NZM4

For use with	Rated control voltage	Part no.	Article no.	Std. pack	Notes
	$U_c$	Article no. when ordering separately			
	V				

### Undervoltage releases

#### With two early-make auxiliary contacts

For interlocking and load-shedding circuits, as well as for early-make of the undervoltage release in main-switch applications. For use with emergency switching off devices in conjunction with emergency switching off button.

1230PIC-1149 Symbolphoto

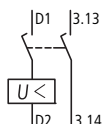

NZM4(-4),	24 V 50/60 Hz	NZM4-XUHIV24AC	266217	1 Off	When the undervoltage release is de-energized, accidental contact with the main contacts of the switch during attempts to switch on is reliably prevented. Early make of auxiliary contacts on switching on (manual operation): approx. 90 ms Cannot be used in conjunction with remote operator NZM...-XR... Undervoltage release cannot be installed together with early-make auxiliary contact NZM...-XHIV... or shunt release NZM...-XA...
N(S)4(-4)	48 V 50/60 Hz	NZM4-XUHIV48AC	266218		
	60 V 50/60 Hz	NZM4-XUHIV60AC	266219		
	110 V - 130 V 50/60 Hz	NZM4-XUHIV110-130AC	266220		
	208 V - 240 V 50/60 Hz	NZM4-XUHIV208-240AC	266221		
	380 V - 440 V 50/60 Hz	NZM4-XUHIV380-440AC	266222		
	480 V - 525 V 50/60 Hz	NZM4-XUHIV480-525AC	266223		
	12 V DC	NZM4-XUHIV12DC	266231		
	18 V DC	NZM4-XUHIV18DC	171805		
	24 V DC	NZM4-XUHIV24DC	266232		
	48 V DC	NZM4-XUHIV48DC	266233		
	60 V DC	NZM4-XUHIV60DC	266234		
	110 V - 130 V DC	NZM4-XUHIV110-130DC	266235		
	220 V - 250 V DC	NZM4-XUHIV220-250DC	266236		

1230PIC-1130 Symbolphoto

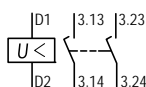

#### With 2 separate early-make auxiliary contacts

With 3 m connection cable instead of screw terminal.

NZM1(-4),	24 V 50/60 Hz	NZM1-XUHIV20L24AC	259612	1 Off	When the undervoltage release is de-energized, accidental contact with the main contacts of the switch during attempts to switch on is reliably prevented. Early make of auxiliary contacts on switching on (manual operation): approx. 20 ms Cannot be used in conjunction with remote operator NZM...-XR... Undervoltage release cannot be installed together with early-make auxiliary contact NZM...-XHIV... or shunt release NZM...-XA...
N(S)1(-4)	110 V - 130 V 50/60 Hz	NZM1-XUHIV20L110-130AC	259620		
	208 V - 240 V 50/60 Hz	NZM1-XUHIV20L208-240AC	259622		
	380 V - 440 V 50/60 Hz	NZM1-XUHIV20L380-440AC	259624		
	420 - 480 V 50/60 Hz	NZM1-XUHIV20L420-480VAC	105946		
	24 V DC	NZM1-XUHIV20L24DC	259630		
	18 V DC	NZM1-XUHIV20L18DC	171807		

Contacts 3.23 and 3.24 with separate 3 m connection cables.

1230PIC-768 Symbolphoto

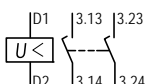

NZM2(-4),	24 V 50/60 Hz	NZM2/3-XUHIV2024AC	259640	1 Off	When the undervoltage release is de-energized, accidental contact with the main contacts of the switch during attempts to switch on is reliably prevented. Early make of auxiliary contacts on switching on (manual operation): approx. 20 ms Cannot be used in conjunction with remote operator NZM...-XR... Undervoltage release cannot be installed together with early-make auxiliary contact NZM...-XHIV... or shunt release NZM...-XA...
N(S)2(-4)	48 V 50/60 Hz	NZM2/3-XUHIV2048AC	259643		
NZM3(-4),	110 V - 130 V 50/60 Hz	NZM2/3-XUHIV20110-130AC	259648		
N(S)3(-4)	208 V - 240 V 50/60 Hz	NZM2/3-XUHIV20208-240AC	259651		
	380 V - 440 V 50/60 Hz	NZM2/3-XUHIV20380-440AC	259653		
	420 - 480 V 50/60 Hz	NZM2/3-XUHIV20420-480VAC	105947		
	24 V DC	NZM2/3-XUHIV2024DC	259659		
	18 V DC	NZM2/3-XUHIV2018DC	171808		

Information relevant for export to North America



Product Standards	UL489; CSA-C22.2 No. 5-09; IEC60947, CE marking
UL File No.	E140305
UL CCN	DIHS
CSA File No.	022086
CSA Class No.	1437-01
NA Certification	UL Listed, CSA certified

# 4.7

## Compact circuit breakers, switch disconnectors

### Undervoltage releases NZM1, NZM2/3..., NZM4

For use with	Rated control voltage	Part no.	Article no.	Std. pack	Notes
	$U_s$	Article no. when ordering separately			
	V				

#### Undervoltage releases

##### With 2 separate early-make auxiliary contacts

For use with emergency switching off devices in conjunction with emergency switching off button.

Coil connections wired to clamp terminals, auxiliary contact connections with 3 m loose connection cables.

1230PIC-1181 Symbolphoto

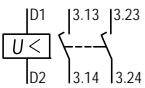

NZM1(-4),	24 V 50/60 Hz	NZM1-XUHIV20KL24AC	284388	1 Off	When the undervoltage release is de-energized, accidental contact with the main contacts of the switch during attempts to switch on is reliably prevented. Early make of auxiliary contacts on switching on and off (manual operation): approx. 20 ms Cannot be used in conjunction with remote operator NZM...-XR... Undervoltage release cannot be installed simultaneously with early-make auxiliary contact NZM...-XHIV... or shunt release NZM...-XA...
N(S)1(-4)	110 V - 130 V 50/60 Hz	NZM1-XUHIV20KL110-130AC	284389		
	208 V - 240 V 50/60 Hz	NZM1-XUHIV20KL208-240AC	284400		
	24 V DC	NZM1-XUHIV20KL24DC	284387		

1230PIC-1129 Symbolphoto

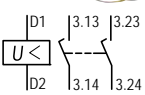

Coil connections with 3 m loose connection cables, auxiliary contact connections wired to clamp terminals

NZM1(-4),	24 V 50/60 Hz	NZM1-XUHIV20LK24AC	284402	1 Off	When the undervoltage release is de-energized, accidental contact with the main contacts of the switch during attempts to switch on is reliably prevented. Early make of auxiliary contacts on switching on and off (manual operation): approx. 20 ms Cannot be used in conjunction with remote operator NZM...-XR... Undervoltage release cannot be installed simultaneously with early-make auxiliary contact NZM...-XHIV... or shunt release NZM...-XA...
N(S)1(-4)	110 V - 130 V 50/60 Hz	NZM1-XUHIV20LK110-130AC	284403		
	208 V - 240 V 50/60 Hz	NZM1-XUHIV20LK208-240AC	284404		
	24 V DC	NZM1-XUHIV20LK24DC	284401		

1230PIC-1319 Symbolphoto

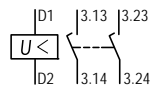

Contacts 3.23 and 3.24 with separate 3 m connection cables

NZM4(-4),	24 V 50/60 Hz	NZM4-XUHIV2024AC	266244	1 Off	When the undervoltage release is de-energized, accidental contact with the main contacts of the switch during attempts to switch on is reliably prevented. Early make of auxiliary contacts on switching on and off (manual operation): approx. 20 ms Cannot be used in conjunction with remote operator NZM...-XR... Undervoltage release cannot be installed simultaneously with early-make auxiliary contact NZM...-XHIV... or shunt release NZM...-XA...
N(S)4(-4)	110 V - 130 V 50/60 Hz	NZM4-XUHIV20110-130AC	266247		
	208 V - 240 V 50/60 Hz	NZM4-XUHIV20208-240AC	266248		
	380 V - 440 V 50/60 Hz	NZM4-XUHIV20380-440AC	266249		
	18 V DC	NZM4-XUHIV2018DC	171809		
	24 V DC	NZM4-XUHIV2024DC	266258		

Information relevant for export to North America



Product Standards	UL489; CSA-C22.2 No. 5-09; IEC60947, CE marking
UL File No.	E140305
UL CCN	DIHS
CSA File No.	022086
CSA Class No.	1437-01
NA Certification	UL Listed, CSA certified

For use with	Rated control voltage	Part no.	Article no.	Std. pack	Notes
	$U_s$	Article no. when ordering separately			
	V				

### Undervoltage releases

#### Without auxiliary contact - with push in terminal

Instantaneous shut-off of the NZM circuit breaker when the control voltage drops below 35 - 70 %  $U_s$ .  
For use with emergency-stop devices in connection with an emergency-stop button.

wa\_sg07618 Symbolphoto



NZM2(-4),	24 V AC 50/60 Hz	NZM2/3-XU24AC-PI	189750	1 Off	If the shunt trip is live, contact with the circuit breaker's primary contacts is prevented when switched on. Undervoltage release modules cannot be installed simultaneously with early-make contact NZM...-XHIV, shunt release NZM...-XA... or relais modules NZM...-X2A...
N(S)2(-4)	48 V AC 50/60 Hz	NZM2/3-XU48AC-PI	189751		
NZM3(-4),	60 V AC 50/60 Hz	NZM2/3-XU60AC-PI	189752		
N(S)3(-4)	110 - 130 V AC 50/60 Hz	NZM2/3-XU110-130AC-PI	189753		
	208 - 240 V AC 50/60 Hz	NZM2/3-XU208-240AC-PI	189754		
	12 V DC	NZM2/3-XU12DC-PI	189755		
	18 V DC	NZM2/3-XU18DC-PI	189756		
	24 V DC	NZM2/3-XU24DC-PI	189757		
	48 V DC	NZM2/3-XU48DC-PI	189758		
	60 V DC	NZM2/3-XU60DC-PI	189759		
	110 - 130 V DC	NZM2/3-XU110-130DC-PI	189760		
	220 - 250 V DC	NZM2/3-XU220-250DC-PI	189761		

wa\_sg08018 Symbolphoto



NZM4(-4),	24 V AC 50/60 Hz	NZM4-XU24AC-PI	189762	1 Off	
N(S)4(-4)	48 V AC 50/60 Hz	NZM4-XU48AC-PI	189763		
	60 V AC 50/60 Hz	NZM4-XU60AC-PI	189764		
	110 - 130 V AC 50/60 Hz	NZM4-XU110-130AC-PI	189765		
	208 - 240 V AC 50/60 Hz	NZM4-XU208-240AC-PI	189766		
	12 V DC	NZM4-XU12DC-PI	189767		
	18 V DC	NZM4-XU18DC-PI	189768		
	24 V DC	NZM4-XU24DC-PI	189769		
	48 V DC	NZM4-XU48DC-PI	189770		
	60 V DC	NZM4-XU60DC-PI	189771		
	110 - 130 V DC	NZM4-XU110-130DC-PI	189772		
	220 - 250 V DC	NZM4-XU220-250DC-PI	189773		

Information relevant for export to North America



Product Standards UL489; CSA-C22.2 No. 5-09; IEC60947, CE marking

UL File No. E140305

UL CCN DIHS

CSA File No. 022086

CSA Class No. 1437-01

NA Certification UL Listed, CSA certified

# 4.7

## Compact circuit breakers, switch disconnectors

### Undervoltage releases NZM2/3, NZM4

For use with	Rated control voltage	Part no.	Article no.	Std. pack	Notes
	$U_s$	Article no. when ordering separately			
	V				

#### Undervoltage releases

##### With two early-make auxiliary contacts - with Push-In terminals

For interlocking and load-shedding circuits, as well as for early-make of the undervoltage release in main-switch applications. For use with emergency switching off devices in conjunction with emergency switching off button.

wa\_sg07518 Symbolphoto



NZM2(-4),	24 V AC 50/60 Hz	NZM2/3-XUHIV24AC-PI	189774	1 Off	When the undervoltage release is de-energized, accidental contact with the main contacts of the switch during attempts to switch on is reliably prevented. Early-make of auxiliary contacts on switching on and off (manual operation): approx. 20 ms Undervoltage releases cannot be installed simultaneously with early-make auxiliary contact NZM...-XHIV... or shunt release NZM...-XA...
N(S)2(-4)	48 V AC 50/60 Hz	NZM2/3-XUHIV48AC-PI	189775		
NZM3(-4),	60 V AC 50/60 Hz	NZM2/3-XUHIV60AC-PI	189776		
N(S)3(-4)	110 - 130 V AC 50/60 Hz	NZM2/3-XUHIV110-130AC-PI	189777		
	208 - 240 V AC 50/60 Hz	NZM2/3-XUHIV208-240AC-PI	189778		
	12 V DC	NZM2/3-XUHIV12DC-PI	189779		
	18 V DC	NZM2/3-XUHIV18DC-PI	189780		
	24 V DC	NZM2/3-XUHIV24DC-PI	189781		
	48 V DC	NZM2/3-XUHIV48DC-PI	189782		
	60 V DC	NZM2/3-XUHIV60DC-PI	189783		
	110 - 130 V DC	NZM2/3-XUHIV110-130DC-PI	189784		
	220 - 250 V DC	NZM2/3-XUHIV220-250DC-PI	189785		

wa\_sg07818 Symbolphoto



NZM1(-4),	24 V AC 50/60 Hz	NZM4-XUHIV24AC-PI	189786	1 Off	
N(S)1(-4)	48 V AC 50/60 Hz	NZM4-XUHIV48AC-PI	189787		
	60 V AC 50/60 Hz	NZM4-XUHIV60AC-PI	189788		
	110 - 130 V AC 50/60 Hz	NZM4-XUHIV110-130AC-PI	189789		
	208 - 240 V AC 50/60 Hz	NZM4-XUHIV208-240AC-PI	189790		
	12 V DC	NZM4-XUHIV12DC-PI	189791		
	18 V DC	NZM4-XUHIV18DC-PI	189792		
	24 V DC	NZM4-XUHIV24DC-PI	189793		
	48 V DC	NZM4-XUHIV48DC-PI	189794		
	60 V DC	NZM4-XUHIV60DC-PI	189795		
	110 - 130 V DC	NZM4-XUHIV110-130DC-PI	189796		
	220 - 250 V DC	NZM4-XUHIV220-250DC-PI	189797		

Information relevant for export to North America



Product Standards	UL489; CSA-C22.2 No. 5-09; IEC60947, CE marking
UL File No.	E140305
UL CCN	DIHS
CSA File No.	022086
CSA Class No.	1437-01
NA Certification	UL Listed, CSA certified



## Undervoltage releases, switch-off delayed NZM2/3..., NZM4

For use with	Part no.	Article no.	Std. pack	Notes
	Article no. when ordering separately			

### Undervoltage releases, off-delayed

Combination of separate delay unit and special releases.

For use with emergency switching off devices in conjunction with emergency switching off button. Not UL/CSA approved.

#### Delay unit

Voltage dips of less than 0.06 – 16 s do not cause disconnection of the NZM circuit breaker or N switch disconnector.

NZM1(-4), 2(-4), 3(-4), 4(-4) UVU-NZM  
N(S)1(-4), 2(-4), 3(-4), 4(-4)

260154 1 Off

Delay time can be set from 70 ms - 4 s.  
With additional external capacitor:

- 30.000 µF ≥ 35 V up to 8 s
- 90.000 µF ≥ 35 V up to 16 s

Cannot be installed simultaneously with early-make auxiliary contact NZM...-XHIV... or shunt release NZM...-XA....

Delay unit for separate installation (mounting: top-hat rail or screws).

For other operating voltages use a control transformer.

50/60 Hz  
220 V - 240 V  
380 V - 440 V  
480 V - 550 V

DC/AC  
24 V

1230PIC-795 Symbolphoto



#### Special trip block

For combination with separate delay unit

#### Without auxiliary contacts

NZM1 with 3 m loose connection cables instead of screw terminal, NZM2, 3, and 4 with screw terminals.

NZM1(-4) NZM1-XUVL  
N(S)1(-4)

271607 1 Off

Delay unit UVU-NZM is additionally required.

NZM2(-4), N(S)2(-4) NZM2/3-XUV  
NZM3(-4), N(S)3(-4)

259527

Cannot be installed simultaneously with separate early-make auxiliary contact NZM...-XHIV... or shunt release NZM...-XA....

NZM4(-4) NZM4-XUV  
N(S)4(-4)

266588

#### With two early-make auxiliary contacts

NZM1(-4) NZM1-XUVHIVL  
N(S)1(-4)

271608 1 Off

Cannot be used in conjunction with remote operator NZM...-XR....

NZM2(-4), N(S)2(-4) NZM2/3-XUVHIV  
NZM3(-4), N(S)3(-4)

259684

Delay unit UVU-NZM is additionally required.

NZM4(-4) NZM4-XUVHIV  
N(S)4(-4)

266596

Cannot be installed simultaneously with separate early-make auxiliary contact NZM...-XHIV... or shunt release NZM...-XA....

#### With two independently operating early-make auxiliary contacts

NZM1 with 3 m separate connection cables instead of screw terminal, NZM2, 3 and 4 with screw terminal, contact 3.23 and 3.24 with 3 m separate connection cables

NZM1(-4) NZM1-XUVHIV20L  
N(S)1(-4)

271609 1 Off

NZM1, 2, 3: Early make of auxiliary contacts on switching on and off

NZM2(-4), N(S)2(-4) NZM2/3-XUVHIV20  
NZM3(-4), N(S)3(-4)

259688

(manual operation): approx. 20 ms.

NZM4(-4) NZM4-XUVHIV20  
N(S)4(-4)

266604

NZM4: Early make of auxiliary contacts on switching on (manual operation): approx. 90 ms.

1230PIC-1148 Symbolphoto



1230PIC-1149 Symbolphoto

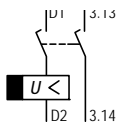

1230PIC-1319 Symbolphoto

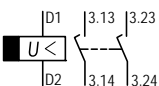

# 4.8

## Compact circuit breakers, switch disconnectors

### Shunt releases

#### NZM1, NZM2/3, NZM4

For use with	Rated control voltage	Part no.	Article no.	Std. pack	Notes
	$U_s$	Article no. when ordering separately			
	V				

#### Shunt releases

##### Without auxiliary contacts

Switches are tripped by a voltage pulse or by the application of uninterrupted voltage.

1230PIC-756 Symbolphoto



With clamp terminal on left switch side	NZM1(-4), N(S)1(-4)	Rated control voltage	Part no.	Article no.	Std. pack	Notes
		12 V AC/DC	NZM1-XA12AC/DC	259706	1 Off	When the shunt release is live, contact with the switch's main contacts on switching on is reliably prevented. Undervoltage releases cannot be installed simultaneously with early-make auxiliary contact NZM...-XHIV... or shunt release NZM...-XU... .
		24 V AC/DC	NZM1-XA24AC/DC	259708		
		48 V AC/DC	NZM1-XA48AC/DC	259720		
		60 V AC/DC	NZM1-XA60AC/DC	259722		
		110 V - 130 V AC/DC	NZM1-XA110-130AC/DC	259724		
		208 V - 250 V AC/DC	NZM1-XA208-250AC/DC	259726		
		380 V - 440 V AC/DC	NZM1-XA380-440AC/DC	259728		
		480 V - 525 V AC/DC	NZM1-XA480-525AC/DC	259730		

1230PIC-838 Symbolphoto



With 3 m connection cable instead of screw terminal	NZM1(-4), N(S)1(-4)	Rated control voltage	Part no.	Article no.	Std. pack	Notes
		12 V AC/DC	NZM1-XAL12AC/DC	259734	1 Off	
		24 V AC/DC	NZM1-XAL24AC/DC	259736		
		110 V - 130 V AC/DC	NZM1-XAL110-130AC/DC	259742		
		208 V - 250 V AC/DC	NZM1-XAL208-250AC/DC	259744		
		380 V - 440 V AC/DC	NZM1-XAL380-440AC/DC	259746		
		480 V - 525 V AC/DC	NZM1-XAL480-525AC/DC	259748		

1230PIC-1370 Symbolphoto



	NZM2(-4), N(S)2(-4)	Rated control voltage	Part no.	Article no.	Std. pack	Notes
		12 V AC/DC	NZM2/3-XA12AC/DC	259752	1 Off	
		24 V AC/DC	NZM2/3-XA24AC/DC	259754		
	NZM3(-4), N(S)3(-4)	48 V AC/DC	NZM2/3-XA48AC/DC	259756		
		60 V AC/DC	NZM2/3-XA60AC/DC	259758		
		110 V - 130 V AC/DC	NZM2/3-XA110-130AC/DC	259760		
		208 V - 250 V AC/DC	NZM2/3-XA208-250AC/DC	259763		
		380 V - 440 V AC/DC	NZM2/3-XA380-440AC/DC	259766		
		480 V - 525 V AC/DC	NZM2/3-XA480-525AC/DC	259768		

1230PIC-1387 Symbolphoto



	NZM4(-4), N(S)4(-4)	Rated control voltage	Part no.	Article no.	Std. pack	Notes
		12 V AC/DC	NZM4-XA12AC/DC	266446	1 Off	
		24 V AC/DC	NZM4-XA24AC/DC	266447		
		48 V AC/DC	NZM4-XA48AC/DC	266448		
		60 V AC/DC	NZM4-XA60AC/DC	266449		
		110 V - 130 V AC/DC	NZM4-XA110-130AC/DC	266450		
		208 V - 250 V AC/DC	NZM4-XA208-250AC/DC	266451		
		380 V - 440 V AC/DC	NZM4-XA380-440AC/DC	266452		
		480 V - 525 V AC/DC	NZM4-XA480-525AC/DC	266453		

Information relevant for export to North America



Product Standards	UL489; CSA-C22.2 No. 5-09; IEC60947, CE marking
UL File No.	E140305
UL CCN	DIHS
CSA File No.	022086
CSA Class No.	1437-01
NA Certification	UL Listed, CSA certified

For use with	Part no.	Article no.	Std. pack	Notes
	Mit Screw terminals			

### Shunt releases

Capacitor unit 230 V 50/60 Hz in conjunction with shunt release NZM...-XA208-250 AC/DC  
Enclosure: degree of protection IP20  
Not UL/CSA approved

1230PIC-788 Symbolphoto



NZM1(-4), N(S)1(-4) NZM2(-4), N(S)2(-4) NZM3(-4), N(S)3(-4) NZM4(-4), N(S)4(-4)	NZM-XCM	229413	1 Off	<p>Enables the reliable use of circuit breakers as mesh network circuit breakers in the range from 0 – 110 % <math>U_n</math> with constant switch-off time of 40 ms.</p> <p>If the mains voltage is absent, the installed capacitor supplies power for actuating the shunt release for at least 12 hours.</p> <p>The capacitor unit is arranged independently of the circuit breaker.</p> <p>Connect NZM-XCM to the power feed side.</p> <p>Note on engineering: Connect a standard auxiliary contact (HIN) as N/O in series with the coil of the shunt release!</p> <p>Standard auxiliary contact not included as standard</p>
--	---------	--------	-------	--

### Shunt releases

For mesh network circuit breakers  
For intermittent operation  
Maximum On-time = 1 s  
Operating range 10-110 %  $U_s$   
Not UL/CSA approved

1230PIC-1382 Symbolphoto

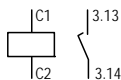

Without auxiliary contacts	NZM3-XA-230AC-MNS	274097	1 Off	<p>Rated control voltage 230 V AC For use with NZM3(-4), N3(-4) and NZM4(-4), N4(-4) Cannot be installed simultaneously with early-make auxiliary contact NZM...-XHIV... or undervoltage release NZM...-XU....</p> <p>Intermittent operation guaranteed by series connection of a make contact M22-(C)K10. The maximum duty factor of the shunt releases for mesh network circuit breakers is 1 s.</p>
With early-make auxiliary contact	NZM3-XAHIV-230AC-MNS	274141		
Without auxiliary contacts	NZM4-XA-230AC-MNS	274138		<p>Intermittent operation guaranteed by series connection of a make contact M22-(C)K10. The maximum duty factor of the shunt releases for mesh network circuit breakers is 1 s.</p>
With early-make auxiliary contact	NZM4-XAHIV-230AC-MNS	274143		

sg07615 Symbolphoto

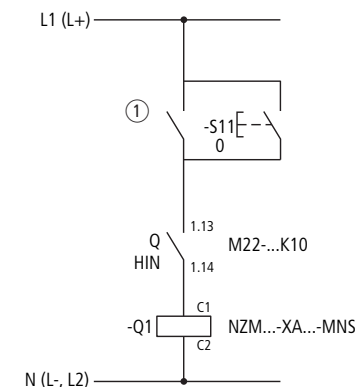
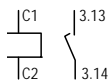

- ① Reverse power relay contact from mesh network relay
- S11 Remote off
- Q Standard auxiliary contacts
- Q1 Shunt releases

### NZM...-XAHIV:

Cannot be used in conjunction with remote operator NZM...-XR....  
NZM3: Early make of auxiliary contact on switching on and off (manual operation): approx. 20 ms.  
NZM4: Early make of auxiliary contact on switching on (manual operation): approx. 90 ms.

# 4.8

## Compact circuit breakers, switch disconnectors

### Shunt releases

#### NZM1, NZM2/3, NZM4

For use with	Rated control voltage	Part no.	Article no.	Std. pack	Notes
	$U_s$	Article no. when ordering separately			
	V				

#### Shunt releases

##### With early-make auxiliary contact

Not in combination with remote operator.

1230PIC-1364 Symbolphoto

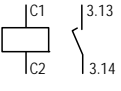

With clamp terminal on left switch side.	NZM1(-4), 12 V AC/DC	NZM1-XAHIV12AC/DC	259772	1 Off	
	N(S)1(-4) 24 V AC/DC	NZM1-XAHIV24AC/DC	259774		
	48 V AC/DC	NZM1-XAHIV48AC/DC	259776		
	60 V AC/DC	NZM1-XAHIV60AC/DC	259778		
	110 V - 130 V AC/DC	NZM1-XAHIV110-130AC/DC	259780		
	208 V - 250 V AC/DC	NZM1-XAHIV208-250AC/DC	259782		
380 V - 440 V AC/DC	NZM1-XAHIV380-440AC/DC	259784			

When the shunt release is live, contact with the switch's main contacts on switching on is reliably prevented. Early make of auxiliary contact on switching on and off (manual operation): approx. 20 ms.

1230PIC-1366 Symbolphoto

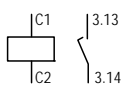

With 3 m connection cable instead of screw terminal	NZM1(-4), 12 V AC/DC	NZM1-XAHIVL12AC/DC	259790	1 Off	
	N(S)1(-4) 24 V AC/DC	NZM1-XAHIVL24AC/DC	259792		
	110 V - 130 V AC/DC	NZM1-XAHIVL110-130AC/DC	259798		
	208 V - 250 V AC/DC	NZM1-XAHIVL208-250AC/DC	259800		
	380 V - 440 V AC/DC	NZM1-XAHIVL380-440AC/DC	259802		

Undervoltage release cannot be installed simultaneously with early-make auxiliary contact NZM...XHIV... or undervoltage release NZM...XU...

1230PIC-1374 Symbolphoto

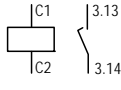

with Screw terminals	NZM2(-4), 12 V AC/DC	NZM2/3-XAHIV12AC/DC	259808	1 Off	
	N(S)2(-4) 24 V AC/DC	NZM2/3-XAHIV24AC/DC	259810		
	NZM3(-4), 48 V AC/DC	NZM2/3-XAHIV48AC/DC	259812		
	N(S)3(-4) 60 V AC/DC	NZM2/3-XAHIV60AC/DC	259814		
	110 V - 130 V AC/DC	NZM2/3-XAHIV110-130AC/DC	259816		
	208 V - 250 V AC/DC	NZM2/3-XAHIV208-250AC/DC	259818		
380 V - 440 V AC/DC	NZM2/3-XAHIV380-440AC/DC	259820			

1230PIC-1388 Symbolphoto

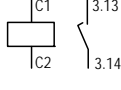

with Screw terminals	NZM4(-4), 12 V AC/DC	NZM4-XAHIV12AC/DC	266470	1 Off	
	N(S)4(-4) 24 V AC/DC	NZM4-XAHIV24AC/DC	266471		
	48 V AC/DC	NZM4-XAHIV48AC/DC	266472		
	60 V AC/DC	NZM4-XAHIV60AC/DC	266473		
	110 V - 130 V AC/DC	NZM4-XAHIV110-130AC/DC	266474		
	208 V - 250 V AC/DC	NZM4-XAHIV208-250AC/DC	266475		
	380 V - 440 V AC/DC	NZM4-XAHIV380-440AC/DC	266476		

When the shunt release is live, contact with the switch's main contacts on switching on is reliably prevented. Early make of auxiliary contact on switching on (manual operation): approx. 90 ms. Cannot be used in conjunction with remote operator NZM...XR.... Undervoltage release cannot be installed simultaneously with early-make auxiliary contact NZM...XHIV... or undervoltage release NZM...XU....

Information relevant for export to North America



Product Standards UL489; CSA-C22.2 No. 5-09; IEC60947, CE marking

UL File No.	E140305
UL CCN	DIHS
CSA File No.	022086
CSA Class No.	1437-01
NA Certification	UL Listed, CSA certified

## Shunt releases NZM2/3, NZM4

For use with	Rated control voltage	Part no.	Article no.	Std. pack	Notes
	$U_s$	Article no. when ordering separately			
	V				

### Shunt releases

#### Without auxiliary contacts - with push in terminal

Instantaneous shut-off of the NZM circuit breaker when the control voltage drops below 35 - 70 %  $U_s$ .  
For use with emergency-stop devices in connection with an emergency-stop button.

wa\_sg07618 Symbolphoto



NZM2(-4), N(S)2(-4)	12 V AC/DC	NZM2/3-XA12AC/DC-PI	189798	1 Off	When the shunt release is live, contact with the circuit breaker's main contacts on switching on is reliably prevented. Shunt release modules cannot be installed simultaneously with early-make contact NZM...-XHIV, undervoltage release NZM...-XU..., or relais modules NZM...-X2A...
NZM3(-4), N(S)3(-4)	24 V AC/DC	NZM2/3-XA24AC/DC-PI	189799		
	48 V AC/DC	NZM2/3-XA48AC/DC-PI	189800		
	60 V AC/DC	NZM2/3-XA60AC/DC-PI	189801		
	110 V - 130 V AC/DC	NZM2/3-XA110-130AC/DC-PI	189802		
	208 V - 250 V AC/DC	NZM2/3-XA208-250AC/DC-PI	189803		

wa\_sg08018 Symbolphoto

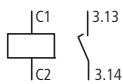

NZM4(-4), N(S)4(-4)	12 V AC/DC	NZM4-XA12AC/DC-PI	189804	
	24 V AC/DC	NZM4-XA24AC/DC-PI	189805	
	48 V AC/DC	NZM4-XA48AC/DC-PI	189806	
	60 V AC/DC	NZM4-XA60AC/DC-PI	189807	
	110 V - 130 V AC/DC	NZM4-XA110-130AC/DC-PI	189808	
	208 V - 250 V AC/DC	NZM4-XA208-250AC/DC-PI	189809	

#### With early-make auxiliary contact - with push in terminal

Instantaneous shut-off of the NZM circuit breaker when the control voltage drops below 35 - 70 %  $U_s$ .  
For use with emergency-stop devices in connection with an emergency-stop button.

wa\_sg07518 Symbolphoto



NZM2(-4), N(S)2(-4), N3(-4)	12 V AC/DC	NZM2/3-XAHIV12AC/DC-PI	189810	1 Off	When the shunt release is live, contact with the circuit breaker's main contacts on switching on is reliably prevented. Early-make of auxiliary contacts on switching on and off (manual operation): approx. 20 ms (NZM2/3) and 90 ms (NZM4). Shunt release modules cannot be installed simultaneously with early-make contact NZM...-XHIV, undervoltage release NZM...-XU..., relais modules NZM...-X2A..., or remote operator NZM...-XR...
	24 V AC/DC	NZM2/3-XAHIV24AC/DC-PI	189811		
	48 V AC/DC	NZM2/3-XAHIV48AC/DC-PI	189812		
	60 V AC/DC	NZM2/3-XAHIV60AC/DC-PI	189813		
	110 V - 130 V AC/DC	NZM2/3-XAHIV110-130AC/DC-PI	189814		
	208 V - 250 V AC/DC	NZM2/3-XAHIV208-250AC/DC-PI	189815		

wa\_sg07818 Symbolphoto

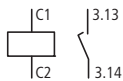

NZM4(-4), N(S)4(-4)	12 V AC/DC	NZM4-XAHIV12AC/DC-PI	189816	
	24 V AC/DC	NZM4-XAHIV24AC/DC-PI	189817	
	48 V AC/DC	NZM4-XAHIV48AC/DC-PI	189818	
	60 V AC/DC	NZM4-XAHIV60AC/DC-PI	189819	
	110 V - 130 V AC/DC	NZM4-XAHIV110-130AC/DC-PI	189820	
	208 V - 250 V AC/DC	NZM4-XAHIV208-250AC/DC-PI	189821	

Information relevant for export to North America



Product Standards	UL489; CSA-C22.2 No. 5-09; IEC60947, CE marking
UL File No.	E140305
UL CCN	DIHS
CSA File No.	022086
CSA Class No.	1437-01
NA Certification	UL Listed, CSA certified

# 4.9

## Compact circuit breakers, switch disconnectors

### Relay modules NZM2/3, NZM4

For use with  
Part no.  
Article no.  
Std. pack  
Notes

Article no. when ordering separately

#### Relay modules

##### Undervoltage releases with two relays

wa\_sg06918 Symbolphoto



For use with	Part no.	Article no.	Std. pack	Notes
PXR20(25)	NZM2/3-XU2A24AC	189724	1 Off	<p>Instantaneous shut-off of the NZM circuit breaker when the control voltage drops below 35 - 70 % U<sub>S</sub>.</p> <p>For use with emergency-stop devices in connection with an emergency-stop button.</p> <p>For signaling commands or different states of the circuit breaker. Two relays per unit.</p> <p>The activation criteria can be configured in the trip unit. Configuration via communication or circuit breaker display or front USB port and Eaton Power Xpert Protection Manager. When the under-voltage trip is switched off, accidental contact with the circuit breaker's primary contacts is prevented when switched on.</p> <p>Only for use in combination with circuit breakers with electronic trips.</p> <p>Under-voltage trip relay modules cannot be installed simultaneously with make-before-break auxiliary contact NZM...-XHIV, under-voltage trip NZM...-XU... or shunt trip NZM...-XA.</p> <p>Relay contacts for control wiring.</p> <p>Control wiring on push-in clamps.</p> <p>Cannot be used with the PXR10 NZM-AX electronic trip.</p>
NZM2(-4)-..X...	NZM2/3-XU2A24DC	189725		
PXR20(25)	NZM2/3-XU2A110-130AC	189726		
NZM3(-4)-..X...	NZM2/3-XU2A208-240AC	189727		

wa\_sg06518 Symbolphoto



For use with	Part no.	Article no.	Std. pack	Notes
PXR20(25)	NZM4-XU2A24AC	189728		<p>Configuration via communication or circuit breaker display or front USB port and Eaton Power Xpert Protection Manager. When the under-voltage trip is switched off, accidental contact with the circuit breaker's primary contacts is prevented when switched on.</p> <p>Only for use in combination with circuit breakers with electronic trips.</p> <p>Under-voltage trip relay modules cannot be installed simultaneously with make-before-break auxiliary contact NZM...-XHIV, under-voltage trip NZM...-XU... or shunt trip NZM...-XA.</p> <p>Relay contacts for control wiring.</p> <p>Control wiring on push-in clamps.</p> <p>Cannot be used with the PXR10 NZM-AX electronic trip.</p>
NZM4(-4)-..X...	NZM4-XU2A24DC	189729		
	NZM4-XU2A110-130AC	189730		
	NZM4-XU2A208-240AC	189731		

sg05318 Symbolphoto



##### Undervoltage releases and 1 early-make auxiliary contact and 2 Relays

For use with	Part no.	Article no.	Std. pack	Notes
PXR20(25)	NZM2/3-XUHIV2A24AC	189732	1 Off	<p>For interlock circuits and load-shedding circuits as well as make-before-break interruption of the shunt trip for primary breaker use.</p> <p>Instantaneous shut-off of the NZM circuit breaker when the control voltage drops below 35 - 70 % U<sub>S</sub>.</p> <p>For use with emergency-stop devices in connection with an emergency-stop button.</p> <p>For signaling commands or different states of the circuit breaker.</p> <p>Two relays per unit.</p> <p>The activation criteria can be configured in the trip unit. Configuration via communication or circuit breaker display or front USB port and Eaton Power Xpert Protection Manager. When the undervoltage trip is switched off, accidental contact with the circuit breaker's primary contacts is prevented when switched on. Make-before-break activation of auxiliary contact when switching on and off (manual operation): approx. 20 ms (NZM2/3) and 90 ms (NZM4). Only for use in combination with circuit breakers with electronic trips. Cannot be used in conjunction with NZM...-XR... remote operator.</p> <p>Undervoltage trip relay modules cannot be installed simultaneously with make-before-break auxiliary contact NZM...-XHIV, undervoltage trip NZM...-XU... or shunt trip NZM...-XA.</p> <p>Relay coil is controlled by trip unit.</p> <p>Relay contacts for control wiring.</p> <p>Control wiring on push-in clamps.</p> <p>Cannot be used with the PXR10 NZM-AX electronic trip.</p>
NZM2(-4)-..X...	NZM2/3-XUHIV2A24DC	189733		
PXR20(25)	NZM2/3-XUHIV2A110-130AC	189734		
NZM3(-4)-..X...	NZM2/3-XUHIV2A208-240AC	189735		

sg05018 Symbolphoto



For use with	Part no.	Article no.	Std. pack	Notes
PXR20(25)	NZM4-XUHIV2A24AC	189736		<p>Configuration via communication or circuit breaker display or front USB port and Eaton Power Xpert Protection Manager. When the undervoltage trip is switched off, accidental contact with the circuit breaker's primary contacts is prevented when switched on. Make-before-break activation of auxiliary contact when switching on and off (manual operation): approx. 20 ms (NZM2/3) and 90 ms (NZM4). Only for use in combination with circuit breakers with electronic trips. Cannot be used in conjunction with NZM...-XR... remote operator.</p> <p>Undervoltage trip relay modules cannot be installed simultaneously with make-before-break auxiliary contact NZM...-XHIV, undervoltage trip NZM...-XU... or shunt trip NZM...-XA.</p> <p>Relay coil is controlled by trip unit.</p> <p>Relay contacts for control wiring.</p> <p>Control wiring on push-in clamps.</p> <p>Cannot be used with the PXR10 NZM-AX electronic trip.</p>
NZM4(-4)-..X...	NZM4-XUHIV2A24DC	189737		
	NZM4-XUHIV2A110-130AC	189738		
	NZM4-XUHIV2A208-240AC	189739		

Information relevant for export to North America



Product Standards	UL489; CSA-C22.2 No. 5-09; IEC60947, CE marking
UL File No.	E140305
UL CCN	DIHS
CSA File No.	022086
CSA Class No.	1437-01
NA Certification	UL Listed, CSA certified



For use with	Part no.	Article no.	Std. pack	Notes
	Article no. when ordering separately			

### Relay modules

#### Shunt release with two relays

wa\_sg06918 Symbolphoto



PXR20(25)	NZM2/3-XA2A24AC	189740	1 Off	
NZM2(-4)-.X...	NZM2/3-XA2A24DC	189741	 	
PXR20(25)	NZM2/3-XA2A110-130AC	189742		
NZM3(-4)-.X...	NZM2/3-XA2A208-240AC	189743		

The breakers are actuated by a voltage pulse or by applying a no-break current.  
For signaling commands or different states of the circuit breaker.  
Two relays per unit.  
The activation criteria can be configured in the trip unit.  
Configuration via communication or circuit breaker display or front USB port and Eaton Power Xpert Protection Manager.  
If the shunt trip is live, contact with the circuit breaker's primary contacts is prevented when switched on.  
Only for use in combination with circuit breakers with electronic trips.  
Shunt trip relay modules cannot be installed simultaneously with make-before-break auxiliary contact NZM...-XHIV, under-voltage trip NZM...-XU... or shunt trip NZM...-XA.  
Relay coil is controlled by trip unit.  
Relay contacts for control wiring.  
Control wiring on push-in clamps.  
Cannot be used with the PXR10 NZM-AX electronic trip.

wa\_sg06518 Symbolphoto



PXR20(25)	NZM4-XA2A24AC	189744		
NZM4(-4)-.X...	NZM4-XA2A24DC	189745		
	NZM4-XA2A110-130AC	189746		
	NZM4-XA2A208-240AC	189747		

#### Relay module

wa\_sg07318 Symbolphoto



PXR20(25)	NZM2/3-X2A	189722	1 Off	
NZM2(-4)-.X...				
PXR20(25)				
NZM3(-4)-.X...				

For signaling commands or different states of the circuit breaker. Two relays per unit. The activation criteria can be configured in the trip unit.  
Configuration via communication or circuit breaker display or front USB port and Eaton Power Xpert Protection Manager.  
24 V DC, 24 - 240 V 50/60 Hz.  
Only for use in combination with circuit breakers with electronic trips.  
Relay components cannot be installed simultaneously with make-before-break auxiliary breaker NZM...-XHIV, the under-voltage trip NZM...-XU... or the shunt trip NZM...-XA....  
Relay contacts for control wiring.  
Control wiring on push-in clamps.  
Cannot be used with the PXR10 NZM-AX electronic trip.

wa\_sg07418 Symbolphoto



PXR20(25)	NZM4-X2A	189723		
NZM4(-4)-.X...				

#### Information relevant for export to North America



Product Standards	UL489; CSA-C22.2 No. 5-09; IEC60947, CE marking
UL File No.	E140305
UL CCN	DIHS
CSA File No.	022086
CSA Class No.	1437-01
NA Certification	UL Listed, CSA certified

# 4.10

## Compact circuit breakers, switch disconnectors

### Door coupling rotary handles NZM1, NZM2, NZM3, NZM4

Product view	For use with	Standard Part no.	Article no.	Std. pack	Notes
		Article no. when ordering separately			

#### Door coupling rotary handles

Complete including rotary drive and coupling parts  
An additional extension shaft is necessary with the NZM...-XT(V)D(V(R))(-60) part numbers.  
Degree of protection IP66/UL/CSA type 4X, 12

#### Standard, black/grey

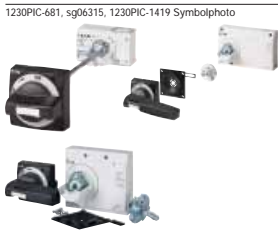

1230PIC-681, sg06315, 1230PIC-1419 Symbolphoto

Lockable in 0 position on handle with up to 3 padlocks. With door interlock	NZM1(-4), PN1(-4), N(S)1(-4)	NZM1-XTVD	260166	1 Off  	Circuit breaker can also be installed in a horizontal position 90° left/right, with the handle still in the same position.
	NZM2(-4), PN2(-4), N(S)2(-4)	NZM2-XTVD	260168		
	NZM3(-4), PN3(-4), N(S)3(-4)	NZM3-XTVD	260170		
	NZM4(-4), N(S)4(-4)	NZM4-XTVD	266614		



1230PIC-681, sg06115, 1230PIC-1419 Symbolphoto

Lockable on handle and switch with up to 3 padlocks. Can be locked in 0 position, with adequate modification also in I position. With door interlock. Lockable on switch in 0 position.	NZM1(-4), PN1(-4), N(S)1(-4)	NZM1-XTVDV	260172		
	NZM2(-4), PN2(-4), N(S)2(-4)	NZM2-XTVDV	260174		
	NZM3(-4), PN3(-4), N(S)3(-4)	NZM3-XTVDV	260176		
	NZM4(-4), N(S)4(-4)	NZM4-XTVDV	266616		

#### Red-yellow for emergency switching off



1230PIC-682, 1230PIC-698, sg05315 Symbolphoto

Lockable on handle and switch with up to 3 padlocks. Lockable in 0 position on handle. With door interlock. Lockable on switch in 0 position.	NZM1(-4), PN1(-4), N(S)1(-4)	NZM1-XTVDVR	260178	1 Off  	Circuit breaker can also be installed in a horizontal position 90° left/right, with the handle still in the same position.
	NZM2(-4), PN2(-4), N(S)2(-4)	NZM2-XTVDVR	260180		
	NZM3(-4), PN3(-4), N(S)3(-4)	NZM3-XTVDVR	260182		
	NZM4(-4), N(S)4(-4)	NZM4-XTVDVR	266618		

#### Information relevant for export to North America



Product Standards	UL489; CSA-C22.2, No. 5-09; IEC60947, CE marking
UL File No.	E140305
UL CCN	DIHS
CSA File No.	022086
CSA Class No.	1437-01
NA Certification	UL Listed, CSA certified
Degree of Protection	IEC: IP66, UL/CSA Type 4X, 12



## Door coupling rotary handles NZM1, NZM2, NZM3, NZM4

For maximum shaft length 60 mm









Part no. Article no. Std. pack Notes

Article no. when  
ordering separately

Extremely narrow fittings

Article no. Std. pack Notes

Article no. when  
ordering separately

Part no.	Article no.	Std. pack	Notes	Part no.	Article no.	Std. pack	Notes		
NZM1-XTVD-60	271504	1 Off	Door interlock <ul style="list-style-type: none"> <li>• Can not be defeated in the locked OFF and ON positions</li> <li>• Can be modified such that it can be defeated from the outside using a screwdriver, when it is in the unlocked ON position.</li> <li>• Door can be opened in OFF NZM...-XTVD(V)-60</li> <li>• For maximum shaft length 60 mm</li> <li>• Without shaft support</li> <li>• Cannot be combined with additional handle NZM...-XDZ</li> <li>• External warning plate/ designation label can be clipped on.</li> </ul>	NZM1-XTVD-0	279392	1 Off	Circuit breaker can also be installed in a horizontal position 90° left/right, with the handle still in the same position.		
NZM2-XTVD-60	271505	 		NZM2-XTVD-0	279393	 			
NZM3-XTVD-60	271506			NZM3-XTVD-0	279394				
NZM4-XTVD-60	271507			NZM4-XTVD-0	279395				
NZM1-XTVDV-60	271508			NZM1-XTVDV-0	279396				
NZM2-XTVDV-60	271509			NZM2-XTVDV-0	279397				
NZM3-XTVDV-60	271510			NZM3-XTVDV-0	279398				
NZM4-XTVDV-60	271511			NZM4-XTVDV-0	279399				
NZM1-XTVDVR-60	271512	1 Off		Door interlock <ul style="list-style-type: none"> <li>• Can not be defeated in the locked OFF position.</li> <li>• Can be modified such that it can be defeated from the outside using a screwdriver, when it is in the unlocked ON position.</li> <li>• Door can be opened in OFF NZM...-XTVDVR-60</li> <li>• For maximum shaft length 60 mm</li> <li>• Without shaft support</li> <li>• Cannot be combined with additional handle NZM...-XDZ</li> <li>• External warning plate/ designation label can be clipped on.</li> </ul>	NZM1-XTVDVR-0	279400		1 Off	Circuit breaker can also be installed in a horizontal position 90° left/right, with the handle still in the same position.
NZM2-XTVDVR-60	271513	 			NZM2-XTVDVR-0	279401		 	
NZM3-XTVDVR-60	271514		NZM3-XTVDVR-0		279402				
NZM4-XTVDVR-60	271515		NZM4-XTVDVR-0		279403				

# 4.10



## Compact circuit breakers, switch disconnectors

Door coupling rotary handles  
 NZM1, NZM2, NZM3, NZM4

For use with	Standard Part no.	Article no.	Std. pack	Notes
	Article no. when ordering separately			

### Extension shaft

UL/CSA certification not required

400 mm max. mounting depth	NZM1(-4), PN1(-4), NZM1/2-XV4 N(S)1(-4) NZM2(-4), PN2(-4), N(S)2(-4)	261232	1 Off  	Length 290 mm, can be cut to required length.
-------------------------------	---	--------	--	--

1230PIC-153 Symbolphoto















NZM3(-4), PN3(-4), NZM3/4-XV4 N(S)3(-4) NZM4(-4), N(S)4(-4)	261234
---	--------

600 mm max. mounting depth	NZM1(-4), PN1(-4), NZM1/2-XV6 N(S)1(-4) NZM2(-4), PN2(-4), N(S)2(-4)	260191	Length 425 mm, can be cut to required length.
-------------------------------	---	--------	--

NZM3(-4), PN3(-4), NZM3/4-XV6 N(S)3(-4) NZM4(-4), N(S)4(-4)	260193
---	--------

## Door coupling rotary handle with key lock NZM1, NZM2, NZM3, NZM4

	For use with	Part no.	Article no.	Std. pack	Notes
<b>Door coupling rotary handle with key lock</b>					
Door coupling rotary handle for operating the switch through a closed control panel door.					
Standard, black/grey					
 <p>1230PIC-1159 Symbolphoto</p>	Lockable in position 0 using cylinder lock and key withdrawable	NZM1(-4), PN1(-4), N(S)1(-4)	NZM1-XTVDKL N(ZM1-XTVDKLR)	172528 172529	1 Off  
	Also possible: lockable on the 0 position on the handle using up to 3 padlocks With door interlock				
 <p>1230PIC-1160 Symbolphoto</p>	Not defeatable in the locked OFF and ON positions with padlock on the handle.	NZM2(-4), PN2(-4), N(S)2(-4)	NZM2-XTVDKL N(ZM2-XTVDKLR)	172530 172531	1 Off  
	Can be modified in the unlocked ON position. Can be modified such that it can be defeated from the outside using a screwdriver.				
 <p>1230PIC-1161 Symbolphoto</p>	Door to be opened in the OFF position when not locked.	NZM3(-4), PN3(-4), N(S)3(-4)	NZM3-XTVDKL N(ZM3-XTVDKLR)	172532 172533	1 Off  
	External warning plate/designation label can be clipped on. Complete including rotary drive and coupling parts.				
 <p>1230PIC-1162 Symbolphoto</p>	Extension shaft additionally required. obtainable in two lengths.	NZM4(-4), N(S)4(-4)	NZM4-XTVDKL N(ZM4-XTVDKLR)	172534 172535	1 Off  

Information relevant for export to North America



Product Standards	UL489; CSA-C22.2 No. 5-09; IEC60947, CE marking
UL File No.	E140305
UL CCN	DIHS
CSA File No.	022086
CSA Class No.	1437-01
NA Certification	UL Listed, CSA certified

# 4.12

## Compact circuit breakers, switch disconnectors

### Door coupling rotary handles for North America NZM1, NZM2, NZM3, NZM4

For use with	Standard Part no.	Article no.	Std. pack	Notes
	Article no. when ordering separately			



#### Door coupling rotary handles

Complete including rotary drive and coupling parts. Extension shaft additionally required. Degree of protection IP66/UL/CSA type 4X, 12. Difference to normal IEC handles: Door opening only possible with active rotation beyond the 0 position.

#### Standard, black/grey

1230PIC-681, sg06315, 1230PIC-1419 Symbolphoto



Lockable in 0 position on handle. With door interlock.	NZM1 N1	NZM1-XTVD-NA	271445	1 Off  	<b>Door interlock</b> <ul style="list-style-type: none"> <li>• Can not be defeated in the locked OFF position.</li> <li>• Door opening with active rotation beyond the 0 position.</li> <li>• Cannot be combined with mechanical interlock</li> <li>• External warning plate/designation label can be clipped on</li> </ul>
	NZM2, N2	NZM2-XTVD-NA	271446		
	NZM3, N3	NZM3-XTVD-NA	271447		
	NZM4, N4	NZM4-XTVD-NA	271448		

1230PIC-681, sg06115, 1230PIC-1419 Symbolphoto



Lockable on handle and switch with up to 3 padlocks. Lockable in 0 position on handle. With door interlock. Lockable on switch in 0 position	NZM1, N(S)1	NZM1-XTVDV-NA	100683		<b>Door interlock</b> <ul style="list-style-type: none"> <li>• Can not be defeated in the locked OFF position.</li> <li>• Door opening possible with active rotation beyond the 0 position. Can be defeated from the outside using a screwdriver.</li> <li>• Cannot be combined with mechanical interlock</li> <li>• External warning plate/designation label can be clipped on.</li> </ul>
	NZM2, N(S)2	NZM2-XTVDV-NA	100684		
	NZM3, N(S)3	NZM3-XTVDV-NA	100685		
	NZM4, N(S)4	NZM4-XTVDV-NA	100686		

#### Red-yellow for emergency switching off

1230PIC-682, 1230PIC-698, sg05315 Symbolphoto



Lockable on handle and switch with up to 3 padlocks. Lockable in 0 position on handle. With door interlock. Lockable on switch in 0 position	NZM1, N(S)1	NZM1-XTVDV-NA	271449	1 Off  	<b>Door interlock</b> <ul style="list-style-type: none"> <li>• Can not be defeated in the locked OFF position.</li> <li>• Door opening with active rotation beyond the 0 position.</li> <li>• Cannot be combined with mechanical interlock</li> <li>• External warning plate/designation label can be clipped on.</li> </ul>
	NZM2, N(S)2	NZM2-XTVDV-NA	271450		
	NZM3, N(S)3	NZM3-XTVDV-NA	271451		
	NZM4, N(S)4	NZM4-XTVDV-NA	271452		

#### Information relevant for export to North America



Product Standards	UL489; CSA-C22.2, No. 5-09; IEC60947, CE marking
UL File No.	E140305
UL CCN	DIHS
CSA File No.	022086
CSA Class No.	1437-01
NA Certification	UL Listed, CSA certified
Degree of Protection	IEC: IP66, UL/CSA Type 4X, 12

## Door coupling rotary handles NZM1, NZM2, NZM3, NZM4





For maximum shaft length 60 mm

Extremely narrow fittings

Part no.	Article no.	Std. pack	Notes	Part no.	Article no.	Std. pack	Notes
----------	-------------	-----------	-------	----------	-------------	-----------	-------

Article no. when ordering separately













Article no. when ordering separately

NZM1-XTVDV-60-NA	100667	1 Off	 <ul style="list-style-type: none"> <li>Door interlock</li> <li>Can not be defeated in the locked OFF position</li> <li>Door opening possible with active rotation beyond the 0 position. Can be defeated from the outside using a screwdriver.</li> </ul>	NZM1-XTVDV-0-NA	100675	1 Off	 <ul style="list-style-type: none"> <li>Door interlock</li> <li>Can not be defeated in the locked OFF position</li> <li>Door opening possible with active rotation beyond the 0 position. Can be defeated from the outside using a screwdriver.</li> </ul>
NZM2-XTVDV-60-NA	100668		<ul style="list-style-type: none"> <li>Cannot be combined with mechanical interlock NZM...-XTVDV-60-NA</li> <li>For a maximum shaft length of 60 mm</li> <li>Without shaft support</li> <li>Cannot be combined with additional handle NZM...-XDZ</li> <li>External warning plate/designation label can be clipped on.</li> </ul>	NZM2-XTVDV-0-NA	100676		<ul style="list-style-type: none"> <li>Cannot be combined with mechanical interlock NZM...-XTVDV-0-NA</li> <li>For extremely narrow fittings</li> <li>With special short extension shaft</li> <li>Cannot be combined with additional handle NZM...-XDZ</li> <li>External warning plate/designation label can be clipped on.</li> </ul>
NZM3-XTVDV-60-NA	100669			NZM3-XTVDV-0-NA	100677		
NZM4-XTVDV-60-NA	100670			NZM4-XTVDV-0-NA	100678		
NZM1-XTVDVR-60-NA	100671	1 Off	 <ul style="list-style-type: none"> <li>Door interlock</li> <li>Can not be defeated in the locked OFF position</li> <li>Door opening possible with active rotation beyond the 0 position. Can be defeated from the outside using a screwdriver.</li> </ul>	NZM1-XTVDVR-0-NA	100679	1 Off	 <ul style="list-style-type: none"> <li>Door interlock</li> <li>Can not be defeated in the locked OFF position</li> <li>Door opening possible with active rotation beyond the 0 position. Can be defeated from the outside using a screwdriver.</li> </ul>
NZM2-XTVDVR-60-NA	100672		<ul style="list-style-type: none"> <li>Door can be opened in OFF NZM...-XTVDVR-60</li> <li>For a maximum shaft length of 60 mm</li> <li>Without shaft support</li> <li>Cannot be combined with additional handle NZM...-XDZ</li> <li>External warning plate/designation label can be clipped on.</li> </ul>	NZM2-XTVDVR-0-NA	100680		<ul style="list-style-type: none"> <li>Door can be opened in OFF NZM...-XTVDVR-0</li> <li>For extremely narrow fittings</li> <li>With special short extension shaft</li> <li>Cannot be combined with additional handle NZM...-XDZ</li> <li>External warning plate/designation label can be clipped on.</li> </ul>
NZM3-XTVDVR-60-NA	100673			NZM3-XTVDVR-0-NA	100681		
NZM4-XTVDVR-60-NA	100674			NZM4-XTVDVR-0-NA	100682		

# 4.13

## Compact circuit breakers, switch disconnectors

### Rotary handles NZM...-XDV

	For use with	Part no.	Article no.	Std. pack	Notes
		Article no. when ordering separately			
<b>Rotary handle on circuit breaker</b>					
Complete with rotary drive					
Standard, black/grey					
 <p>1230PIC-759, 1230PIC-819, sg07015 Symbolphoto</p>	Lockable in 0 position on switch with up to 3 padlocks.	NZM1(-4), PN1(-4), N(S)1(-4)	NZM1-XDV	260125	1 Off   Circuit breaker can also be installed in a lying position 90° left/right, with the handle still in the same position.
		NZM2(-4), PN2(-4), N(S)2(-4)	NZM2-XDV	260127	
		NZM3(-4), PN3(-4), N(S)3(-4)	NZM3-XDV	260129	
		NZM4(-4), N(S)4(-4)	NZM4-XDV	266608	
 <p>1230PIC-760, sg07215, sg07015 Symbolphoto</p>	Lockable in 0 position on handle with up to 3 padlocks.	NZM1(-4), PN1(-4), N(S)1(-4)	NZM1-XDVG	285247	1 Off   Circuit breaker can also be installed in a lying position 90° left/right, with the handle still in the same position.
		NZM2(-4), PN2(-4), N(S)2(-4)	NZM2-XDVG	285248	
		NZM3(-4), PN3(-4), N(S)3(-4)	NZM3-XDVG	165716	
		NZM4(-4), N(S)4(-4)	NZM4-XDVG	165718	
Red-yellow for emergency switch off					
 <p>1230PIC-762, 1230PIC-820, sg07115 Symbolphoto</p>	Lockable in 0 position on switch with up to 3 padlocks.	NZM1(-4), PN1(-4), N(S)1(-4)	NZM1-XDVR	260135	1 Off   Circuit breaker can also be installed in a lying position 90° left/right, with the handle still in the same position.
		NZM2(-4), PN2(-4), N(S)2(-4)	NZM2-XDVR	260137	
		NZM3(-4), PN3(-4), N(S)3(-4)	NZM3-XDVR	260140	
		NZM4(-4), N(S)4(-4)	NZM4-XDVR	266610	
 <p>1230PIC-761, sg07315, sg07115 Symbolphoto</p>	Lockable in 0 position on switch with up to 3 padlocks.	NZM1(-4), PN1(-4), N(S)1(-4)	NZM1-XDVGR	285249	1 Off   Circuit breaker can also be installed in a lying position 90° left/right, with the handle still in the same position.
		NZM2(-4), PN2(-4), N(S)2(-4)	NZM2-XDVGR	285280	
		NZM3(-4), PN3(-4), N(S)3(-4)	NZM3-XDVGR	165717	
		NZM4(-4), N(S)4(-4)	NZM4-XDVGR	165719	

Information relevant for export to North America



Product Standards	UL489; CSA-C22.2, No. 5-09; IEC60947, CE marking
UL File No.	E140305
UL CCN	DIHS
CSA File No.	022086
CSA Class No.	1437-01
NA Certification	UL Listed, CSA certified

## Rotary handles with key lock NZM...XDKL

For use with	Part no.	Article no.	Std. pack	Notes
	Article no. when ordering separately			

### Rotary handles with key lock

Complete with rotary drive

Standard, black/grey

1230PIC-1272 Symbolphoto



Lockable in position 0 using cylinder lock and key withdrawable

NZM1(-4),  
PN1(-4),  
N(S)1(-4)

172536

1 Off



Circuit breaker can also be installed in a lying position 90° left/right, with the handle still in the same position.

Cannot be combined with:

- Remote operator
- Side panel mounting
- Mechan. interlock
- Insulating surround

1230PIC-1273 Symbolphoto



NZM2(-4),  
PN2(-4),  
N(S)2(-4)

NZM2(-4), NZM2-XDKL

172537

1 Off



1230PIC-1274 Symbolphoto



NZM3(-4),  
PN3(-4),  
N(S)3(-4)

NZM3(-4), NZM3-XDKL

172538

1 Off



1230PIC-1275 Symbolphoto



NZM4(-4),  
N(S)4(-4)

NZM4(-4), NZM4-XDKL

172539

Information relevant for export to North America



IP66  
UL/CSA Type 4X, Type 12

# 4.15

## Compact circuit breakers, switch disconnectors

### Rotary handles with door interlock NZM...XDTV

For use with	Part no.	Article no.	Std. pack	Notes
	Article no. when ordering separately			

#### Rotary handles on switch with door interlock

Complete with rotary drive and insulating surround

Standard, black/grey

1230PIC-840 Symbolphoto



Lockable in 0 position on handle with up to 3 padlocks, can also be modified for the I position.

Also available with door interlock e.g. for MCC service distribution.

Red-yellow for emergency switching off

1230PIC-758 Symbolphoto



NZM1(-4), PN1(-4), N(S)1(-4)	NZM1-XDTV	260131	1 Off		Circuit breaker can also be installed in a lying position 90° left/right, with the handle still in the same position.
------------------------------	-----------	--------	-------	--	---

NZM2(-4), PN2(-4), N(S)2(-4)	NZM2-XDTV	260133			
------------------------------	-----------	--------	--	--	--

#### Rotary handles on switch with door interlock for UL/CSA approved NA switches

Difference to normal IEC handles: Door opening only possible with active rotation beyond the 0 position.

Complete with rotary drive and insulating surround

Standard, black/grey

1230PIC-840 Symbolphoto



NZM1, N(S)1	NZM1-XDTV-NA	271453	1 Off		<ul style="list-style-type: none"> <li>Door interlock</li> <li>In the ON position, can be defeated from the outside using a 1 mm pin</li> <li>Can not be defeated in the locked OFF and ON positions</li> <li>Door opening only possible with active rotation beyond the 0 position.</li> <li>Can only be switched ON when the door is closed</li> <li>Cannot be combined with mechanical interlock</li> </ul>
-------------	--------------	--------	-------	--	--

NZM2, N(S)2	NZM2-XDTV-NA	271454			
-------------	--------------	--------	--	--	--

Red-yellow for emergency switching off

1230PIC-758 Symbolphoto



NZM1, N(S)1	NZM1-XDTV-NA	271455	1 Off		<ul style="list-style-type: none"> <li>Circuit breaker can also be installed in a lying position 90° left/right, with the handle still in the same position.</li> </ul>
-------------	--------------	--------	-------	--	---

NZM2, N(S)2	NZM2-XDTV-NA	271456			
-------------	--------------	--------	--	--	--

Information relevant for export to North America



Product Standards	UL489; CSA-C22.2, No. 5-09; IEC60947, CE marking
UL File No.	E140305
UL CCN	DIHS
CSA File No.	022086
CSA Class No.	1437-01
NA Certification	UL Listed, CSA certified



## Main switch assembly kit NZM...XHB..., NZM...-XS...

Model	For use with	Part no.	Article no.	Std. pack
		Article no. when ordering separately		

### Main switch assembly kit

Equipment supplied:

- Door coupling rotary handle
- External warning plate/designation label in German/English
- Extension shaft NZM...-XV4
- Black and yellow flash



For enhanced protection against direct contact on the incomer side, IP2X protection against contact with a finger can be ordered. Other external warning plates/designation labels can be clipped on.

Degree of protection IP66/UL/CSA type 4X, 12.

#### With black door coupling rotary handle

1230PIC-739 Symbolphoto



Lockable in 0 position on handle with up to 3 padlocks, can also be modified for the I position.	-	NZM1(-4) PN1(-4), N(S)1(-4)	NZM1-XHB	266626	1 Off  
With door interlock	-	NZM2(-4) PN2(-4), N(S)2(-4)	NZM2-XHB	266627	
	-	NZM3(-4) PN3(-4), N(S)3(-4)	NZM3-XHB	266628	
	-	NZM4(-4) N(S)4(-4)	NZM4-XHB	271779	

#### With red door coupling rotary handle for use of switch as emergency switching off device to IEC/EN 60204-1

1230PIC-698 Symbolphoto



Lockable in 0 position on handle with up to 3 padlocks.	-	NZM1(-4) PN1(-4), N(S)1(-4)	NZM1-XHBR	266632	
Lockable door as additional feature, locking facility on circuit breaker in 0 position:	-	NZM2(-4) PN2(-4), N(S)2(-4)	NZM2-XHBR	266633	
	-	NZM3(-4) PN3(-4), N(S)3(-4)	NZM3-XHBR	266634	
	-	NZM4(-4) N(S)4(-4)	NZM4-XHBR	271842	

Information relevant for export to North America



Product Standards	UL489; CSA-C22.2, No. 5-09; IEC60947, CE marking
UL File No.	E140305
UL CCN	DIHS
CSA File No.	022086
CSA Class No.	1437-01
NA Certification	UL Listed, CSA certified
Degree of Protection	IEC: IP66, UL/CSA Type 4X, 12

# 4.16

## Compact circuit breakers, switch disconnectors

### Main switch assembly kit NZM...XHB..., NZM...-XS...

Model	For use with	Part no.	Article no.	Std. pack
-------	--------------	----------	-------------	-----------

Article no. when ordering separately

#### Main switch assembly kit

Equipment supplied:

- Door coupling rotary handle
- External warning plate/designation label in German/English
- Extension shaft NZM...-XV4
- Black and yellow flash

For enhanced protection against direct contact on the incomer side, IP2X protection against contact with a finger can be ordered. Other external warning plates/designation labels can be clipped on. Degree of protection IP66/UL/CSA type 4X, 12.

#### For side wall installation

Actuation of the switch on the control panel side wall  
Switch mounting on mounting plate

Standard, black/grey

1230PIC-740 Symbolphoto



Lockable in 0 position on handle with up to 3 padlocks, with adequate modification also in I position.

For operation on the left

NZM1(-4)  
PN1(-4), N(S)1(-4)

NZM1-XS-L

266641

1 Off



NZM2(-4)  
PN2(-4), N(S)2(-4)

NZM2-XS-L

266642

NZM3(-4)  
PN3(-4), N(S)3(-4)

NZM3-XS-L

266643

1230PIC-736 Symbolphoto



For operation on the right

NZM1(-4)  
PN1(-4), N(S)1(-4)

NZM1-XS-R

266644

NZM2(-4)  
PN2(-4), N(S)2(-4)

NZM2-XS-R

266645

NZM3(-4)  
PN3(-4), N(S)3(-4)

NZM3-XS-R

266646

#### Red-yellow for emergency switching off

1230PIC-741 Symbolphoto



Lockable in 0 position on handle with up to 3 padlocks.

For operation on the left

NZM1(-4)  
PN1(-4), N(S)1(-4)

NZM1-XSR-L

266653

1 Off



NZM2(-4)  
PN2(-4), N(S)2(-4)

NZM2-XSR-L

266654

NZM3(-4)  
PN3(-4), N(S)3(-4)

NZM3-XSR-L

266655

1230PIC-737 Symbolphoto



For operation on the right

NZM1(-4)  
PN1(-4), N(S)1(-4)

NZM1-XSR-R

266656

NZM2(-4)  
PN2(-4), N(S)2(-4)

NZM2-XSR-R

266657

NZM3(-4)  
PN3(-4), N(S)3(-4)

NZM3-XSR-R

266658

#### Information relevant for export to North America



Product Standards	UL489; CSA-C22.2, No. 5-09; IEC60947, CE marking
UL File No.	E140305
UL CCN	DIHS
CSA File No.	022086
CSA Class No.	1437-01
NA Certification	UL Listed, CSA certified
Degree of Protection	IEC: IP66, UL/CSA Type 4X, 12

## Main switch assembly kit NZM...XS(R)M...

Model	For use with	Part no.	Article no.	Std. pack	Information relevant for export to North America
		Article no. when ordering separately			

### Main switch assembly kit for side wall installation with mounting bracket

For direct mounting of circuit breaker and handle in the side wall of the control cabinet.

Equipment supplied:

- Door coupling rotary handle
- Special short extension shaft
- External warning plate/designation label in German/English
- Mounting bracket
- Black and yellow flash

For enhanced protection against direct contact on the incomer side, IP2X protection against contact with a finger can be ordered.

Other external warning plates/designation labels can be clipped on.

Degree of protection IP66/UL/CSA type 4X, 12.

Standard, black/grey

1230PIC-727 Symbolphoto



Lockable in 0 position, with adequate modification also in I position. Minimum clearance between control panel side walls and circuit breaker is defined by mounting bracket. Extension cannot be used	For operation on the left	NZM1(-4) PN1(-4), N(S)1(-4)	NZM1-XSM-L	266663	1 Off	Product Standards UL489; CSA-C22.2 No. 5-09; IEC60947, CE marking UL File No. E140305 UL CCN DIHS CSA File No. 022086 CSA Class No. 1437-01 NA Certification UL Listed, CSA certified Degree of Protection IEC: IP66, UL/CSA Type 4X, 12
		NZM2(-4) PN2(-4), N(S)2(-4)	NZM2-XSM-L	266664		
	For operation on the right	NZM1(-4) PN1(-4), N(S)1(-4)	NZM1-XSM-R	266665		
		NZM2(-4) PN2(-4), N(S)2(-4)	NZM2-XSM-R	266666		

Red-yellow for emergency switching off

1230PIC-728 Symbolphoto



Lockable in 0 position on handle. Minimum clearance between control panel side walls and circuitbreaker is defined by mounting bracket. Extension cannot be used.	For operation on the left	NZM1(-4) PN1(-4), N(S)1(-4)	NZM1-XSRM-L	266671	1 Off	Product Standards UL489; CSA-C22.2 No. 5-09; IEC60947, CE marking UL File No. E140305 UL CCN DIHS CSA File No. 022086 CSA Class No. 1437-01 NA Certification UL Listed, CSA certified Degree of Protection IEC: IP66, UL/CSA Type 4X, 12
		NZM2(-4) PN2(-4), N(S)2(-4)	NZM2-XSRM-L	266672		
	For operation on the right	NZM1(-4) PN1(-4), N(S)1(-4)	NZM1-XSRM-R	266673		
		NZM2(-4) PN2(-4), N(S)2(-4)	NZM2-XSRM-R	266674		

### Additional plate

For fitting to the mounting bracket when using neutral conductor or PE conductor terminals K25, K50, K95 or K150.

1230PIC-719 Symbolphoto



-	-	NZM1, NZM1-4, N1, N1-4, PN1, PN1-4, NS1, NZM2, NZM2-4, N2, N2-4, PN2, PN2-4, NS2, NZM1-NA, NZM2-NA	NZM1/2-XZB	266676	1 Off	UL/CSA certification not required
---	---	--	------------	--------	-------	-----------------------------------

# 4.16

## Compact circuit breakers, switch disconnectors

### Main switch assembly kit NZM...XS(R)M...

Model	For use with	Part no.	Article no.	Std. pack	Information relevant for export to North America
		Article no. when ordering separately			

#### Main switch assembly kit with additional rotary handle

Main switch assembly kit with additional rotary handle for switching with opened control panel door.

Equipment supplied:

- Door coupling rotary handle
- Additional rotary handle on switch with "Deliberate Action" operation
- External warning plate/designation label in German/English
- Extension shaft NZM...-XV6 for mounting depth 600 mm, NZM1/2-XV4 with NZM1 for mounting depth 400 mm
- Black and yellow flash

For enhanced protection against direct contact on the incomer side, IP2X protection against contact with a finger can be ordered. Other external warning plates/designation labels can be clipped on.

Degree of protection IP66/UL/CSA type 4X, 12.

With black door coupling rotary handle

1230PIC-899 Symbolphoto



Lockable in 0 position on handle with up to 3 padlocks, can also be modified for the I position. Lockable door as additional feature, locking facility on circuit breaker in 0 position.

1230PIC-1402 Symbolphoto







1230PIC-1300 Symbolphoto



1230PIC-1302 Symbolphoto



Model	For use with	Part no.	Article no.	Std. pack	Information relevant for export to North America
IEC	NZM1(-4) PN1(-4), N1(-4)	NZM1-XHB-DA	125956	1 Off	Product Standards  UL489; CSA-C22.2 No. 5-09; IEC60947, CE marking UL File No. E140305 UL CCN DIHS CSA File No. 022086 CSA Class No. 1437-01 NA Certification UL Listed, CSA certified Degree of Protection IEC: IP66, UL/CSA Type 4X, 12
UL/CSA	NZM1(-4) PN1(-4), N(S)1(-4)	NZM1-XHB-DA-NA	125958		
IEC	NZM2(-4) PN2(-4), N(S)2(-4)	NZM2-XHB-DA	116895		Product Standards  UL489; CSA-C22.2 No. 5-09; IEC60947, CE marking UL File No. E140305 UL CCN DIHS CSA File No. 022086 CSA Class No. 1437-01 NA Certification UL Listed, CSA certified Degree of Protection IEC: IP66, UL/CSA Type 4X, 12
UL/CSA	NZM2(-4) PN2(-4), N(S)2(-4)	NZM2-XHB-DA-NA	116897		
IEC	NZM3(-4) PN3(-4), N(S)3(-4)	NZM3-XHB-DA	118988		Product Standards  UL489; CSA-C22.2 No. 5-09; IEC60947, CE marking UL File No. E140305 UL CCN DIHS CSA File No. 022086 CSA Class No. 1437-01 NA Certification UL Listed, CSA certified Degree of Protection IEC: IP66, UL/CSA Type 4X, 12
UL/CSA	NZM3(-4) PN3(-4), N(S)3(-4)	NZM3-XHB-DA-NA	119000		
IEC	NZM4(-4) PN4(-4), N(S)4(-4)	NZM4-XHB-DA	119002		Product Standards  UL489; CSA-C22.2 No. 5-09; IEC60947, CE marking UL File No. E140305 UL CCN DIHS CSA File No. 022086 CSA Class No. 1437-01 NA Certification UL Listed, CSA certified Degree of Protection IEC: IP66, UL/CSA Type 4X, 12
UL/CSA	NZM4(-4) PN4(-4), N(S)4(-4)	NZM4-XHB-DA-NA	119004		

Information relevant for export to North America



Product Standards	UL489; CSA-C22.2, No. 5-09; IEC60947, CE marking
UL File No.	E140305
UL CCN	DIHS
CSA File No.	022086
CSA Class No.	1437-01
NA Certification	UL Listed, CSA certified
Degree of Protection	IEC: IP66, UL/CSA Type 4X, 12

## Main switch assembly kit NZM...XS(R)M...

Model	For use with	Part no.	Article no.	Std. pack	Information relevant for export to North America
		Article no. when ordering separately			

### Main switch assembly kit with additional rotary handle

Main switch assembly kit with additional rotary handle for switching with opened control panel door.

Equipment supplied:

- Door coupling rotary handle
- Additional rotary handle on switch with "Deliberate Action" operation
- External warning plate/designation label in German/English
- Extension shaft NZM...-XV6 for mounting depth 600 mm, NZM1/2-XV4 with NZM1 for mounting depth 400 mm
- Black and yellow flash

For enhanced protection against direct contact on the incomer side, IP2X protection against contact with a finger can be ordered. Other external warning plates/designation labels can be clipped on.

Degree of protection IP66/UL/CSA type 4X, 12.

With red door coupling rotary handle for use of switch as emergency switching off device

1230PIC-900 Symbolphoto



Lockable in 0 position on handle with up to 3 padlocks.

With door interlock and lockable on switch in 0 position.

IEC	NZM1(-4) PN1(-4), N1(-4)	NZM1-XHB-DAR	125957	1 Off		Product Standards UL489; CSA-C22.2 No. 5-09; IEC60947, CE marking
-----	--------------------------------	--------------	--------	-------	---	--

UL/CSA	NZM1(-4) PN1(-4), N(S)1(-4)	NZM1-XHB-DAR-NA	125959			UL File No. E140305 UL CCN DIHS CSA File No. 022086 CSA Class No. 1437-01 NA Certification UL Listed, CSA certified
--------	-----------------------------------	-----------------	--------	--	--	---

1230PIC-1403 Symbolphoto



IEC	NZM2(-4) PN2(-4), N(S)2(-4)	NZM2-XHB-DAR	116896			Degree of Protection IEC: IP66, UL/CSA Type 4X, 12
-----	-----------------------------------	--------------	--------	--	--	---

UL/CSA	NZM2(-4) PN2(-4), N(S)2(-4)	NZM2-XHB-DAR-NA	116898			
--------	-----------------------------------	-----------------	--------	--	--	--

1230PIC-1301 Symbolphoto



IEC	NZM3(-4) PN3(-4), N(S)3(-4)	NZM3-XHB-DAR	118989			
-----	-----------------------------------	--------------	--------	--	--	--

UL/CSA	NZM3(-4) PN3(-4), N(S)3(-4)	NZM3-XHB-DAR-NA	119001			
--------	-----------------------------------	-----------------	--------	--	--	--

1230PIC-1303 Symbolphoto



IEC	NZM4(-4) PN4(-4), N(S)4(-4)	NZM4-XHB-DAR	119003			
-----	-----------------------------------	--------------	--------	--	--	--

UL/CSA	NZM4(-4) PN4(-4), N(S)4(-4)	NZM4-XHB-DAR-NA	119005			
--------	-----------------------------------	-----------------	--------	--	--	--

Information relevant for export to North America



Product Standards	UL489; CSA-C22.2, No. 5-09; IEC60947, CE marking
UL File No.	E140305
UL CCN	DIHS
CSA File No.	022086
CSA Class No.	1437-01
NA Certification	UL Listed, CSA certified
Degree of Protection	IEC: IP66, UL/CSA Type 4X, 12

# 4.16

## Compact circuit breakers, switch disconnectors

### Accessories

NZM...-XRAV..., ZFS..., BPF...

For use with	Part no.	Article no.	Std. pack	Notes	Information relevant for export to North America
	Article no. when ordering separately				

#### Rear-mounted drives

For direct rear connection of the switch to the side of the control panel or control panel door. Switch actuation on rear through side wall or control panel door. For switch with toggle lever. For enhanced protection against direct contact on the incomer side, IP2X protection against contact with a finger can be ordered. Degree of protection IP66, UL/CSA type 4X, 12.

#### Standard, black/grey

1230PIC-726 Symbolphoto



Lockable in 0 position on handle with up to 3 padlocks.	Part no.	Article no.	Std. pack	Notes	Product Standards
NZM1, N1, NS1, PN1	NZM1-XRAV	107245	1 Off	 External warning plate can be clipped on	UL489; CSA-C22.2 No. 5-09; IEC60947, CE marking
NZM1-4, N1-4, PN1-4	NZM1-4-XRAV	107246			UL File No. E140305 UL CCN DIHS CSA File No. 022086 CSA Class No. 1437-01 NA Certification
NZM2, N2, NS2, PN2	NZM2-XRAV	107247			UL Listed, CSA certified
NZM2-4-XRAV	NZM2-4-XRAV	107248			Degree of Protection IEC: IP66, UL/CSA Type 4X, 12

#### Red-yellow for emergency switching off

Lockable in 0 position on handle with up to 3 padlocks.	Part no.	Article no.	Std. pack	Notes
NZM1, N1, NS1, PN1	NZM1-XRAVR	107249	1 Off	 External warning plate can be clipped on
NZM1-4, N1-4, PN1-4	NZM1-4-XRAVR	107260		
NZM2, N2, NS2, PN2	NZM2-XRAVR	107261		
NZM2-4-XRAVR	NZM2-4-XRAVR	107262		

#### Main switch assembly kit, bottom

External warning plate/designation label can be clipped on. For enhanced busbar tag shroud on the incomer side, please order IP2X protection against contact with a finger. IP66; UL/CSA Type 4X, Type 12.

1230PIC-736 Symbolphoto





UL/CSA, IEC	NZM1-XS-U	110106
-------------	-----------	--------

1230PIC-737 Symbolphoto



UL/CSA, IEC	NZM1-XSR-U	110107
-------------	------------	--------

## Main switch assembly kit with additional handle NZM...-XSH...-NA

For use with	Part no.	Article no.	Std. pack	Notes	Information relevant for export to North America
	Article no. when ordering separately				 

### Main switch assembly kit



External warning plate/designation label can be clipped on.

For enhanced busbar tag shroud on the incomer side, please order IP2X protection against contact with a finger. IP66; UL/CSA Type 4X, Type 12.

Handle black + additional handle black, shaft 600 mm

1230PIC-899 Symbolphoto





NZM1(-4)	NZM1-XHB-DA-V6	144905	1 Off	
PN1(-4), N(S)1(-4)	NZM1-XHB-DA-V6-NA	144906	1 Off	 

Handle red + additional handle red, shaft 600 mm

1230PIC-900 Symbolphoto





NZM1(-4)	NZM1-XHB-DAR-V6	144907	1 Off	
PN1(-4), N(S)1(-4)	NZM1-XHB-DAR-V6-NA	144908	1 Off	 

### Side mounted handle

Complete kit, includes handle, mechanical system, and Bowden cable.

1230PIC-1424 Symbolphoto



UL/CSA Type 4X, Type 12	NZM2...-NA, NS2...-NA	NZM2-XSH-12-48-NA NZM2-XSH-12-84-NA NZM2-XSH-12-120-NA	155482 155483 155484	1 Off	 
----------------------------	-----------------------	--	----------------------------	-------	---

Lockable in the 0 position using up to 3 padlocks on the handle  
For 1 door on an American-style control panel (door plus wide bar next to door)

Caution! Intended exclusively for use outside the scope of application of IEC/EN 60947.

1230PIC-1406 Symbolphoto



	NZM3...-NA, NS3...-NA	NZM3-XSH-12-48-NA NZM3-XSH-12-84-NA NZM3-XSH-12-120-NA	155488 155489 155500		
--	-----------------------	--	----------------------------	--	--



1230PIC-1425 Symbolphoto



	NZM4...-NA, NS4...-NA	NZM4-XSH-12-48-NA NZM4-XSH-12-72-NA NZM4-XSH-12-120-NA	155504 155505 155506		
--	-----------------------	--	----------------------------	--	--

1230PIC-1404 Symbolphoto



UL/CSA Type 4X	NZM2...-NA, NS2...-NA	NZM2-XSH-4X-48-NA NZM2-XSH-4X-84-NA NZM2-XSH-4X-120-NA	155485 155486 155487	1 Off	 
----------------	-----------------------	--	----------------------------	-------	---

Lockable in the 0 position using up to 3 padlocks on the handle  
For 1 door on an American-style control panel (door plus wide bar next to door)

Caution! Intended exclusively for use outside the scope of application of IEC/EN 60947.

1230PIC-1405 Symbolphoto



	NZM3...-NA, NS3...-NA	NZM3-XSH-4X-48-NA NZM3-XSH-4X-84-NA NZM3-XSH-4X-120-NA	155501 155502 155503		
--	-----------------------	--	----------------------------	--	--

1230PIC-1426 Symbolphoto



	NZM4...-NA, NS4...-NA	NZM4-XSH-4X-48-NA NZM4-XSH-4X-72-NA NZM4-XSH-4X-120-NA	155507 155508 155509		
--	-----------------------	--	----------------------------	--	--

# 4.18

## Compact circuit breakers, switch disconnectors

### Remote operators NZM1, NZM2/3, NZM4

For use with	Rated control voltage	Part no.	Article no.	Std. pack	Notes
	$U_s$	Article no. when ordering separately			
	V				

#### Remote operators

For remote switching of circuit breakers and switch disconnectors.  
ON and OFF switching and resetting by means of two-wire or three-wire control.  
Local switching by hand possible.  
Lockable in the 0 position of the remote operator with up to 3 padlocks (hasp thickness: 4 – 8 mm).  
When mounting the remote drive NZM2(3)-XR(D)... on 4 pole switch an additional cover NZM...-XAVPR is required.

#### Closing delay 110 – 170 ms, opening delay 110 – 170 ms

1230PIC-817 Symbolphoto



NZM2(-4)	110 - 130 V 50/60 Hz	NZM2-XRD110-130AC	115390	1 Off	Sliding switch for „Auto“ or „Manual“ Max. number auxiliary contacts: 2 standard auxiliary contacts, 1 trip-indicating auxiliary switches Cannot be combined with switch-disconnector PN... Cannot be combined with mechanical interlock. Do not install M22-CK11(20/02) dual auxiliary contacts in the center auxiliary contact slot in NZM2-XRD.
N(S)2(-4)	208 - 240 V 50/60 Hz	NZM2-XRD208-240AC	115391		
	380 - 440 V 50/60 Hz <sup>1)</sup>	NZM2-XRD380-440AC	115392		
	24 - 30 V DC	NZM2-XRD24-30DC	115393		
	110 - 130 V DC	NZM2-XRD110-130DC	115394		
	220 - 250 V DC	NZM2-XRD220-250DC	115395		

#### Closing delay 60 – 100 ms, opening delay 300 – 3000 ms

1230PIC-769 Symbolphoto



Can be synchronized					
NZM2(-4)	110 - 130 V 50/60 Hz	NZM2-XR110-130AC	259830		Cannot be combined with switch disconnector PN... Dual auxiliary switch M 22-CK11 (20/02) can not be combined with remote operator NZM3-XR...
N(S)2(-4)	208 - 240 V 50/60 Hz	NZM2-XR208-240AC	259832		
	380 - 440 V 50/60 Hz	NZM2-XR380-440AC	259834		
	24 - 30 V DC	NZM2-XR24-30DC	259836		
	48 - 60 V DC	NZM2-XR48-60DC	259838		
	110 - 130 V DC	NZM2-XR110-130DC	259840		
	220 - 250 V DC	NZM2-XR220-250DC	259842		

1230PIC-1434 Symbolphoto



NZM3(-4)	110 - 130 V 50/60 Hz	NZM3-XR110-130AC	259848	
N(S)3(-4)	208 - 240 V 50/60 Hz	NZM3-XR208-240AC	259850	
	380 - 440 V 50/60 Hz	NZM3-XR380-440AC	259852	
	24 - 30 V DC	NZM3-XR24-30DC	259854	
	48 - 60 V DC	NZM3-XR48-60DC	259856	
	110 - 130 V DC	NZM3-XR110-130DC	259858	
	220 - 250 V DC	NZM3-XR220-250DC	259860	

1230PIC-1414 Symbolphoto



NZM4(-4)	110 - 130 V 50/60 Hz	NZM4-XR110-130AC	266684	
N(S)4(-4)	208 - 240 V 50/60 Hz	NZM4-XR208-240AC	266685	
	380 - 440 V 50/60 Hz	NZM4-XR380-440AC	266686	
	24 - 30 V DC	NZM4-XR24-30DC	266691	
	48 - 60 V DC	NZM4-XR48-60DC	266692	
	110 - 130 V DC	NZM4-XR110-130DC	266693	
	220 - 250 V DC	NZM4-XR220-250DC	266694	

Information relevant for export to North America



Product Standards UL489; CSA-C22.2 No. 5-09; IEC60947, CE marking

UL File No. E140305

UL CCN DIHS

CSA File No. 022086

CSA Class No. 1437-01

NA Certification UL Listed, CSA certified



For use with	Part no.	Article no.	Std. pack	Notes
	Article no. when ordering separately			

### Plug screw terminal for remote operator

Plug with screw terminals for remote operator.

wa\_sg06118 Symbolphoto



NZM...-XR...	NZM-XRS	180429	1 Off	
--------------	---------	--------	-------	--

### Cover, 4 pole for remote operator

Additional shroud for mounting the NZM2(3)-XR(D)... on a 4 pole switch is required.

1230PIC-732 Symbolphoto



NZM2-4, N2-4	NZM2-XAVPR	266677	1 Off	-
N2-4...-DC	NZM2-XAVPR-S1-DC	158477		
NZM3-4, N3-4	NZM3-XAVPR	266678	1 Off	
N3-4...-DC	NZM3-XAVPR-S1-DC	158478		

### Sealing device, for NZM2-XRD

Manual operation possible only after removing seal.

1230PIC-1429 Symbolphoto



NZM2(-4) N(S)2(-4)	NZM2-XRDPL	137305	1 Off	Suitable for remote operator NZM2-XRD
-----------------------	------------	--------	-------	---------------------------------------

### Enclosure Cover

Degree of protection IP65  
For increasing the mounting depth by 105 mm  
For switching devices that shall not be operated by laymen  
Transparent  
Also usable for NZM remote operators

v119318\_r Symbolphoto



CI44...	NZM-RTR	194557	1 Off	Width: 265 mm
CI45...				Height: 253 mm
CI48...				

# 4.19

## Compact circuit breakers, switch disconnectors

### Accessories

NZM...-XRAV..., ZFS..., BPF...

Model	For use with	Part no.	Article no.	Std. pack	Notes
-------	--------------	----------	-------------	-----------	-------



Article no. when ordering separately

#### External warning plate/designation label

T15A023 Symbolphoto



Main switch – open in 0 position	german/english	NZM1(-4), PN1(-4),	ZFS61/62-NZM7	272525	10 Off	A bilingual external warning plate/designation label in German/English is already included in the main switch assembly kit.
	german	N(S)1(-4)	ZFS61-NZM7	051089		
	english	NZM2(-4),	ZFS62-NZM7	065957		
	french	PN2(-4),	ZFS63-NZM7	065958		
	chinese/english	N(S)2(-4)	ZFS82-NZM	104910	1 Off	
	chinese	NZM3(-4), PN3(-4),	ZFS83-NZM	105945		
Symbol	Circuit breaker symbol	N(S)3(-4), NZM4(-4),	ZFS-LS-NZM	104829		
	Switch disconnector symbol	N(S)4(-4)	ZFS-LTS-NZM	104828		
	Disconnector symbol		ZFS-TS-NZM	115365		
Blanko	Blank (for engraving or printing)		ZFS60-NZM7	065896	10 Off	

NA main switch – open in 0 position	german/english	NZM1(-4), PN1(-4),	ZFS61/62-NZM-NA	144901	10 Off	A bilingual external warning plate/designation label in German/English is already included in the main switch assembly kit.
	english	N(S)1(-4)	ZFS62-NZM-NA	144902	 	
	english/spanish	NZM2(-4),	ZFS62/77-NZM-NA	144903		
	english/french	PN2(-4), N(S)2(-4),	ZFS62/63-NZM-NA	144904		
		NZM3(-4), PN3(-4), N(S)3(-4), NZM4(-4), N(S)4(-4)				

#### Lightning symbol

Including terminal marking for main switch

T230PIC-294 Symbolphoto



small	NZM1(-4), PN1(-4), N(S)1(-4), NZM2(-4), PN2(-4), N(S)2(-4)	BPF-NZM7	217294	10 Off	Included as standard in main switch assembly kit. Marking of the input side of the switch is possible.
large	NZM3(-4), PN3(-4), N(S)3(-4), NZM4(-4), N(S)4(-4)	BPF-NZM10	231363		

For use with	Part no.	Article no.	Std. pack	Notes	Information relevant for export to North America
	Article no. when ordering separately				

#### Additional handle

Enables switching when control panel door is open

1230PIC-753 Symbolphoto



NZM1(-4), PN1(-4), N(S)1(-4) NZM2(-4), PN2(-4), N(S)2(-4)	NZM1/2-XDZ	266621	1 Off		Push-fits on to the extension shaft. 100 mm free extension shaft required. Cannot be combined with door coupling rotary handles	Product Standards UL489; CSA-C22.2 No. 5-09; IEC60947, CE marking E140305	UL File No. E140305 UL CCN DIHS
NZM3(-4), PN3(-4), N(S)3(-4) NZM4(-4), N(S)4(-4)	NZM3/4-XDZ	266622			NZM...-XT...-60 or NZM...-XT...0.	UL File No. E140305 UL CCN DIHS CSA File No. 022086 CSA Class No. 1437-01 NA Certification UL Listed, CSA certified	

#### Insulating surround

For toggle levers, rotary handles with rotary drive and remote operators. Degree of protection IP40

1230PIC-679 Symbolphoto



NZM1(-4), PN1(-4), N(S)1(-4)	NZM1-XBR	260195	1 Off		For rectangular cut-out on doors and enclosures with material thicknesses of 1.5 – 5 mm. External warning plate/designation label can be clipped on. NZM4-XBR can not be combined with rotary handle with NZM2(-4) rotary mechanism	Product Standards UL489; CSA-C22.2 No. 5-09; IEC60947, CE marking E140305	UL File No. E140305 UL CCN DIHS CSA File No. 022086 CSA Class No. 1437-01 NA Certification UL Listed, CSA certified
NZM2(-4), PN2(-4), N(S)2(-4)	NZM2-XBR	260197					
NZM3(-4), PN3(-4), N(S)3(-4)	NZM3-XBR	284645					
NZM4(-4), N(S)4(-4)	NZM4-XBR	284646					

1230PIC-691 Symbolphoto



For toggle lever, narrow. Degree of protection IP40

1230PIC-722 Symbolphoto



NZM1(-4), PN1(-4), N(S)1(-4)	NZM1-XBRS	115274			For rectangular cutouts on doors and enclosures with a material thickness of 1 - 3 mm.	Product Standards UL489; CSA-C22.2 No. 5-09; IEC60947, CE marking E140305	UL File No. E140305 UL CCN DIHS
NZM2(-4), PN2(-4), N(S)2(-4) PN3(-4), N(S)3(-4)	NZM2/3-XBRS	115275			Clip-in external warning plate/marketing plate. Switches with slim insulating surrounds can be placed in a row next to each other. The required minimum clearance must be observed when doing so	UL File No. E140305 UL CCN DIHS CSA File No. 022086 CSA Class No. 1437-01 NA Certification UL Listed, CSA certified	
NZM4(-4), N(S)4(-4)	NZM4-XBRS	115277					

#### Toggle lever locking device

Lockable in Off position with up to three padlocks (hasp thickness 4 – 8 mm).

sg00711 Symbolphoto



NZM1(-4), NZM1(-1), PN1(-4), N(S)1(-4)	NZM1-XKAV	260199	1 Off		Cannot be combined with insulating surround.	Product Standards UL489; CSA-C22.2 No. 5-09; IEC60947, CE marking E140305	UL File No. E140305 UL CCN DIHS
NZM2(-4), PN2(-4), N(S)2(-4) NZM3(-4), PN3(-4), N(S)3(-4)	NZM2/3-XKAV	260201				UL File No. E140305 UL CCN DIHS CSA File No. 022086 CSA Class No. 1437-01 NA Certification UL Listed, CSA certified	

1230PIC-684 Symbolphoto



# 4.19

## Compact circuit breakers, switch disconnectors

### Accessories

NZM...-XDZ, NZM...-XBR, NZM...-X...

For use with	Part no.	Article no.	Std. pack	Notes	Information relevant for export to North America
	Article no. when ordering separately				

#### Spacers

Enables fast and attractively priced offsetting of varying construction sizes with/without rotary handle or remote operator to the same front depth.

1230PIC-717 Symbolphoto



NZM1(-4), PN1(-4), N(S)1(-4), NZM2(-4), PN2(-4), N(S)2(-4)	NZM1/2-XAB	260203	1 Off 	Grid depth 17.5 mm, M4 thread One set contains 4 spacers Maximum component fitting: NZM1: 4 off per fixing screw, NZM2: 2 off per fixing screw, 2 (NZM1) or 4 (NZM2) fixing screws contained per switch	Product Standards UL489; CSA-C22.2 No. 5-09; IEC60947, CE marking UL File No. UL CCN CSA File No. CSA Class No. NA Certification E140305 DIHS 022086 1437-01 UL Listed, CSA certified
---	------------	--------	--	--	--

NZM3(-4), PN3(-4), N(S)3(-4), NZM4(-4), N(S)4(-4)	NZM3-XAB	260211	1 Off 	Grid depth 17.5 mm, M5 thread One set contains 4 spacers NZM3, NZM4: 1 off per fixing screw 4 fixing screws per switch included	
---	----------	--------	--	---	--

#### Clips

Allows switches to be clipped onto DIN rails.

1230PIC-723 Symbolphoto



NZM1(-4), PN1(-4), N(S)1(-4)	NZM1-XC35	260213	1 Off 	For 35 mm top-hat rails. Cannot be combined with plug-in units	Product Standards UL489; CSA-C22.2 No. 5-09; IEC60947, CE marking
NZM2(-4), PN2(-4), N(S)2(-4)	NZM2-XC75	260215		For 75 mm top-hat rails.. Cannot be combined with remote operator and plug-in units.	UL File No. UL CCN CSA File No. CSA Class No. NA Certification E140305 DIHS 022086 1437-01 UL Listed, CSA certified

## Mechanical interlock NZM...XMV(R)(L), NZM-XBZ...

For use with	Part no.	Article no.	Std. pack	Notes	Information relevant for export to North America
	Article no. when ordering separately				

### Mechanical interlock for (door coupling) rotary handles

1230PIC-766 Symbolphoto



NZM1(-4) NZM1-XMV  
PN1(-4),  
N(S)1(-4)

281581



Cannot be combined with NZM...-XTV...-NA door coupling rotary handles.

Product Standards

UL489;  
CSA-C22.2  
No. 5-09;  
IEC60947,  
CE marking

UL File No.

E140305

UL CCN

DIHS

CSA File No.

022086

CSA Class No.1437-01

NA Certification

UL Listed,  
CSA certified

At least 2 interlock modules are required in order to assemble a mechanical interlock.

Possible combinations and interlock versions Engineering  
Order Bowden cable separately

sg07515 Symbolphoto



NZM2(-4) NZM2-XMV  
PN2(-4),  
N(S)2(-4)

281582

sg07415 Symbolphoto



NZM3(-4) NZM3-XMV  
PN3(-4),  
N(S)3(-4)

281583

sg07415 Symbolphoto



NZM4(-4) NZM4-XMV  
N(S)4(-4)

281584

### Bowden cables

For mechanical interlock for (door coupling) rotary handles

1230PIC-807 Symbolphoto



Length: 225 mm NZM1(-4), NZM-XBZ225  
PN1(-4),

281585



Selection and combinations of Bowden cables

Product Standards

UL489;  
CSA-C22.2  
No. 5-09;  
IEC60947,  
CE marking

Length: 600 mm N(S)1(-4), NZM2(-4),  
PN2(-4),

281586

Length: 1000 mm N(S)2(-4), NZM3(-4),  
PN3(-4),

281587

UL File No.

E140305

UL CCN

DIHS

CSA File No.

022086

CSA Class No.1437-01

NA Certification

UL Listed,  
CSA certified

N(S)3(-4),

NZM4(-4),

N(S)4(-4)

# 4.20/21

## Compact circuit breakers, switch disconnectors

Mechanical interlock / Paralleling mechanism  
 NZM...XMV(R)(L), NZM-XBZ...

For use with	Part no.	Article no.	Std. pack	Notes
	Article no. when ordering separately			

Information relevant for export to North America



### Mechanical interlock for remote operator

For 2 switches of the same or different construction size with opposed operation. Adjacent mounting.

1230PIC-734 Symbolphoto



NZM2(-4), N(S)2(-4) +NZM2(-4), N(S)2(-4)	NZM2-XMVR	104543	1 Off	Contains parts for both switch sides. - Extension shaft additionally required. Maximum switch spacing Can not be combined with rotary handles, door coupling rotary handles, early-make auxiliary contacts, and direct- switching remote operator NZM2-XRD.
NZM2(-4), N(S)2(-4) +NZM3(-4), N(S)3(-4)	NZM2/3-XMVR	104544		
NZM3(-4), N(S)3(-4) +NZM3(-4), N(S)3(-4)	NZM3-XMVR	104545		
NZM3(-4), N(S)3(-4) +NZM4(-4), N(S)4(-4)	NZM3/4-XMVR	104546		
NZM4(-4), N(S)4(-4) +NZM4(-4), N(S)4(-4)	NZM4-XMVR	104547		

For 2 switches of the same or different construction size with opposed operation.

Extra long Bowden cable for mounting one above the other or in adjacent enclosures.

NZM2(-4), N(S)2(-4) +NZM2(-4), N(S)2(-4)	NZM2-XMVRL	104548	1 Off	Contains parts for both switch sides. - Extension shaft additionally required. Maximum switch spacing Can not be combined with rotary handles, door coupling rotary handles, early-make auxiliary contacts, and direct- switching remote operator NZM2-XRD.
NZM2(-4), N(S)2(-4) +NZM3(-4), N(S)3(-4)	NZM2/3-XMVRL	104549		
NZM3(-4), N(S)3(-4) +NZM3(-4), N(S)3(-4)	NZM3-XMVRL	104550		
NZM3(-4), N(S)3(-4) +NZM4(-4), N(S)4(-4)	NZM3/4-XMVRL	104551		
NZM4(-4), N(S)4(-4) +NZM4(-4), N(S)4(-4)	NZM4-XMVRL	104552		

### Paralleling mechanism

Simultaneous actuation of 2 PN switch disconnectors of the same type mounted side-by-side.

1230PIC-749 Symbolphoto



PN1(-4) + PN1(-4)	PN1-XPA	283471	1 Off	<b>PN1, PN2</b> • 1 x rotary handle on circuit (-XD) supplied. • 1 x door coupling rotary handle (-XTVD) supplied.	Not UL/CSA approved
PN2(-4) + PN2(-4)	PN2-XPA	283472			

1230PIC-750 Symbolphoto



PN3(-4) + PN3(-4)	PN3-XPA	283473		<b>PN3</b> • 1 x rotary handle on switch (not lockable) supplied. • 1 x door coupling rotary handle (not lockable) supplied. • Not suitable for use as a main switch.
----------------------	---------	--------	--	---

Number of poles	Rated current = Rated uninterrupted current	Setting range			Part no.	Article no.	Std. pack
		Overload releases	Short-circuit releases delayed	Short-circuit releases Non-delayed			
	$I_n = I_u$ A	$I_r = I_n \times \dots$ A	$I_{sd} = I_r \times \dots$	$I_r = I_n \times \dots$			

### Circuit breakers with earth-fault release, 3 pole For apparatus with power electronics, such as power inverters and frequency inverters



AC/DC sensitive according to core-balance principle in range of 0 – 100 kHz residual-current frequency. Not UL/CSA approved.

Suitable for use in three-phase systems.

Rated operating voltage: 400 V (50/60 Hz)

Rated fault current  $I_{\Delta n} = 0.03$  A

Internal power supply  $U_g = 50 - 400$  V

Turnkey combination of current-limiting circuit breaker and residual-current device.

Adjusting buttons can be sealed.

Depending on the cable manufacturer up to 240 mm<sup>2</sup> can be connected.

### High switching capacity 150 kA; 415 V 50/60 Hz

1230PIC-1421 Symbolphoto



3 pole	Rated current (A)	Overload releases (A)	Short-circuit releases delayed (A)	Short-circuit releases non-delayed (A)	Part no.	Article no.	Std. pack
	100	80 - 100	600 - 1000	6 - 10	NZMH2-A100-FIA30	158530	1 Off
	125	100 - 125	750...1250	6 - 10	NZMH2-A125-FIA30	129710	
	160	125 - 160	960...1600	6 - 10	NZMH2-A160-FIA30	112627	
	200	160 - 200	1200...2000	6 - 10	NZMH2-A200-FIA30	112628	
	250	200 - 250	1500...2500	6 - 10	NZMH2-A250-FIA30	112629	
	100	80 - 100	600 - 1000	6 - 10	NZMH2-A100-FIA30-BT	158531	
	125	100 - 125	750...1250	6 - 10	NZMH2-A125-FIA30-BT	129711	
	160	125 - 160	960...1600	6 - 10	NZMH2-A160-FIA30-BT	116304	
	200	160 - 200	1200...2000	6 - 10	NZMH2-A200-FIA30-BT	116305	
	250	200 - 250	1500...2500	6 - 10	NZMH2-A250-FIA30-BT	116306	
	100	80 - 100	600 - 1000	6 - 10	NZMH2-A100-FIA30-500AC	184959	
	125	100 - 125	750...1250	6 - 10	NZMH2-A125-FIA30-500AC	184960	
	160	125 - 160	960...1600	6 - 10	NZMH2-A160-FIA30-500AC	184961	
	200	160 - 200	1200...2000	6 - 10	NZMH2-A200-FIA30-500AC	184962	
	250	200 - 250	1500...2500	6 - 10	NZMH2-A250-FIA30-500AC	184963	

# 4.22

## Compact circuit breakers, switch disconnectors

### Earth-fault release NZM...XFI...

For use with	Number of conductors	Part no. Article no. when ordering separately	Article no.	Std. pack	Notes
--------------	----------------------	--	-------------	-----------	-------

#### Earth-fault release

To IEC/EN 60947-2

Not UL/CSA approved

Suitable for use in three- and single-phase systems

Pulse-current sensitive according to core-balance principle 

For 3 and 4 pole NZM1(-4) circuit breakers and N1(-4)

Switch disconnectors, dependant on mains power  $U_b = 200 \dots 415 \text{ V } 50/60 \text{ Hz}$

#### Mounting on right side up to $I_n = 160 \text{ A}$ at $I_{Cu} = 50 \text{ kA}$

1230PIC-799 Symbolphoto



Rated fault current $I_{\Delta n} = 0.03 \text{ A}$	NZM1	3 pole	NZM1-XFI30R	104603	1 Off
	N(S)1				

NZM1-4	4 pole	NZM1-4-XFI30R	104606
N1-4			

1230PIC-864 Symbolphoto



Rated fault current $I_{\Delta n} = 0.3 \text{ A}$	NZM1	3 pole	NZM1-XFI300R	104604
	N(S)1			

NZM1-4	4 pole	NZM1-4-XFI300R	104607
N1-4			

1230PIC-841 Symbolphoto



Rated fault current $I_{\Delta n} = 0.03 - 0.1 - 0.3 - 0.5 - 1 - 3 \text{ A}$	NZM1	3 pole	NZM1-XFIR	104605
	N(S)1			

Delay time $t_v = 10 - 60 - 150 - 300 - 450 \text{ ms}$	NZM1-4	4 pole	NZM1-4-XFIR	104608
	N1-4			

1230PIC-865 Symbolphoto



Rated fault current $I_{\Delta n} = 0.03 \text{ A}$	NZM1	3 pole	NZM1-XFI30U	104609	1 Off
	N(S)1				

NZM1-4	4 pole	NZM1-4-XFI30U	104612
N1-4			

1230PIC-896 Symbolphoto



Rated fault current $I_{\Delta n} = 0.3 \text{ A}$	NZM1	3 pole	NZM1-XFI300U	104610
	N(S)1			

NZM1-4	4 pole	NZM1-4-XFI300U	104613
N1-4			

1230PIC-755 Symbolphoto



Rated fault current $I_{\Delta n} = 0.03 - 0.1 - 0.3 - 0.5 - 1 - 3 \text{ A}$	NZM1	3 pole	NZM1-XFIU	104611
	N(S)1			

Delay time $t_v = 10 - 60 - 150 - 300 - 450 \text{ ms}$	NZM1-4	4 pole	NZM1-4-XFIU	104614
	N1-4			

At  $I_{\Delta n} = 0.03 \text{ A}$ : delay time  $t_v$  always fixed at 10 ms.  
Alarm indication  $> 30 \% I_{\Delta n}$  by yellow LED.  
Trip indication by up to 2 auxiliary contacts (HIAFI) can be retrofitted:  
N/O = M22-K01, NC = M22-K10 are reset with the reset toggle lever.  
If the trip-indicating auxiliary contact in the fault current block is used, the NC contacts operates as a N/O contact and the NC contact operates as N/O contacts. Double contact not permissible.  
Not in combination with insulated enclosure or main switch assembly kit for side wall installation with mounting bracket.  
NZM1-XFI...R can not be used in combination with lower cover NZM1-XKSA.  
NZM1-XFI...U not in combination with shunt or undervoltage release, early-make auxiliary contacts.  
Rated ultimate short-circuit breaking capacity is determined by the fitted NZM1 or NS1, or, if a switch disconnector N1 is used, by the fitted back-up fuse.  
Technical data.  
Adjusting buttons can be sealed.



For use with	Part no.	Article no.	Std. pack	Notes
	Article no. when ordering separately			

### Power supply module, 24 VDC

24 V DC supply to the electronic trip.

wa\_sg06318 Symbolphoto



NZM2(-4)-VX(MX)...	NZM2-XPS24DC	189822	1 Off	Mechanical pass-through of the switch's status (I, O) for use by the remote operator.
NZM3(-4)-VX(MX)...	NZM3-XPS24DC	189823		
NZM4(-4)-VX(MX)...	NZM4-XPS24DC	189824		

### Interface module, PXR20, connection for communication

For universal connection of optional circuit breaker functions. Required for communication. The connection types depend on the design of the interface module. Circuit breaker status detection (I, +, O) for the electronic trip unit. The switch's status can be communicated. 24 V DC auxiliary power connection. Connection for Communications Adapter Module (CAM). Optional CAM available for various Fieldbus communication systems (Profibus DP, SmartWire-DT, Ethernet-based Fieldbus). Connection to optional, internal Modbus RTU module.

wa\_sg06318 Symbolphoto



NZM2(-4)-VX(MX)(PX)(PMX)...	NZM2-XBSM	189825	1 Off	Mechanical pass-through of the switch's status (I, O) for use by the remote operator.
NZM3(-4)-VX(MX)(PX)(PMX)...	NZM3-XBSM	189826		
NZM4(-4)-VX(MX)..., NZM4-4-PX(PMX)...	NZM4-XBSM	189827		Connection to neutral voltage Vn. Mechanical pass-through of the switch's status (I, O) for use by the remote operator
NZM4-PX(PMX)...	NZM4-XBSM-N	189830		

### Interface module, PXR25, connection for communication, zone selectivity, ARMS

For universal connection of optional circuit breaker functions. Required for communication. The connection types depend on the design of the interface module. Circuit breaker status detection (I, +, O) for the electronic trip unit. The switch's status can be communicated. 24 V DC auxiliary power connection. Connection for Communications Adapter Module (CAM). Optional CAM available for various Fieldbus communication systems (Profibus DP, SmartWire-DT, Ethernet-based Fieldbus). Connection to optional, internal Modbus RTU module. Connector for Logical Zone Selectivity (ZSI) function. Mechanical pass-through of the switch's status (I, O) for use by the remote operator.

sg05118 Symbolphoto



NZM2(-4)-PX...-TZ	NZM2-XBSM-TZ	189832	1 Off	Connection for maintenance mode (ARMS).
NZM3(-4)-PX...-TAZ	NZM3-XBSM-TAZ	189833		
NZM4-4-PX...-TAZ	NZM4-XBSM-TAZ	189835		Connection to neutral voltage Vn. Connection for maintenance mode (ARMS).
NZM4-PX...-TAZ	NZM4-XBSM-TAZ-N	189834		

# 4.24

## Compact circuit breakers, switch disconnectors

### Communication module NZM...

For use with	Part no.	Article no.	Std. pack	Notes
	Article no. when ordering separately			

#### Internal communication module

For the Fieldbus connection. The module is mounted in the right hand accessory pocket of the circuit breaker.  
For connection to Modbus RTU. RS485 interface.

sg05218



NZM2(3)(4)(-4)-VX(MX)(PX)(PMX)	PXR-RCAM-MRTU-I	189836	1 Off	Cannot be used with the PXR10 NZM-AX electronic trip.
--------------------------------	-----------------	--------	-------	---

#### Communication module

For Fieldbus connection to the IZMX and NZM circuit breakers.  
The module is mounted externally near the circuit breaker.

sg04818, wa\_sg06218



NZM2(3)(4)(-4)-VX(MX)(PX)(PMX) IZMX...	PXR-PCAM	195565	1 Off	Connection to Profibus DP Cannot be used with the PXR10 NZM-AX electronic trip.
NZM2(3)(4)(-4)-VX(MX)(PX)(PMX) IZMX...	PXR-ECAM-MTCP	195566		For connection to Modbus TCP. Cannot be used with the PXR10 NZM-AX electronic trip.

#### Connection cable

PXR-...CAM...	PXR-XCAM-NZMCABLE	195905	1 Off	For fieldbus connection to NZM circuit breakers. The connecting cable is mounted between the NZM and the external communication module. Connection to NZM prefabricated. Connection to CAM open. Length 3 m. Can be shortened as needed.
---------------	-------------------	--------	-------	--

Max. Rated Operational Current $I_e$ (A)	Rated Operational Voltage $U_e$ (V)	Adapter Width (mm)	Adapter Length (mm)	Special Features	For use with	Notes	Part no.	Article no.	Std. pack (Stk.)
---	--	-----------------------	------------------------	------------------	--------------	-------	----------	-------------	------------------

### NZM Busbar Adapter, 3-pole

#### Busbar Adapter NZM

- For use on flat copper bars 12 - 30 x 5/10, Double-T-Profiles and Triple-T-Profiles.
- Self-extinguishing according to UL 94.
- Track resistance CTI 200.
- Temperature-resistant up to 120 °C.

1230PIC-668 AO



160	690	92	200	For connecting to the system at the top or bottom through fixed connection bars included in the scope of delivery. <sup>1)2)</sup>	NZM1 N1 NS1	For switches with standard frame-type terminals. To be snapped onto the busbar by means of a combi-base.	NZM1-XAD160	104554	1
-----	-----	----	-----	--	-------------------	--	-------------	--------	---

wa\_vt12213



250	690	106	190	For connecting to the system at the top/bottom through a tube-type of connection at the rear. Tube included in the scope of delivery. <sup>3)</sup>	NZM2 N2 NS2	Use only in combination with auxiliary type (+)NZM2-XKR4. To be screwed onto the busbar by means of a clawtype of clamp.	NZM2-XAD250	104555	1
-----	-----	-----	-----	---	-------------------	--	-------------	--------	---

wa\_vt22513, wa\_vt12213



630	690	140	300	For connecting to the system at the top/bottom through a tube-type of connection at the rear. Tube included in the scope of delivery. <sup>3)</sup>	NZM3 N3	Use only in combination with auxiliary type (+)NZM3-XKR13. To be screwed onto the busbar by means of a claw-type of clamp.	NZM3-XAD630	107206	1
-----	-----	-----	-----	---	------------	--	-------------	--------	---

#### Terminal for Device Adapter NZM

wa\_vt12713



250	690	–	–	To cover the connection to the system at the top/bottom.	NZM2 PN2 N2 NS2	For device combination NZM2 use with auxiliary type +NZM2-XKR40 or +NZM2- XKR4U.	NZM2-XKR4	281666	1
-----	-----	---	---	--	--------------------------	--	-----------	--------	---

wa\_vt12613



630	690	–	–	To cover the connection to the system at the top/bottom.	NZM3 PN3 N3	For device combination NZM3 use with auxiliary type +NZM3- XKR130 or +NZM3-XKR13U.	NZM3-XKR13	281668	1
-----	-----	---	---	--	-------------------	--	------------	--------	---

<sup>1)</sup> To be snapped onto the voltage-free busbar.

<sup>2)</sup> Thanks to the combi-base it can be adjusted to a bar width of both 5 and 10 mm.

<sup>3)</sup> To be screwed onto the voltage-free busbar.

# 4.25

## SASY 60i Busbar System

### NZM Busbar Adapter, 4-pole

Max. Rated Operational Current $I_e$ (A)	Rated Operational Voltage $U_e$ (V)	Adapter Width (mm)	Adapter Length (mm)	Special Features	For use with	Notes	Part no.	Article no.	Std. pack (Stk.)
---	--	-----------------------	------------------------	------------------	--------------	-------	----------	-------------	------------------

#### NZM Busbar Adapter, 4-pole

##### Busbar Adapter NZM

- For use on fl at copper bars 12 - 30 x 5/10, Double-T-Profiles and Triple-T-Profiles.
- Self-extinguishing according to UL 94.
- Track resistance CTI 200.
- Temperature-resistant up to 120 °C.

01063591\_0



250	690	140	–	For connecting to the system at the top through a tubetype of connection at the rear. Tube included in the scope of delivery. <sup>3)</sup>	NZM2(-4) PN2(-4) N2(-4) NS2(-4)	Use only in combination with auxiliary type (+)NZM2-4-XKR4. To be screwed onto the busbar by means of a claw-type of clamp.	NZM2-4-XAD250	138388	1
-----	-----	-----	---	---	--	---	---------------	--------	---

01063598\_0



630	690	185	–	For connecting to the system at the top through a tubetype of connection at the rear. Tube included in the scope of delivery. <sup>3)</sup>	NZM3(-4) PN3(-4) N3(-4) NS3(-4)	Use only in combination with auxiliary type (+)NZM3-4-XKR13. To be screwed onto the busbar by means of a clawtype of clamp.	NZM3-4-XAD630	138389	1
-----	-----	-----	---	---	--	---	---------------	--------	---

##### Terminal for Device Adapter NZM

NZM2-4-XKR4



250	690	–	–	To cover the connection to the system at the top.	NZM2-4 PN2-4 N2-4 NS2-4	For device combination NZM2 use with auxiliary type +NZM2-4-XKR40.	NZM2-4-XKR4	118907	1
-----	-----	---	---	---	----------------------------------	--	-------------	--------	---

NZM2-4-XKR4



630	690	–	–	To cover the connection to the system at the top.	NZM3-4 PN3-4 N3-4 NS3-4	For device combination NZM3 use with auxiliary type +NZM3-4-XKR130.	NZM3-4-XKR13	119020	1
-----	-----	---	---	---	----------------------------------	---	--------------	--------	---

<sup>1)</sup> To be snapped onto the voltage-free busbar.

<sup>2)</sup> Thanks to the combi-base it can be adjusted to a bar width of both 5 and 10 mm, cross-section of conductor 6 x 9 x 0.8.

<sup>3)</sup> To be screwed onto the voltage-free busbar.

### Busbar Adapter NZM

	NZM1-XAD160	NZM2-XAD250	NZM3-XAD630
Design	3-pole, 690 V~	3-pole, 690 V~	3-pole, 690 V~
Bar system	60 mm	60 mm	60 mm
Bar contacting	combi-base	claw-type terminal	claw-type terminal
Connection of the switchgear	top/bottom	top or bottom	top or bottom
Short circuit current rating SCCR	32 kA at 480 V	35 kA at 480 V 50 kA at 600 V	65 kA at 480 V 50 kA at 600 V

#### NZM1-XAD160

Base body:

Thermoplastic

Temperature resistant up to 120 °C

Self-extinguishing according to UL 94

Track resistance CTI 200

Halogen-free

Derating:

Ambient temperature	25	30	35	40	45	50	55
Permissible rated current	160	155	150	146	141	136	130
Derating to 160 A	1	0.97	0.94	0.91	0.88	0.85	0.81

#### NZM2-XAD250

Base body:

Thermoplastic

Temperature resistant up to 120 °C

Self-extinguishing according to UL 94

Track resistance CTI 200

Halogen-free

#### NZM3-XAD630

Base body:

Thermoplastic

Temperature resistant up to 120 °C

Self-extinguishing according to UL 94

Track resistance CTI 200

Halogen-free

Derating:

Ambient temperature	20	30	40	50	60	65	70
Permissible rated current	630	605	580	554	529	517	504
Derating to 630 A	1	0.96	0.92	0.88	0.84	0.82	0.80

Notes:

Please observe the de-rating coefficients listed in the table above to determine the maximum ampacity allowed at different ambient temperatures!

Example:

An NZM3...3...630... device with an NZM3-XAD630 device adapter should be operated at an ambient temperature of 50 °C.

Question:

What is the maximum rated operating current  $I_b$  allowed  $I_b$  ? =>

Solution:

At an ambient temperature of 50 °C, the de-rating coefficient is 0.88. This means that  $I_b = 630 \text{ A} \times 0.88 = 544 \text{ A}$ .

At an ambient temperature of 50 °C, the device can therefore be operated at a maximum of  $I_b = 544 \text{ A}$ .

# 5.1

## Compact circuit breakers, switch disconnectors

Construction size 1: Basic devices  
 NZM1, PN1, N1, NS1

### Dimensions (mm)

#### 3 pole

- NZMB1
- NZMC1
- NZMN1
- NZMH1
- PN1
- N1
- NS1

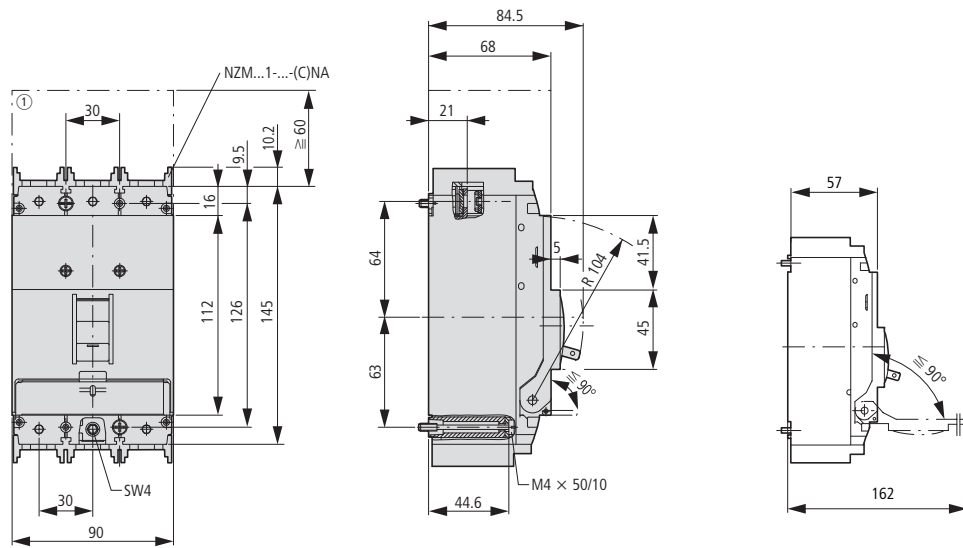

① Blow-out area, minimum distance to other parts  $\geq 60$  mm

#### 4 pole

- NZMB1-4
- NZMC1-4
- NZMN1-4
- NZMH1-4
- PN1-4
- N1-4

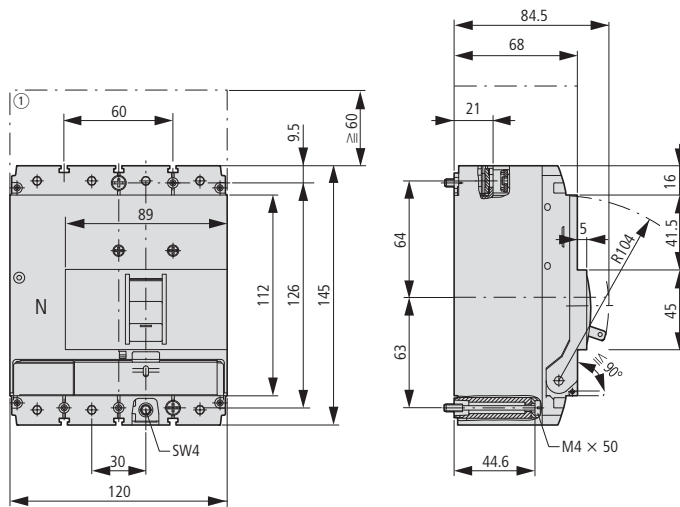

① Blow-out area, minimum distance to other parts  $\geq 60$  mm

## Dimensions (mm)

### 3 pole

NZMB2  
NZMC2  
NZMN2  
NZMH2  
PN2  
N2  
NS2

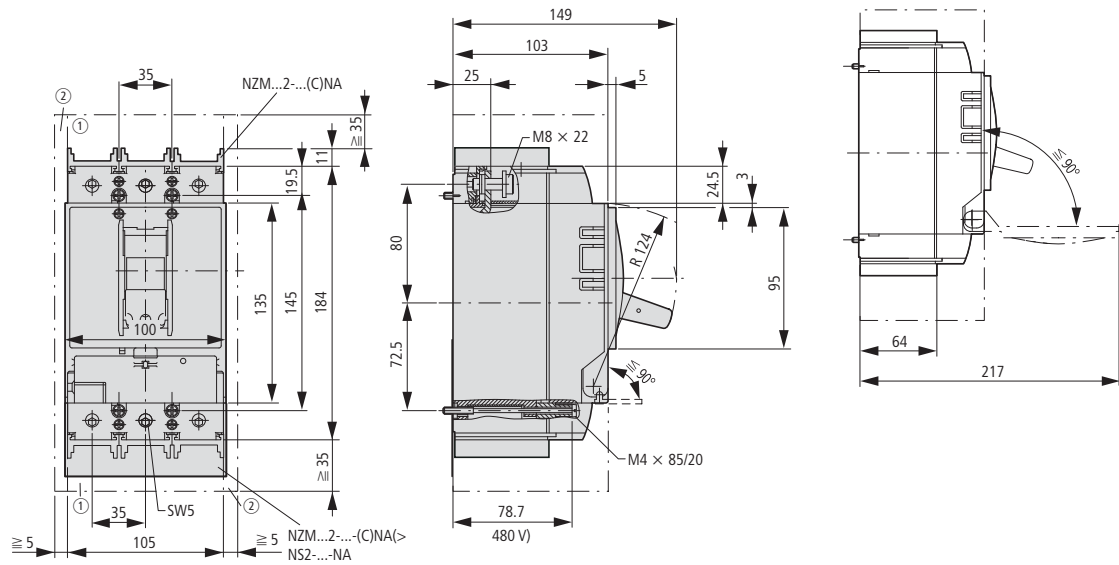

- ① Blow-out area, minimum distance to other parts  $\geq 35$  mm
- ② Minimum distance to adjacent parts  $\geq 5$  mm

### 4 pole

NZMB2-4  
NZMC2-4  
NZMN2-4  
NZMH2-4  
PN2-4  
N2-4

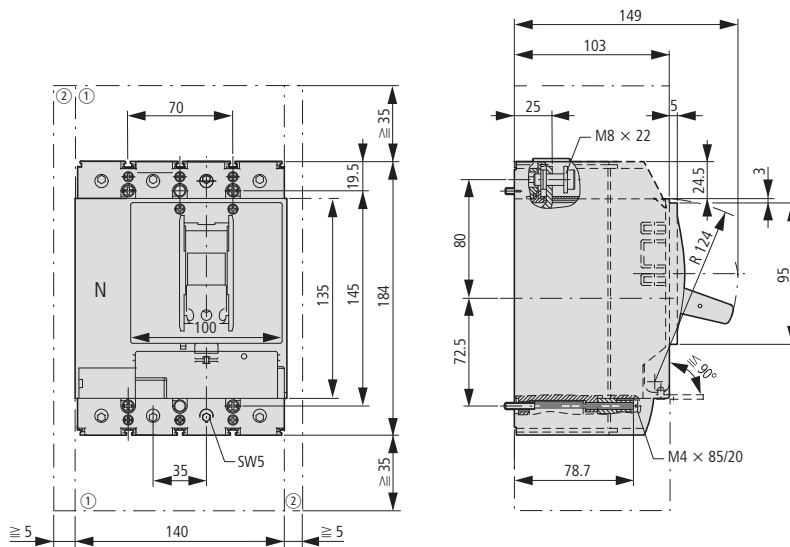

- ① Blow-out area, minimum distance to other parts  $\geq 35$  mm
- ② Minimum distance to adjacent parts  $\geq 5$  mm

# 5.3

## Compact circuit breakers, switch disconnectors

Construction size 3: Basic devices  
 NZM3, PN3, N3, NS3

### Dimensions (mm)

#### 3 pole

NZMC3  
 PN3  
 N3  
 NS3

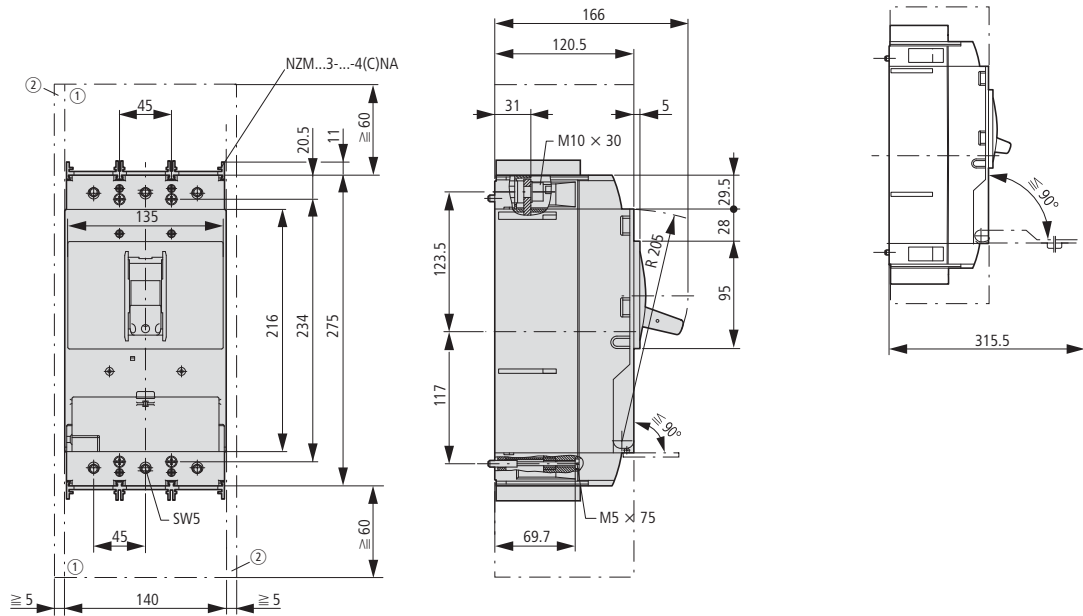

- ① Blow-out area, minimum distance to other parts  $\geq 60$  mm
- ② Minimum distance to adjacent parts  $\geq 5$  mm

#### 4 pole

NZMC3-4  
 NZMN3-4  
 NZMH3-4  
 PN3-4  
 N3-4

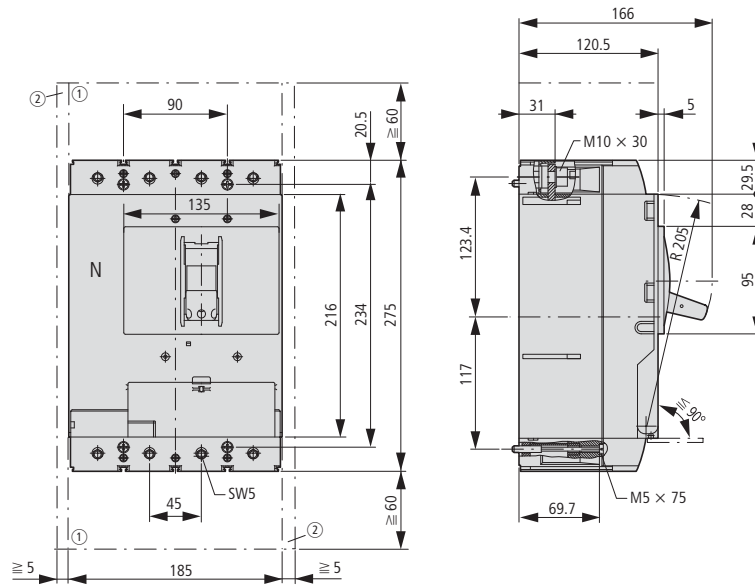

- ① Blow-out area, minimum distance to other parts  $\geq 60$  mm
- ② Minimum distance to adjacent parts  $\geq 5$  mm



## Dimensions (mm)

### 3 pole

NZMN4  
NZMH4  
N4  
NS4

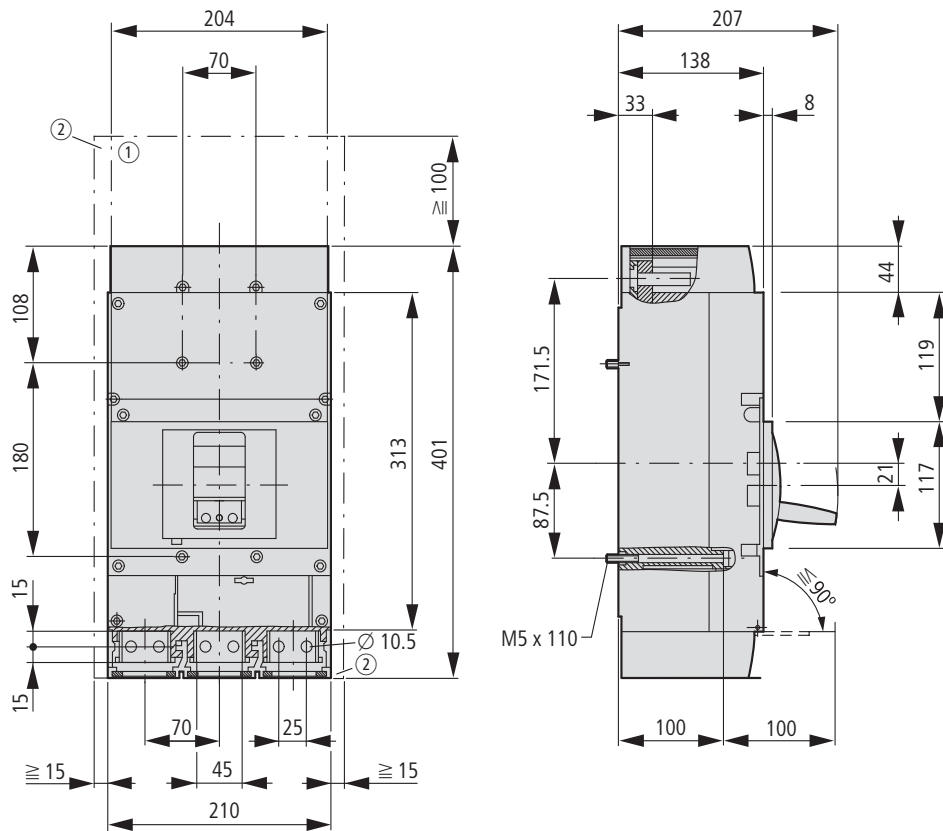

- ① Blow-out area, minimum distance to other parts  $\geq 100$  mm up to 690 V;  $\geq 200$  mm up to 1000 V
- ② Minimum distance to adjacent parts  $\geq 15$  mm

### 4 pole

NZMN4-4  
NZMH4-4  
N4-4

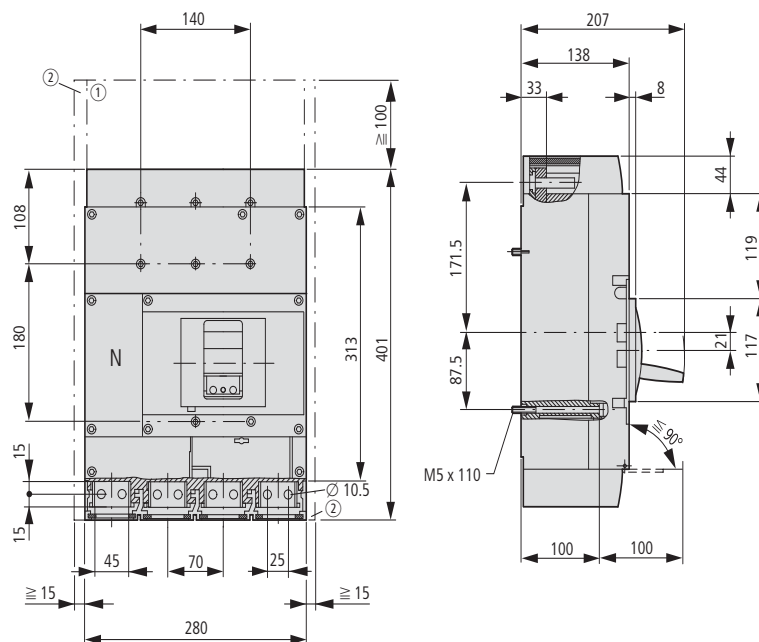

- ① Blow-out area, minimum distance to other parts  $\geq 100$  mm
- ② Minimum distance to adjacent parts  $\geq 15$  mm

# Our flip catalog: Get information, select, order – the fast and easy way!



This product overview is designed as a quick selection aid for our core range of machine building products. And to make it even more powerful, we have an online version with comprehensive extra features available: our digital flip catalog. The result? Getting information and placing orders is easier and faster than ever before.

How does our digital flip catalog work? Easy: Its contents are linked to the Eaton online catalog and to the relevant product pages on the Internet, meaning that clicking on a part number or article number will take you directly to all the pertinent product information. In other words, the flip catalog is the perfect way to obtain comprehensive, up-to-date information, perfectly complementing our hard copy catalog.

# Explore our flip catalog and its powerful features

## Our full range of products and our product pages only a mouse click away

Often you need more than just the items in our core range of products. This is why the pages in the flip catalog feature deep links to relevant accessories, products with expanded performance ranges, and additional product versions. And when it comes to introduction pages with general information on a product, the deep link function will take you to the relevant detailed product pages on the Internet.

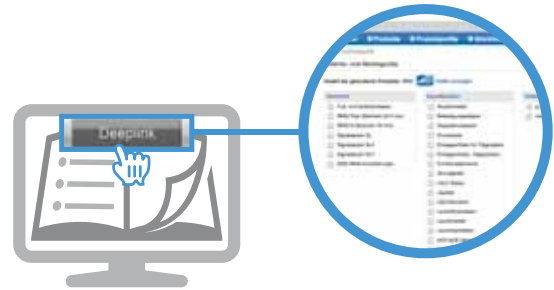

## Technical data at a glance

Clicking on a product will show the corresponding data sheet with all technical data and dimensional drawings. In addition, you can use the available options to access CAD data, trip characteristics, manuals, instruction leaflets, and other information.



## Easily generate parts lists and place orders

You can use the flip catalog to select products and group them together in a parts list. This parts list can then be used together with the online catalog to request quotations, place orders, or to obtain required documentation.



## The InfoPlus icon: your access to more information

Clicking on the InfoPlus icon will show additional information such as configurators, selection aids, software, tutorial videos, technical essays, and Internet pages. This information ensures that you will get a comprehensive view that perfectly complements our product overview for machinery.



## Up-to-date information on the entire range of products in the online catalog

More than 25,000 data sheets, extensive selection aids, and up-to-date product information in a variety of languages – all in our online catalog: [www.eaton.eu/ecat](http://www.eaton.eu/ecat).



# xSpider

## xSpider creates your networks

The xSpider software is a graphic-oriented design system for dimensioning of low-voltage networks fitted with Eaton brand circuit protection equipment.

The software is intended primarily for designers and computational engineers. It includes a new graphics and computing core as well as a new user interface.

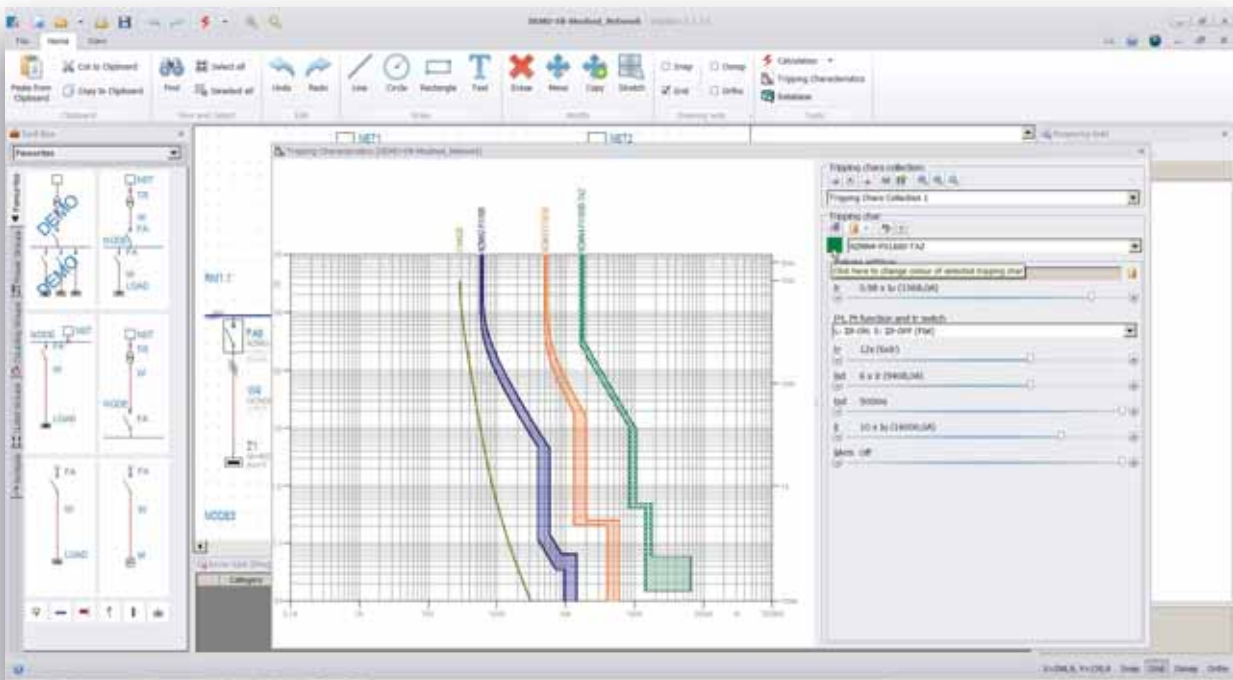

## General Features

- Suitable for TN / IT / TT network systems of different voltage systems up to 1,000 V.
- Design of radial as well as meshed networks.
- Operating status manager for simulating various operating states of the network (ON/OFF status of sources and loads).
- Database of components with transparent tree structure, allowing user-defined additions.
- All calculations are based on IEC standards.
- Coordination of protective devices (selectivity, backup protection).
- Tripping characteristics available for all protective devices.
- Generation of documentation (wiring diagram with calculation results, calculation report etc.).

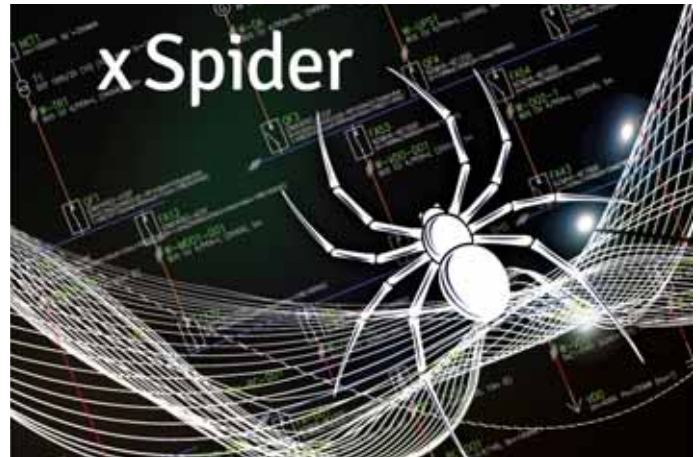

## Calculations

- **Voltage drops** in nodal points of the network.
- Load distribution in the network lines.
- Power factor calculation for meshed networks.
- **Three-phase symmetric short circuit** according to IEC 60909.
- Backup protection – checking the breaking capacities of the out-going protective components at the outgoers.
- Selectivity assessment of circuit breakers according to tripping characteristics and selectivity tables.
- **Single-phase asymmetrical short circuit current.**
- Calculation of the disconnection time and check on compliance with the requirements of IEC 60364-4-41.

## Displaying of results

- Calculation is followed by a display of the list of non-compliant elements (in parallel with the wiring diagram).
- After the calculation has been performed, the calculated values will be displayed for the individual components in the network wiring diagram.
- The results diagram is printable. It can be printed on any output device, for which a driver is available in Windows (printer, plotter).
- After calculation, a comprehensive report on the calculation can be generated and printed.

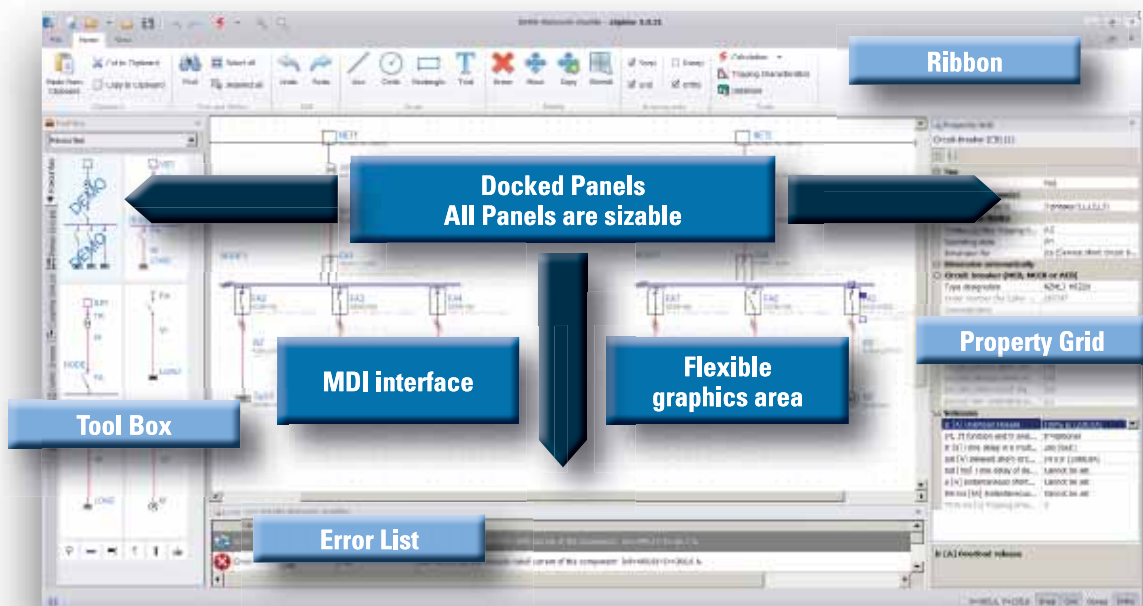

User operation similar to standard CAD systems (AutoCAD)

## Working with tripping characteristics

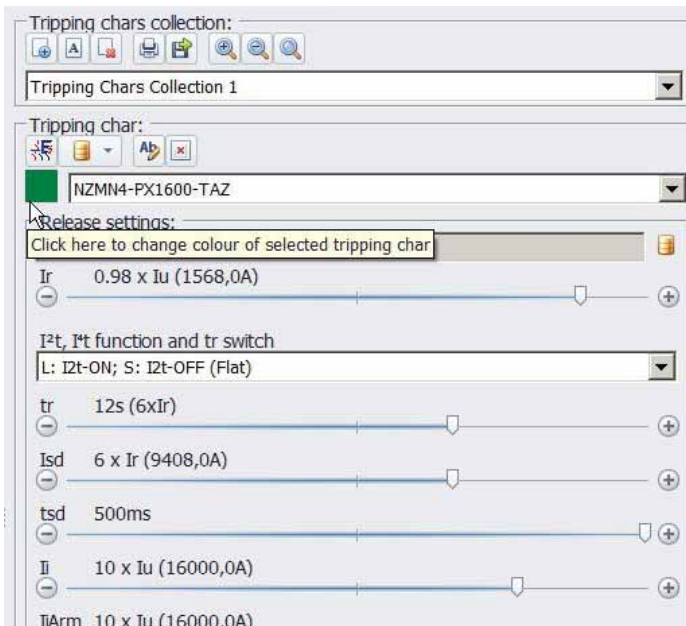

Setting of parameters for selected circuit breaker tripping characteristic

- The dialogue box with the tripping characteristics is shown in parallel with the wiring diagram.
- Selection of a protective device from the database and rendering of its tripping characteristic (including tolerance range if the necessary data is available).
- Selection of protective equipment from the network wiring diagram and drawing of its tripping characteristics – selectivity assessment possible.
- If a circuit protection device is equipped with adjustable releases, it is possible to modify all available parameters. If this was a device from the wiring diagram, the change of the release parameter setting is transferred back into the wiring diagram.
- It is also possible to work with the tripping characteristics independently, i.e. without drawing a wiring diagram.

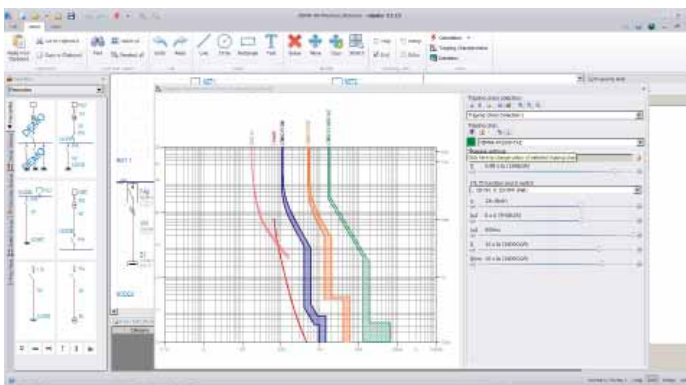

Tripping characteristic of NZM breakers

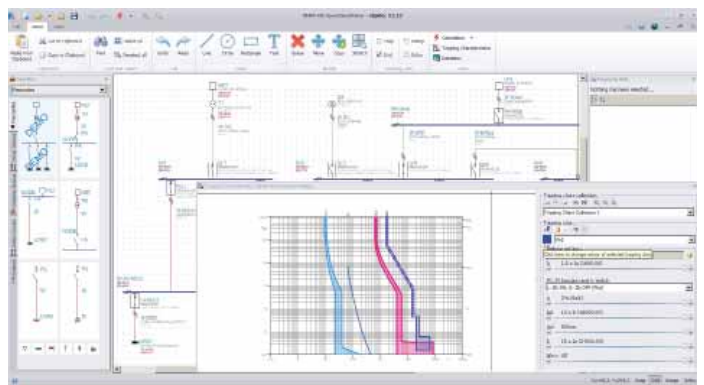

Tripping characteristic of NZM4 with activated Arc Reduction Maintenance System (ARMS)

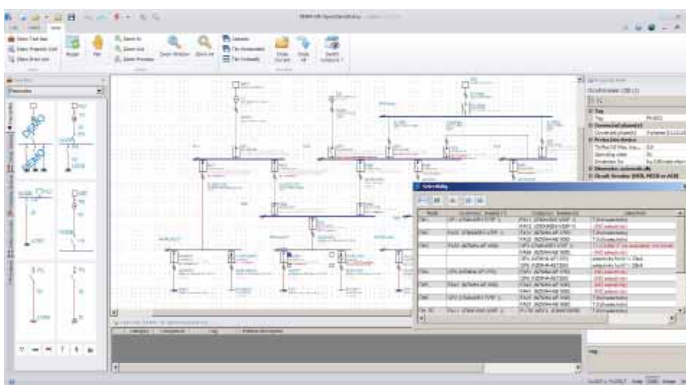

Complex evaluation of selectivity and backup protection

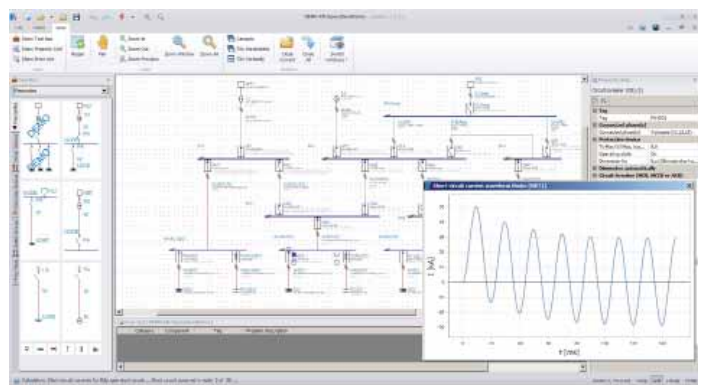

Tripping characteristic of NZM breakers with complex evaluation of selectivity and backup protection in the project

## How to obtain the xSpider software

Go to the xSpider homepage: 1) [www.eaton.eu/xspider](http://www.eaton.eu/xspider)  
2) Search with any explorer (Google) for terms such as: xSpider, or xSpider Eaton etc.

- Download the xSpider software \*)
- Installation of xSpider to a computer
- xSpider icon is displayed on the screen – click on it
- Start

\*) available also:

- PowerPoint presentations – quick overview of features
- User manual is part of installation or available separately as a PDF file
- Instruction videos help to quickly understand operation.



## How to start the first job

The most effective way for quick learning is to start with the selected "DEMO Network" drawing, then look at Videos and follow the User manual, Part III.

### 1 DEMO drawing

Ready drawings with explanation of basic features. The DEMO drawing contains all basic components and allows immediate work with all xSpider features.

### 2 Videos

Typical situations in the everyday use of xSpider

### 3 User manual

Step-by-step explanation in Part III:  
Part I: Theoretical Introduction  
Part II: Program Operation  
Part III: Solved Examples



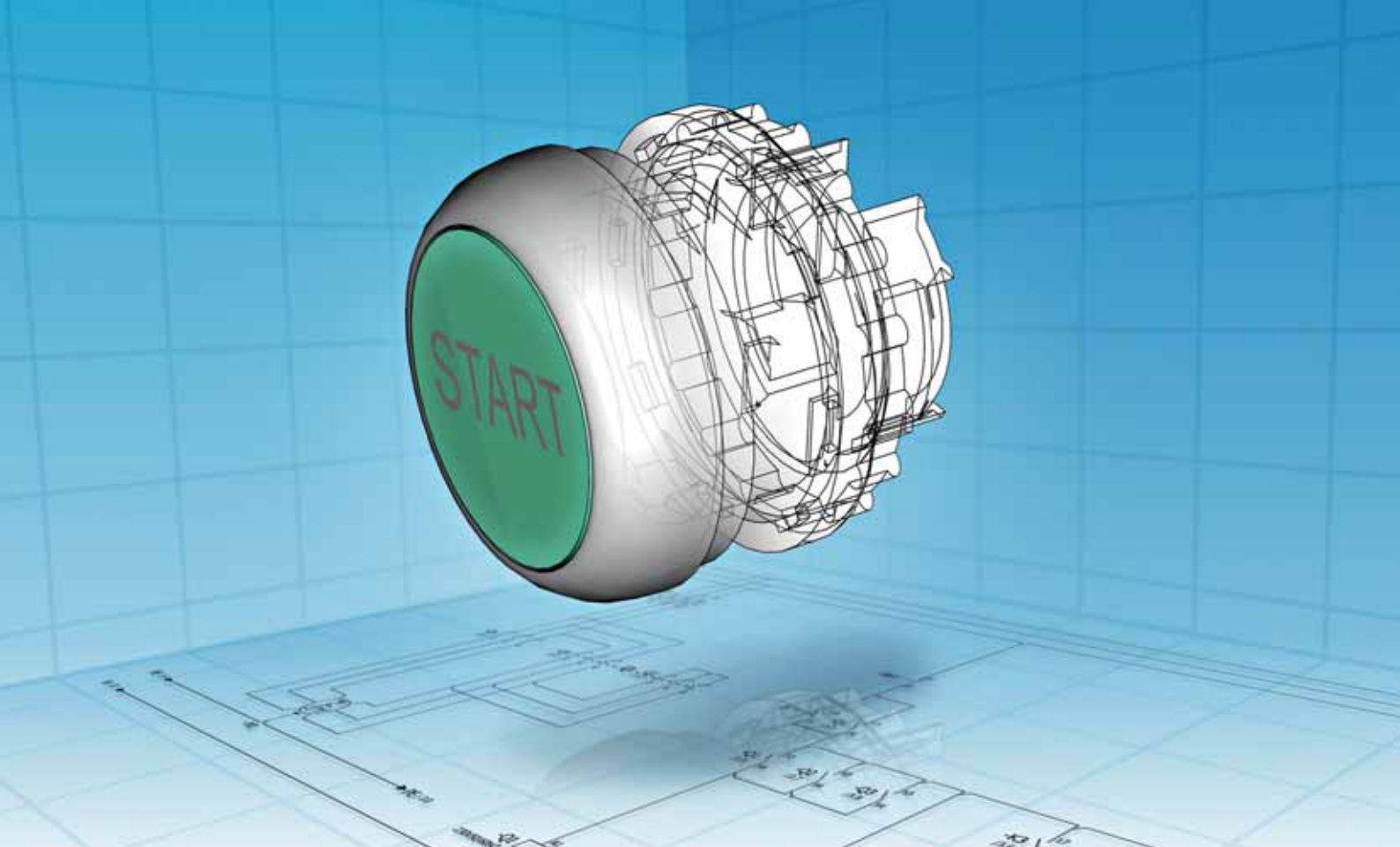

# Planning safety and process optimization: CAD data at the click of a mouse!



- 13,200 article data items and macros
- Convenient selection tool
- Version P8



- Models for approx. 11,000 products
- 80 different neutral & native formats

Eaton is providing its customers with CAD data to offer optimum support during planning. Both electrical and mechanical design data can be called up quickly and conveniently from the Internet at any time. This reduces processing times, minimizes errors and thus already reduces costs in the engineering phase of control panels, systems and machinery.

**eCAD:** Eaton has product data and macros available for EPLAN Electric P8. After downloading the small EPLANSelection program, you will not only be able to select the items you need from a database containing more than 10,800 products, but will also be able to export and import them into your own EPLAN item database.

**mCAD:** Eaton makes 2D and 3D data available for more than 11,000 products. Over 80 different neutral and native formats guarantee compatibility with the project engineering systems of the customer. The models can either be integrated directly into the planning software from the PARTcommunity Portal on the Internet or via the CADENAS PARTsolution software.





We make what matters work.\*

\* At Eaton, we believe that power is a fundamental part of just about everything people do. That's why we're dedicated to helping our customers find new ways to manage electrical, hydraulic and mechanical power more efficiently, safely and sustainably. To improve people's lives, the communities where we live and work, and the planet our future generations depend upon. Because this is what really matters. And we're here to make sure it works.

**To learn more go to: [Eaton.com/whatmatters](https://www.eaton.com/whatmatters)**

**We make what matters work.**

Build it in.



# XV HMI/PLC: Systematic visualization and control



All devices can also be used in portrait format

With the XV HMI-PLC touch panels Eaton offers customers in the machine and system building sector a systematically coordinated range that can be perfectly integrated into different performance classes.

The smart integration of the PLC runtime into a slim and efficient embedded platform strategy in combination with powerful processors creates a state of the art, scalable and cost-efficient automation concept.

The use of the CODESYS programming standard, together with a comprehensive range of ports and interfaces and the ability to use over 100 protocols as an HMI, demonstrates the system's open nature.

Display sizes from 3.5" to 15", plastic, metal, and stainless steel models as well as the option to use capacitive, resistive or infrared touch panels allow for an extremely wide range of applications.

Unique on the market: XV panels with an onboard SmartWire-DT master interface. This offers potential savings affecting all aspects of a project, from hardware planning to software creation, right up to wiring and commissioning.

# XV300 – The new face of today's industry

Intuitive user guidance, precise gesture-based controls, multi-media integration – the ease of use we experience every day on our smartphones and tablets has now become a reality in industrial applications as well: Our new XV300 panels with capacitive multi-touch technology are not just tremendously intuitive –

they are redefining how man and machine interact. Streamlined, high-resolution devices ready to meet your needs – even in harsh industrial conditions. The devices are cULus type approved



### Versatility and sleek design

- Display sizes: 7" widescreen, 10.1" widescreen, 15.6" widescreen
- Front mounting and rear mounting possible (7" and 10.1")
- Sleek, space-saving design
- Flat front panel made from anti-glare tempered glass
- Can be used either in portrait or landscape mode
- Flush mounted, resulting in a flat surface without any sharp edges
- High system performance and a powerful graphics processing unit
- Visualization via Galileo, CODESYS or Visual Designer
- Integrated web server
- UL and marine certified



### Numerous interfaces and an expandable memory

Flexible network integration, thanks to a wide range of networking and connectivity options. Whether CANopen®, EtherNet/IP, EtherCAT, Modbus (TCP/RTU), PROFIBUS-DP® or SmartWire-DT – the wide range of fieldbus interfaces ensures that the right protocol is available for any application. Where a device has two Ethernet ports that are independent of one another, the open control layer can be safely separated from the function-specific field layer. The device's internal memory can be expanded with an SD memory card. In addition, system updates can be conveniently installed via an SD card. If required, the entire system can be rebooted and run from an SD card.



### A powerful software for project planning

With the project planning tool Galileo, Eaton offers many new possibilities for creating application-specific user interfaces. The use of design themes allows for the creation of uniform user interfaces. Intuitive operation, including gesture control of the swipe, scroll and zoom functions, is now also possible in industrial environments. By activating the Galileo "WebVisu" function, remote devices such as PCs, tablets or smartphones can conveniently access the XV300 visualization. In addition, the system also makes it possible to play videos and to integrate webcams for process monitoring purposes. If devices with integrated PLC functionality are used, the programming is implemented via XSOFT-CODESYS.



### SmartWire-DT on board

SmartWire-DT supports Eaton's concept by helping to create flexible automation solutions with fewer components and less engineering work. How? Simple: SmartWire-DT integrates communications and the I/O layer directly into the corresponding operating units, display devices, and switch-gear. This enables PLCs to use SmartWire-DT to access digital and analog data from sensors all the way to circuit breakers and lets systems efficiently process control commands, eliminating the need for a separate gateway and I/O layer.

# Build it in.

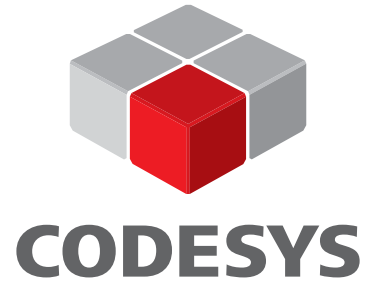
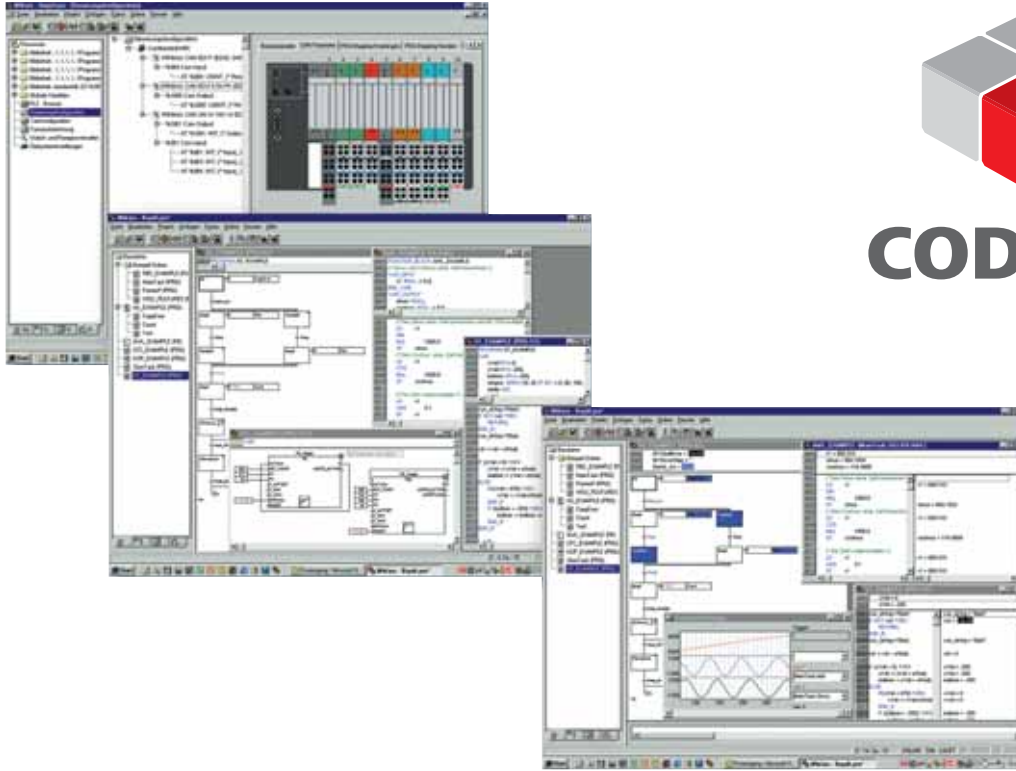

## XSOFT-CODESYS – PLC programming to international standards

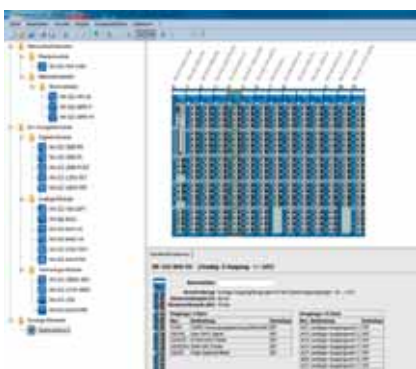

Software tools simplify both project execution and commissioning:

- XN300 Assist
- I/O-Assist
- SWD-Assist

Download free of charge at [www.eaton.eu/software](http://www.eaton.eu/software)



CODESYS is a programming system based on the 3S' CODESYS standard. And with its sophisticated technical features, ease of use, and popularity as a programming system for automation components from a wide variety of manufacturers, it is no surprise that it has become the system of choice for many a successful company. Eaton offers both **CODESYS Version 2** and **Version 3**, and most XV/XC controllers can be programmed with either version.

CODESYS is the ideal programming tool for applications in which a powerful PLC or HMI PLC with various field bus connections is required. The reason why is its integrated field bus configurators for PROFIBUS, CAN, SmartWire-DT, Modbus TCP/RTU (in Version 3), and EtherNet/IP (in Version 3), which make it possible to quickly, intuitively, and easily connect devices to the field bus of your choice. In short, the software is the ideal programming tool for all machine and process-relevant applications in mechanical and plant engineering environments.

SMD-Assist	I/O-Assist	XN300 Assist	CODESYS-3-Webvisu	CODESYS-3	CODESYS-2-Webvisu	CODESYS-2	
							XV-102-B/-D/-E-...
							XV-112...
• <sup>3</sup>							XV-152...
• <sup>3</sup>							XV-3x3-...
							XV(S)-4...
• <sup>3</sup>							XC-152-...
							XC-303
							XC-CPU202-...
							XC-CPU201-...-XV
							XC-CPU201-/101-...
							XC-CPU121
							EC4P-...
		•					XN-PLC-CANOPEN
		•					XN-312-GW-CAN
		•					XNE-GWBR-...
		•					XN-GWBR-...

<sup>3</sup> for devices with SmartWire-DT interface

### Maximum flexibility

CODESYS is the programming tool for all Eaton XV/XC controllers. It enables users to program systems as per IEC-1131-3 with the following programming languages: instruction list (IL), ladder diagram (LD), function block diagram (FBD), sequential function chart (SFC), structured text (ST), continuous function chart (CFC).

Eaton offers targets for the XV100, XV400, XVS400, XC-152, and XC-CPU202 automation systems both for CODESYS V3 and CODESYS V2, meaning that the same hardware can be used in new (configured with CODESYS 3) and existing (programmed with CODESYS 2) machine generations.

### Multitasking

The structuring of the application into several user-defined runtime programs (multitasking) optimizes your PLC's resources and simplifies the implementation of time-critical requirements. This gives high-speed processes priority and slower processes as much processing time as necessary.

### Web visualization

XSOFT CODESYS can generate an XML description based on visualization information. In CODESYS V2, this description will be stored on the controller together with a Java applet. In CODESYS V3, HTML5-based pages (CODESYS V3) will be generated instead. These pages can then be displayed on a browser via TCP/IP.

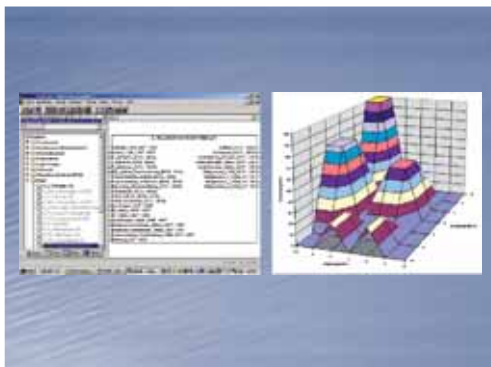

### Application libraries

Eaton Automation offers several ready-to-use libraries for programming PLCs with XSOFT-CODESYS for a wide range of applications:

- Control technology toolbox
- Motion control toolbox
- FTP server
- FTP client
- UDP and TCP/IP
- Modbus RTU/TCP master/slave
- OS functions
- File handling



### XSOFT CODESYS Version 3 features:

- A programming tool that can be expanded using plugins to handle customer-specific adaptations
- Expanded language options (object-oriented programming)
- Know-how protection for targets and the programming tool
- Multiple PLC programs in one project
- New and improved TargetVisu functions
- Improved IT safety functions
- Websites based on HTML5
- Field bus configurations: Modbus TCP/RTU, EtherNet/IP
- SAE J1939 protocol



# Functional safety for persons, machines and the environment



**Safety Technology**

Control the unexpected



A machine poses dangers to persons, machinery and the environment over its entire lifecycle of a machine – from manufacturing to dismantling.

It is therefore vital that dangers are already identified during the design phase of the machine and reduced with suitable measures.

The Machinery Directive 2006/42/EC requires that machines do not pose any dangers. However, as there is no such thing as 100 % safety in engineering, the objective is to reduce these sources of danger to a tolerable level of residual risk. The overall safety of a machine is defined as the state deemed to be free of unwarranted risks to persons or deemed to be free of danger. The functional safety describes the proportion of the overall safety of a system that is dependent on the correct function of the safety-related systems and external devices in order to reduce the risks.

## Risk reduction through the use of safety-related control system components

The elements of machine control that assume safety-related tasks are designated by international standards as "safety-related parts of control systems" (SRP/CS). Safety-related parts of control systems each incorporate the entire functional chain of a safety function, consisting of the input level (sensor), the logic (safe signal processing) and the output level (actuator).

The general objective is to design these parts so that the safety of the control functions as well as the reaction of the control system in the event of a malfunction complies with the degree of risk reduction determined in the risk analysis.

The higher the level of risk reduction to be provided by the safety-related parts of a control system, the higher the safety level or the technical safety performance level demanded of the control section.

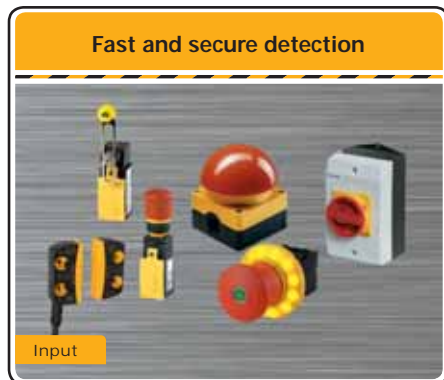

## Safety manual for machines and plants in accordance with EN ISO 13849-1 and IEC 62061

Eaton has written a safety manual for machine and plant builders, trainers and trainees as well as interested customers responsible for "machine and plant safety".

This provides an easy entry level into the extensive range of material on safety technology. The Eaton Safety Manual contains an overview of the most important factors involved in directives, standards and regulations that have to be taken into consideration when using safety equipment on machines. The safety-related contents in this manual have been checked by TÜV Rheinland Industrie Service GmbH.

The manual uses example circuits to show how functional safety can be implemented with electrical, electronic and programmable components and systems in safety applications.

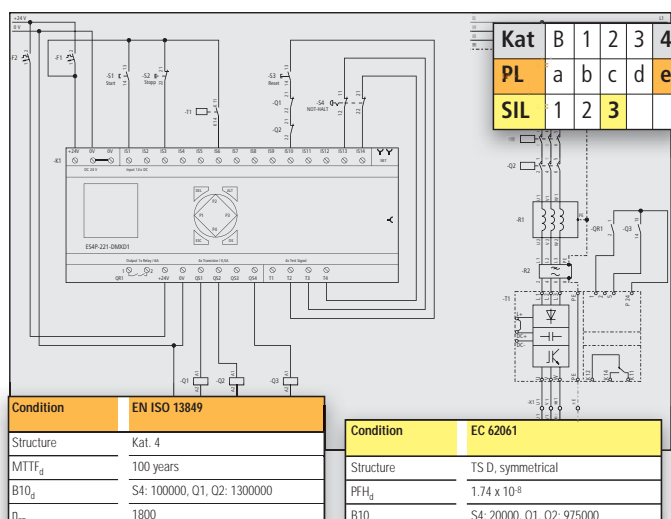

The Safety Manual also provides a description of the functions as well as a clear presentation of a possible evaluation of each circuit example.

The calculated characteristic values apply to the assumptions made in the safety applications and the utilized switchgear.

Simply register at [www.eaton.eu/shb](http://www.eaton.eu/shb) and work online with the safety manual or download a copy free of charge.

For safety-relevant characteristic values of our products, please visit our website [www.eaton.eu/fusi](http://www.eaton.eu/fusi)



# Eaton Configurator xEnergy

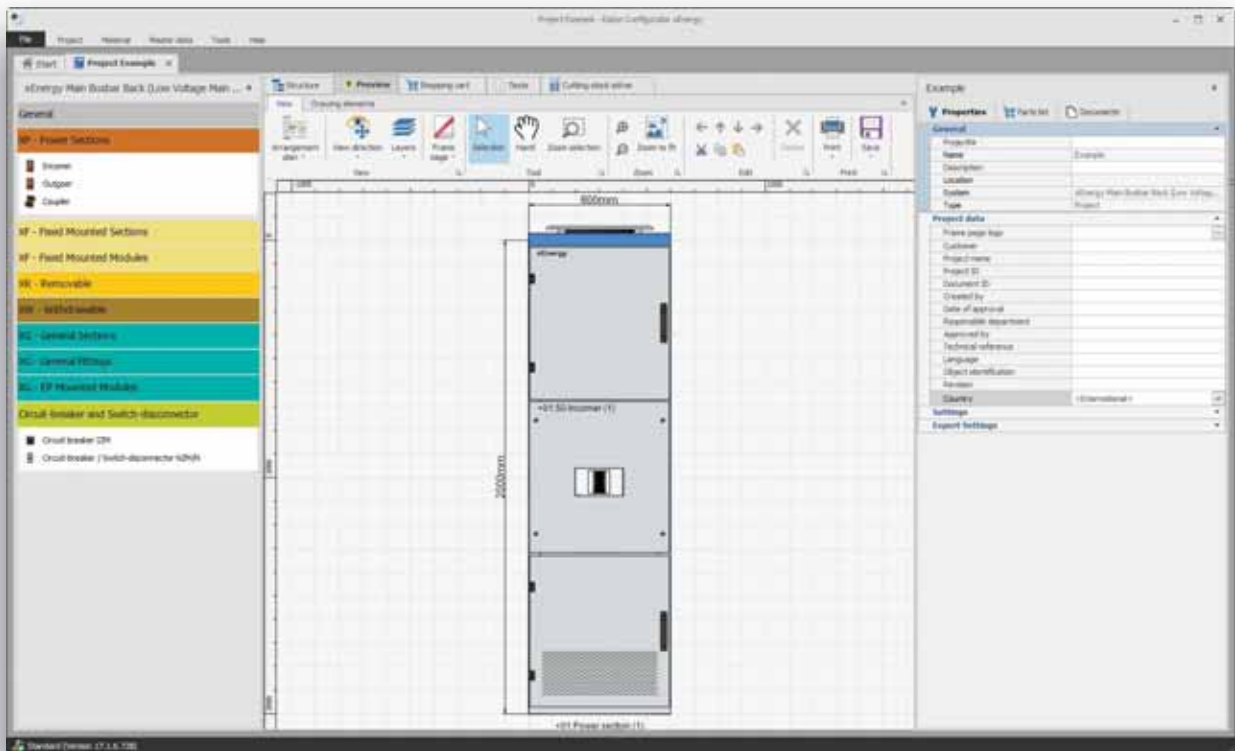

The Eaton xEnergy Configurator is a configuration and pricing software used primarily by panel builders. It supports the design, configuration and cost calculation of low-voltage switchgear assemblies that make use of the xEnergy family of enclosures as well as the IZM and NZM circuit breaker families.





## Main features

### Distribution board configuration

- Fast and reliable configuration of distribution boards systems and circuit protection devices.
- Define technical properties with continuous validation check.
- Function-oriented dimensioning of the distribution board by means of neutral properties.
- Optional transfer of the configured distribution board to ProPlan (detail engineering).

### Preview

- View of the distribution board from different directions.
- View of sections, modules and busbars including dimensioning and drawing sheet.
- Move components via drag/drop.
- Export as DXF file.

### Part lists

- Expandable with any user defined material (including material from "MatClass").

### Documentation

- Access to xEnergy assembly manuals and installation instructions.

### Shopping cart

- As structure and summary parts list.
- Includes the calculation of metal surcharges.
- Considers exchange rates.
- Export to Microsoft Excel.
- Includes recommendations for additionally required busbar material (copper lengths).

## Configurator contents



Configurator is a combined software package that merges a large number of different configuration software packages into one suite:

- xEnergy Basic
- xEnergy Light
- xEnergy Safety
- xEnergy Main (busbar top and busbar back)
- IZM ACB
- NZM MCCB
- Modan

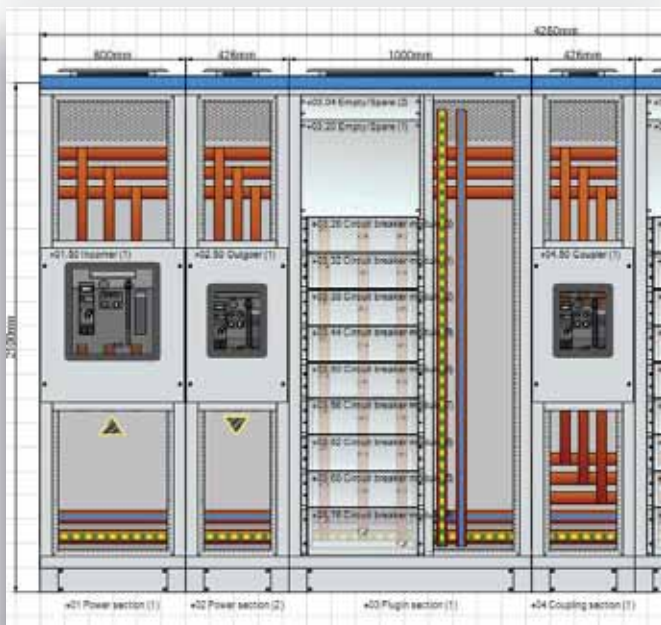

Enclosure and device selection are based on technical features. Configurator includes a front view and supports graphic designing and configuring.

Configurator supports the following devices:

- ACB
- MCCB
- MCB
- RCD
- RCBO
- Accessories

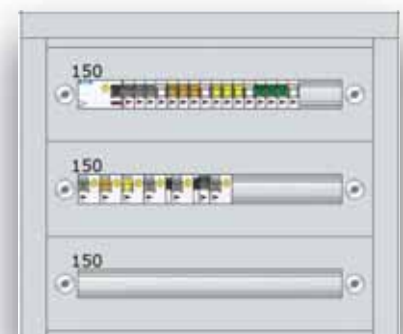



Connect



Setpoint Configuration



Control Mode



Test Mode



Breaker Information



Real Time Data



Event Summaries



Password



Reports



License



Download Language

# Power Xpert Protection Manager







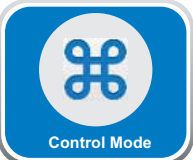

Power Xpert Protection Manager Main Menu

Eaton's Power Xpert Protection Manager (PXPM) provides a clean, intuitive user interface enabling unmatched control, testing, and troubleshooting. The software is free to download and can run on any PC. Settings and tests are communicated to trip units via USB or through connected networks, no special test equipment is required. Troubleshooting is greatly simplified through the use of historical event summaries and real-time data provided by the Power Xpert Release (PXR) trip units. This helps customers to save time and money.

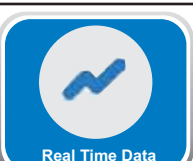
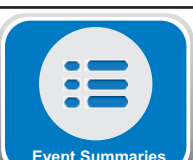
- Eaton's software helps simplify testing, serviceability and customization – yielding significant time and labor savings.
- An enhanced user interface enables engineers to remotely view and adjust the trip unit settings.
- Real-time data: Provides status information and metered data directly from the trip unit.
- Event summaries: Stores up to 200 events, detailed information on most recent (10) trip and (10) alarm events, and time adjustments to the real-time clock.

## Features

	<p>Setpoint Configuration</p> <ul style="list-style-type: none"> <li>- Provides full breaker configuration</li> <li>- Online as well as offline</li> <li>- Offline parameter files</li> </ul>
	<p>Control Mode</p> <ul style="list-style-type: none"> <li>- Parameter reset</li> <li>- Min/max values etc.</li> <li>- Set date and time</li> <li>- Capture waveform</li> </ul>
	<p>Test Mode</p> <ul style="list-style-type: none"> <li>- Perform test features</li> <li>- "Open breaker" – test</li> </ul>
	<p>Breaker Information</p> <ul style="list-style-type: none"> <li>- Provides breaker information details</li> <li>- Trip unit serial number</li> <li>- Trip unit catalog number</li> <li>- Trip unit manufacturing date</li> </ul>
	<p>Real Time Data</p> <ul style="list-style-type: none"> <li>- Provides "online" real-time data</li> <li>- Status, currents, voltages, power</li> <li>- Energy, power demand, min/max values</li> <li>- Diagnostic data</li> </ul>
	<p>Event Summaries</p> <ul style="list-style-type: none"> <li>- Provides event summary and detailed information</li> <li>- Event summary</li> <li>- Trip events in detail</li> <li>- Alarm events in detail</li> <li>- Time adjustments</li> </ul>
	<p>Password</p> <ul style="list-style-type: none"> <li>- Change password of trip unit</li> <li>- Password is required to change sensitive settings</li> <li>- Required for change of protection settings</li> </ul>
	<p>Reports</p> <ul style="list-style-type: none"> <li>- Provides reports as PDF of</li> <li>- Breaker information</li> <li>- Real-time data</li> <li>- Event summary</li> <li>- Setpoint</li> </ul>
	<p>License</p> <ul style="list-style-type: none"> <li>- Some features may require a license</li> <li>- License may be free of charge</li> <li>- License will be connected to specific computer (Hardware identifier)</li> </ul>
	<p>Download Languages</p> <ul style="list-style-type: none"> <li>- Provides future possibility to download further trip unit language packs</li> <li>- Standard languages – EN, DE, CN</li> <li>- Other languages – FR, ES, IT etc.</li> </ul>

Eaton is a power management company with 2018 sales of \$21.6 billion. We provide energy-efficient solutions that help our customers effectively manage electrical, hydraulic and mechanical power more efficiently, safely and sustainably. Eaton is dedicated to improving the quality of life and the environment through the use of power management technologies and services. Eaton has approximately 99,000 employees and sells products to customers in more than 175 countries.

For more information, visit [Eaton.com](http://Eaton.com).



**Eaton Industries (Austria) GmbH**  
Scheydgasse 42  
1210 Vienna  
Austria

**Eaton**  
EMEA Headquarters  
Route de la Longeraie 7  
1110 Morges, Switzerland  
[Eaton.eu](http://Eaton.eu)

© 2019 Eaton  
All Rights Reserved  
Printed in Austria  
Publication No.: CA013003EN  
Article no. 195248-MK  
November 2019  
Graphics: SRA, Schrems

Changes to the products, to the information contained in this document, and to prices are reserved; as are errors and omissions. Only order confirmations and technical documentation by Eaton is binding. Photos and pictures also do not warrant a specific layout or functionality. Their use in whatever form is subject to prior approval by Eaton. The same applies to trademarks (especially Eaton, Moeller, and Cutler-Hammer). The Terms and Conditions of Eaton apply, as referenced on Eaton Internet pages and Eaton order confirmations.

Eaton is a registered trademark.

All other trademarks are property of their respective owners.

Follow us on social media to get the latest product and support information.

